

Leica GKL221

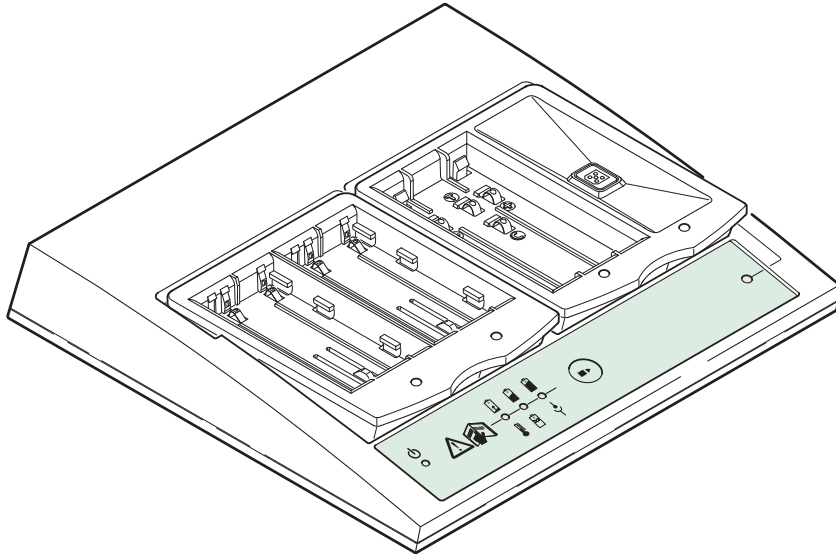

V 1.3

- when it has to be **right**

Leica
Geosystems

DE

EN

FR

ES

IT

PT

DA

NO

NL

SV

FI

JA

ZH

KO

Leica GKL221 Ladestation

Gebrauchsanweisung

DE

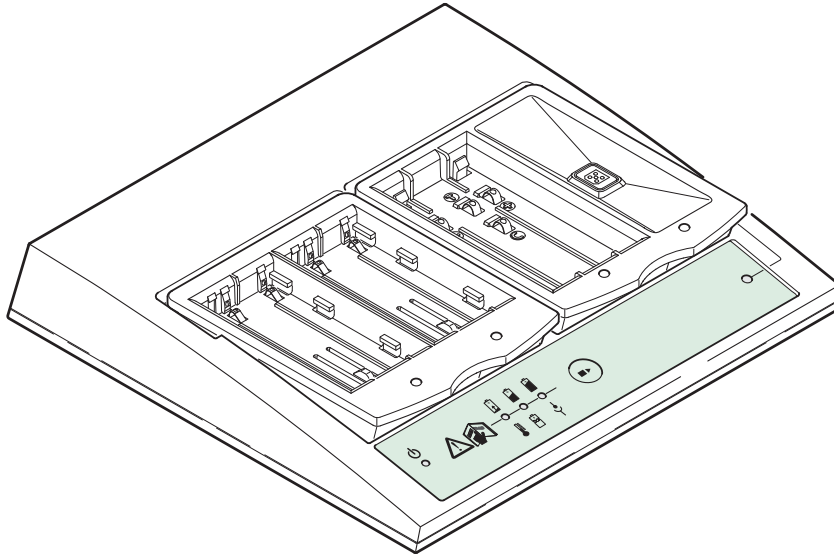

Version 1.3
Deutsch

- when it has to be **right**

Leica
Geosystems

Einleitung



Diese Gebrauchsanweisung enthält neben den Hinweisen zur Verwendung auch wichtige Sicherheitshinweise. Siehe Kapitel "4 Sicherheitshinweise" für weitere Informationen. Lesen Sie die Gebrauchsanweisung vor der Inbetriebnahme des Produkts sorgfältig durch.

Produktidentifizierung

Die Typenbezeichnung und die Seriennummer Ihres Produktes ist auf dem Typenschild angebracht. Übertragen Sie diese Angaben in Ihre Gebrauchsanweisung und beziehen Sie sich immer auf diese Angaben, wenn Sie Fragen an unsere Vertretung oder eine von Leica Geosystems autorisierte Servicestelle haben.

Typ: _____

Seriennr.: _____

Verwendete Symbole

Die in dieser Gebrauchsanweisung verwendeten Symbole haben folgende Bedeutung:

Art	Beschreibung
Gefahr	Unmittelbare Gebrauchsgefahr, die zwingend schwere Personenschäden oder den Tod zur Folge hat.
Warnung	Gebrauchsgefahr oder sachwidrige Verwendung, die schwere Personenschäden oder den Tod bewirken kann.
Vorsicht	Gebrauchsgefahr oder sachwidrige Verwendung, die nur geringe Personenschäden, aber erhebliche Sach-, Vermögens- oder Umweltschäden bewirken kann.
	Nutzungsinformation, die dem Benutzer hilft, das Produkt technisch richtig und effizient einzusetzen.

Inhaltsverzeichnis

Inhalt	Kapitel	Seite
	1 Systembeschreibung	4
	2 Bedienung	8
	2.1 Batterieadapter	8
	2.2 Ladestation anschliessen	9
	2.3 Batterien einsetzen und entnehmen	11
	2.4 Wahltaete	14
	2.5 Batterie laden	15
	2.6 Leuchtanzeigen	17
	2.7 Tips	20
	3 Wartung und Transport	21
	3.1 Transport	21
	3.2 Lagerung	21
	3.3 Reinigen und Trocknen	21
	4 Sicherheitshinweise	22
	4.1 Generelles	22
	4.2 Verwendungszweck	22
	4.3 Einsatzgrenzen	23
	4.4 Verantwortungsbereiche	23
	4.5 Gebrauchsgefahren	24
	4.6 Elektromagnetische Verträglichkeit EMV	25
	4.7 FCC Hinweis, Gültig in USA	26
	5 Technische Daten	28

Beschreibung

GKL221 von Leica Geosystems ist eine intelligente Ladestation mit fortschrittlicher Ladetechnologie. Sie eignet sich zum Laden aller Leica Geosystems Batterien sowohl am Stromnetz als auch im Kraftfahrzeug über den KFZ-Adapter GDC221. Die Ladestation stellt eine optimale Ergänzung des batteriebetriebenen Leica Geosystems Produktes dar.

Allgemeine Informationen

An die Ladestation können bis zu fünf Batterien angeschlossen werden.

Es können gleichzeitig zwei Batterien geladen werden. Die Batterien werden in der Reihenfolge des Anschliessens geladen.

Die Ladestation erlaubt neben dem Laden von Batterien weitere Funktionen wie Entladen, Erhaltungsladen oder das Auffrischen von Batterien.



Es wird empfohlen, das Produkt in Betrieb zu nehmen, während Sie diese Gebrauchsanweisung lesen.

Systembestandteile

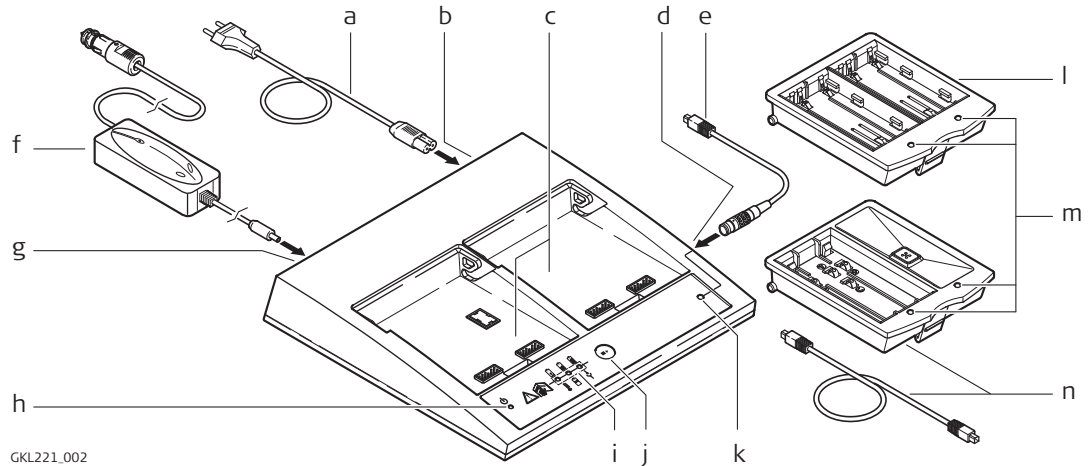

GKL221_002

- a) Länderspezifisches Netzkabel
- b) Anschluss für Netzkabel
- c) Schächte I und II für Batterieadapter GDI221 / GDI222
- d) Externer Batterieanschluss
- e) Ladekabel für externe 5-Pol Batterie
- f) KFZ-Adapter GDC221, Option
- g) Anschluss für KFZ-Adapter
- h) Betriebsanzeige
- i) Kapazitäts- und Fehleranzeigen
- j) Wahltaste
- k) Zustandsanzeige für externen Batterieanschluss
- l) Batterieadapter GDI221, Option
- m) Zustandsanzeigen der Batterien
- n) Batterieadapter GDI222 und passendes 5-Pol Ladekabel, Option

Aufladbare Batterien

Folgende Leica Geosystems Batterien können geladen werden:

GEB90
GEB211
GEB212
GEB221
GEB222
GEB241
GEB242



GEB111
GEB121

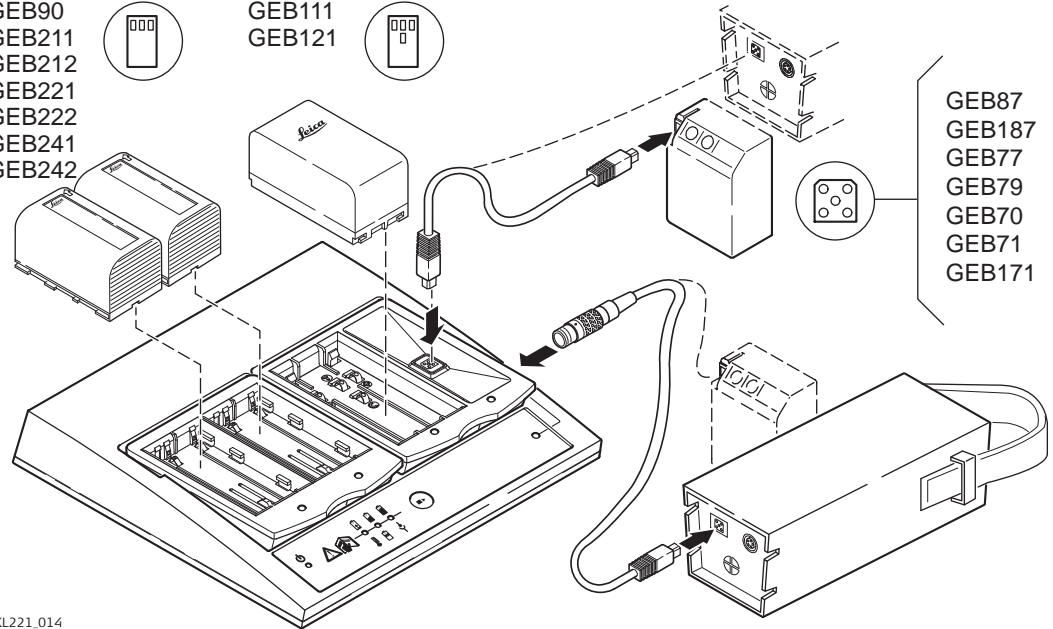

GEB87
GEB187
GEB77
GEB79
GEB70
GEB71
GEB171

GKL221_014



Die Ladestation ist nur für das Laden und Entladen von original Leica Geosystems Batterien sowie verschiedener handelsüblicher NiMH/NiCd Camcorderbatterien geeignet. Siehe Kapitel "2.3 Batterien einsetzen und entnehmen" für weitere Informationen.

Ladestation und Batterieadapter

Die möglichen Kombinationen der Ladestation mit den Batterieadaptern erlauben das Anschliessen und Laden folgender Batterien:

Ladestation / Batterieadapter	Aufladbare Batterien
GKL221 mit zwei GDI221	Bis zu vier Li-Ion Batterien und eine Batterie mit 5-Pol Ladebuchse.
GKL221 mit einem GDI221 und einem GDI222	Bis zu zwei Li-Ion Batterien, eine Batterie im Camcorderformat und zwei Batterien mit 5-Pol Ladebuchse.
GKL221 mit zwei GDI222	Bis zu zwei Batterien im Camcorderformat und drei Batterien mit 5-Pol Ladebuchse.

DE

2

2.1

Bedienung

Batterieadapter

DE

Zweck

Die Batterieadapter dienen zur Verbindung der Ladestation mit den entsprechenden Batterien und enthalten pro Ladeschacht eine LED für die Zustandsanzeige der Batterie.

Typen

Folgende Batterieadapter sind verfügbar:

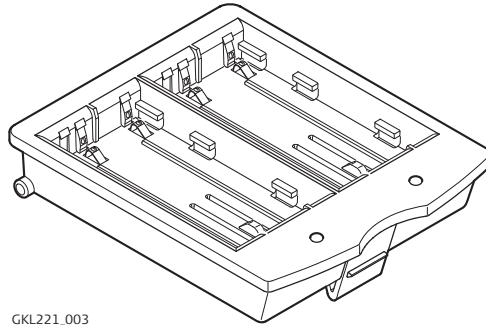

GKL221_003

GDI221

- Für zwei Leica Geosystems Li-Ion Batterien GEB90, GEB211, GEB212, GEB221, GEB222, GEB241 oder GEB242.

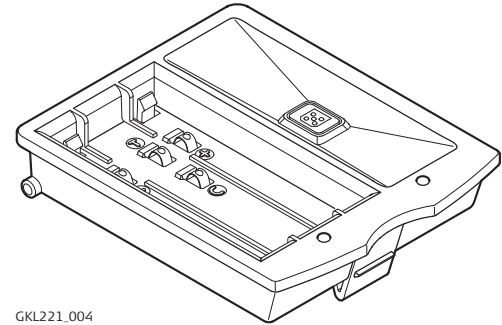

GKL221_004

GDI222

- Für eine Leica Geosystems NiMH Batterie GEB111 oder GEB121 sowie eine NiCd oder NiMH 5-Pol Batterie.

Einsetzen, entnehmen

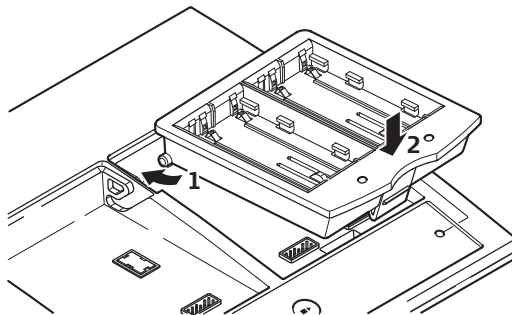

GKL221_005

Einsetzen

1. Batterieadapter mit der hinteren Führung einsetzen.
2. Durch Druck auf den vorderen Bereich einrasten. Das Einrasten ist deutlich hör- und fühlbar.

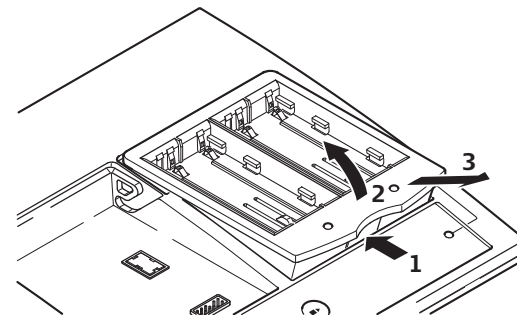

GKL221_006

Entnehmen

1. Batterieadapter durch Drücken der vorderen Lasche entriegeln.
2. Leicht bis zum Anschlag nach oben ziehen.
3. Den Adapter nach vorne entnehmen.

2.2

Ladestation anschliessen



Warnung

Ladestation nur in trockenen Innenräumen verwenden! Nasse und mit Feuchtigkeit beschlagene Geräte dürfen nicht verwendet werden!

Inbetriebnahme

Sorgen Sie vor der Inbetriebnahme immer für einen festen Stand des Gerätes.

Verbinden Sie die Ladestation entweder:

- über das mitgelieferte Netzkabel mit dem Stromnetz oder
- über den optional erhältlichen KFZ-Adapter GDC211 mit dem Bordnetz des KFZ.



Zur sicheren Trennung vom Stromnetz und wenn die Ladestation längere Zeit nicht in Gebrauch ist, ist der Stecker des Netzkabels beziehungsweise der Stecker des KFZ-Adapters zu ziehen.



Speisung der Ladestation mittels KFZ-Adapter nur über KFZ-Bordnetze. Bei Speisung durch andere Netze, zum Beispiel strombegrenzende Netzgeräte, können Fehlfunktionen auftreten. Siehe Kapitel "5 Technische Daten" für Informationen zu Eingangsspannung und Nennleistung.



Bei älteren Kraftfahrzeugen auf die richtige Polung des Zigarettenanzündersteckers achten, das heisst +Pol auf Mittelkontakt. Bei falscher Polung muss die Sicherung in der Ladestation oder die Sicherung im KFZ-Adapter ausgetauscht werden. Die Sicherung in der Ladestation muss durch eine von Leica Geosystems autorisierte Servicestelle ausgetauscht werden. Der Austausch der Sicherung im KFZ-Adapter ist gemäss Bedienungsanleitung des KFZ-Adapters durchzuführen.

Funktionskontrolle

Nach dem Verbinden mit dem Netz oder dem KFZ-Bordnetz leuchten die Zustandsanzeigen der Batterieadapter einmal rot, gelb und grün, die Kapazitäts- und Fehleranzeigen rot und grün auf. Dies dient der Funktionskontrolle.

Ist keine Batterie angeschlossen, leuchtet anschliessend nur noch die Betriebsanzeige grün. Sollten die Zustandsanzeigen und die drei Kapazitäts- und Fehleranzeigen dauerhaft rot aufleuchten, hat das Gerät einen Defekt festgestellt. Siehe Kapitel "2.6 Leuchtanzeigen" für weitere Informationen.

2.3

Batterien einsetzen und entnehmen

Li-Ion Batterien

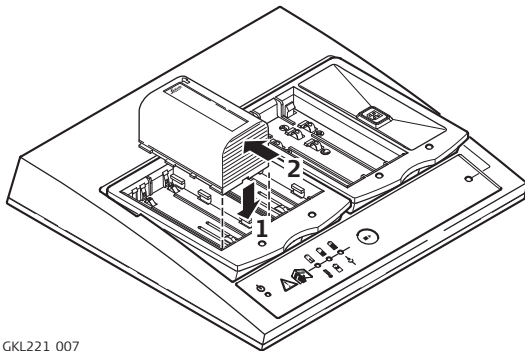

GKL221_007

Einsetzen:

1. Batterie bündig mit der Vorderkante des Batterieschachtes GDI221 einlegen.
2. Batterie mit leichtem Druck nach unten bis zum Anschlag vor schieben.

Entnehmen:

- Batterie bis zum Anschlag zurückziehen und entnehmen.

Warnung

Laden beziehungsweise Entladen Sie mit der Ladestation nur Batterien, die von Leica Geosystems empfohlen werden. Verwenden Sie ausschliesslich Li-Ion Batterien von Leica Geosystems.

NiCd und NiMH Batterien

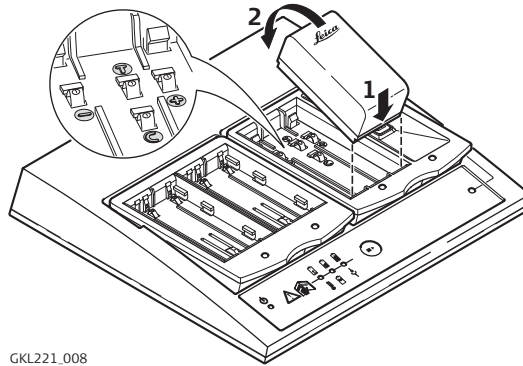

GKL221_008

Einsetzen:

1. Batterie an der Vorderkante des Batterieschachtes GDI222 anlegen.
2. Nach unten drücken, bis ein deutliches Einrasten zu hören und zu fühlen ist.

Entnehmen:

- Batterie an der hinteren Seite nach oben ziehen und entnehmen.



Die Leica Geosystems Batterien GEB111 und GEB121 haben vier Kontaktflächen, Camcorderbatterien anderer Hersteller nur drei. Die Ladestation kann zwischen diesen Typen unterscheiden und das Ladeverfahren anpassen.



Camcorderbatterien mit drei Kontaktflächen müssen folgende Bedingungen erfüllen, um Beschädigungen zu vermeiden:

- Spannung: 6 V
- Zellart: NiCd oder NiMH
- Minimumkapazität: NiCd 1500 mAh, NiMH 1800 mAh
- kompatible Kontakte in korrekter Anordnung, das heisst "+, T, -" in einer Reihe

Camcorderbatterien, die diesen Bedingungen entsprechen, werden temperaturüberwacht mit einem Ladestrom von 1.6 A geladen.

Batterien mit 5-Pol Ladebuchse

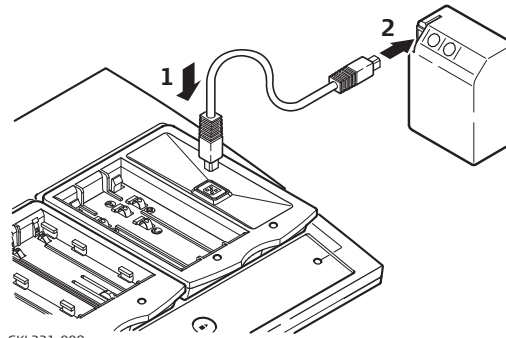

GKL221_009

Leica Geosystems Batterien mit 5-Pol Ladebuchse, zum Beispiel GEB87 oder GEB70, werden über das Ladekabel an die 5-Pol Ladebuchse angeschlossen.

DE

Externe Batterien mit 5-Pol Ladebuchse

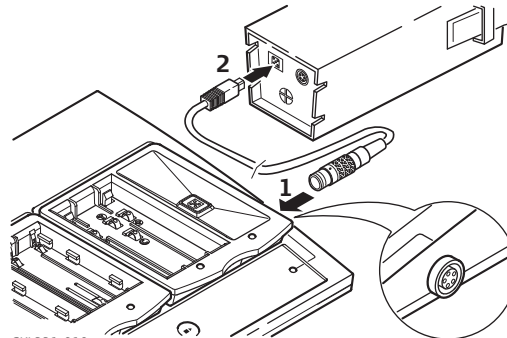

GKL221_010

Leica Geosystems Batterien mit 5-Pol Ladebuchse, zum Beispiel GEB87 oder GEB70, werden über das Ladekabel an den externen Batterieanschluss angeschlossen.

 Batterien am externen Batterieanschluss werden bevorzugt geladen, ohne einen bereits begonnenen Ladevorgang zu unterbrechen.

2.4

Wahltaste

Funktion

DE

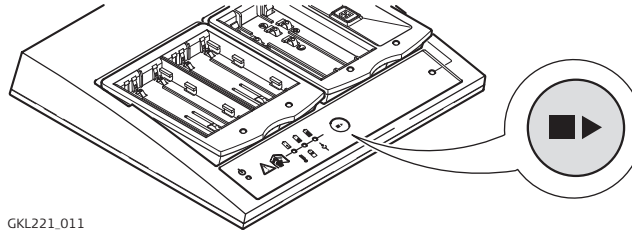

GKL221_011

Die Wahl­tas­te dient der Aus­wahl eines Lade­schach­tes sowie zum Umschal­ten zwi­schen Laden und Entladen.

Funktion	Wahl­tas­te drücken	Beschreibung
Lade­schacht wählen	kürzer als zwei Sekunden	Der näch­ste, mit einer Batterie bestückte Schacht wird aus­ge­wählt. Der ge­wähl­te Schacht wird durch schnel­les, gelbes Blinken der Zustands­an­zeige für cir­ca drei Sekunden ange­zeigt, weite­rs wird die Kapazität der Batterie ange­zeigt.
Umschal­ten zwi­schen Laden und Entladen	länger als drei Sekunden	Beim Umschal­ten auf Entlade­modus blinkt die Zustands­an­zeige gelb-rot, beim Umschal­ten in den Lade­modus dage­gen gelb-grün, für je­weils cir­ca fünf Sekunden.



Entladen wird durch rotes Blinken der Zustands­an­zeige ange­zeigt. Ist der Entlade­vorgang abge­schlossen, wech­sel­te die Zustands­an­zeige wie­der auf Grün, das heisst die Batterie wird geladen.

2.5

Batterie laden

Vorgehen

Schritt	Beschreibung
1.	Batterieadapter einsetzen.
2.	Ladestation an Stromversorgung anschliessen, die Betriebsanzeige leuchtet grün.
3.	Batterie einsetzen. Die Zustandsanzeige blinkt gelb, das heisst die Batterie ist erkannt.
4.	Vergewissern Sie sich, dass die Zustandsanzeige dauernd grün leuchtet. Die Batterie wird jetzt geladen. Siehe Kapitel "2.6 Leuchtanzeigen", sollte sich nach dem Anschliessen der Batterie eine andere Zustandsanzeige einstellen.  Überprüfen Sie die Zustandsanzeige nach circa einer Minute erneut.
5.	Die Batterie ist vollständig geladen, wenn die Zustandsanzeige grün blinkt. Siehe Kapitel "5 Technische Daten" für Informationen zu den Ladezeiten.
6.	Die Batterie kann entnommen werden oder angeschlossen bleiben, so dass sie bei Bedarf geladen zur Verfügung steht. Siehe Kapitel "Ladearten" für weitere Informationen.

Ladereihenfolge festlegen

Die Ladestation GKL221 kann zwei Batterien gleichzeitig laden. Wird mehr als eine Batterie an die Ladestation angeschlossen, so werden die Batterien in der Anschlussreihenfolge geladen. Schliessen Sie daher zuerst die dringendst benötigten Batterien an.

Prioritäten



Über den externen Batterieanschluss wird bevorzugt geladen, ohne einen bereits begonnenen Ladevorgang zu unterbrechen.

Erhaltungsladung

Sind angeschlossene Batterien vollgeladen, so können diese angeschlossen bleiben. Für NiCd und NiMH Batterien wird sequentiell ein Erhaltungsladen durchgeführt. So wird die technisch bedingte Selbstentladung der Batterien kompensiert und die Batterien stehen mit voller Kapazität zur Verfügung. Siehe Kapitel "Ladearten" für weitere Informationen.

Batterie auffrischen



Die Auffrischfunktion besteht aus einem völligen Entladen der Batterie mit anschliessendem Schnellladen.

Schritt	Beschreibung
1.	Ladestation an Stromversorgung anschliessen.
2.	Batterie einsetzen. Die Zustandsanzeige blinkt gelb, das heisst die Batterie ist erkannt.
3.	Länger als drei Sekunden auf die Wahltaste drücken; das Entladen der gewählten Batterie wird gestartet. Das Entladen wird durch rotes Blinken der Zustandsanzeige angezeigt.  Bei Batterien mit hoher Kapazität kann das Entladen sehr lange dauern. Zur Verminderung der Entladezeiten sollte diese Funktion nur bei leeren beziehungsweise fast leeren Batterien erfolgen!
4.	Ist die Batterie fertig entladen, wird sie automatisch schnellgeladen. Die Zustandsanzeige leuchtet dann grün.
5.	Die Batterie ist vollständig geladen, wenn die Zustandsanzeige grün blinkt.
	Wir empfehlen NiCd und NiMH Batterien zwei- bis dreimal der Auffrischfunktion zu unterziehen, wenn die Kapazität einer Batterie merklich sinkt.
	Bei Li-Ion Batterien reicht ein einmaliger Entlade- und Ladezyklus. Wir empfehlen dies durchzuführen, wenn die angezeigte Batteriekapazität auf dem Ladegerät oder einem Leica Geosystems Produkt gegenüber der tatsächlich zur Verfügung stehenden Kapazität stark abweicht.



2.6

Leuchtanzeigen





Erklärung der Symbole



Symbol	Bedeutung
	LED aus.
	LED leuchtet permanent.
	LED blinkt.

Betriebsanzeige

Symbol	LED	Bedeutung
	Aus	Ladestation ist nicht an eine Stromquelle angeschlossen.
	Grün	Ladestation ist an eine Stromquelle angeschlossen.

Zustandsanzeigen

Symbol	LED	Bedeutung
	Aus	Keine Batterie am Anschluss erkannt.
	Gelb	Die Ladestation hat eine Batterie am Anschluss erkannt. Sie befindet sich im Wartezustand, da momentan zwei andere Batterien ge- oder entladen werden.
	Grün	Die angeschlossene Batterie wird geladen.
	Grün	Die angeschlossene Batterie ist vollgeladen und kann entnommen werden.





Symbol	LED	Bedeutung
	Rot	Die Ladestation hat einen Fehler erkannt.
	Rot	Batterie zum Auffrischen angeschlossen. Sie befindet sich in der Entladephase.
	Gelb	Anzeige des aktiven, d.h des ausgewählten Schachtes.

Kapazitäts- und Fehleranzeigen

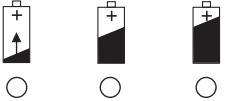
- Im Normalbetrieb zeigen die drei Kapazitäts- und Fehleranzeigen die Kapazität der Batterie im gewählten Schacht grün an. Die Anzeige wird nach Wahl eines Schachtes für circa zehn bis fünfzehn Sekunden sichtbar, danach erlischt sie.
- Im Fehlerfall zeigen die Kapazitäts- und Fehleranzeigen den Fehlercode für den gewählten Schacht in roter Farbe an.

Kapazitätsanzeigen











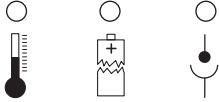



LEDs	Bedeutung
	Ladezustand der Batterie weniger als 20%.
	Ladezustand der Batterie mindestens 20%.
	Ladezustand der Batterie mindestens 50%.
	Ladezustand der Batterie mindestens 80%.



Die Kapazitätsanzeige ist derzeit nur bei den Leica Geosystems Batterien GEB211, GEB212, GEB221, GEB222, GEB241, GEB242 und GEB90 möglich.

Fehleranzeigen



LEDs	Bedeutung	Massnahmen
  	Unter- oder Übertemperaturfehler der Batterie.	Siehe Kapitel "Temperaturbereich" für weitere Informationen.
  	Batterie defekt.	Andere Batterie verwenden.
  	Fehlerhafter Kontakt bei Batterie oder Batterieadapter.	Kontakte überprüfen.
  	Hardwarefehler Ladestation.	Kontaktieren Sie eine von Leica Geosystems autorisierte Servicestelle.



Wenn die Ladestation bei angeschlossener Batterie einen Fehler anzeigt:

- Schliessen Sie eine andere Batterie an, um festzustellen, ob die Störung in der Batterie oder in der Ladestation vorliegt.
- Kann das Problem nicht behoben werden, benachrichtigen Sie eine von Leica Geosystems autorisierte Servicestelle.



Bei Fehlfunktionen überprüfen Sie bitte auch:

- Ist die Stromversorgung über Netzsteckdose beziehungsweise KFZ-Bordnetz vorhanden?
- Sind die Kabel ordnungsgemäss eingesteckt und keine offensichtlichen Mängel erkennbar?
- Bei optional angeschlossenen KFZ-Adapter:
Leuchtet die Betriebsleuchte des KFZ-Adapters?

2.7

Tips

Tips

DE



-
- Um die Kapazität der Batterie voll auszuschöpfen, sollten Sie neue NiCd und NiMH Batterien drei- bis fünfmal vollständig Laden und Entladen.
 - Batterien im Instrument möglichst tief entladen. Dies vermeidet bei NiCd Batterien den "Memory Effekt".
 - Bei Verwendung des KFZ-Adapters sollten Batterien nur bei laufendem Motor geladen werden.
-

Vermeiden Sie schnelle Erhöhungen der Umgebungstemperatur während dem Laden, zum Beispiel durch Sonneneinstrahlung auf Ladestationen und Batterien. Schnelle Erhöhungen der Umgebungstemperatur können ein vorzeitiges Ladeende mit reduzierter Batteriekapazität verursachen.

3 **Wartung und Transport**

3.1 **Transport**

Versand

Verwenden Sie beim Versand per Bahn, Flugzeug oder Schiff immer die komplette Leica Geosystems-Originalverpackung, Transportbehälter und Versandkarton, beziehungsweise entsprechende Verpackungen.

Die Verpackung sichert das Produkt gegen Schläge und Vibrationen.

3.2 **Lagerung**

Produkt

Lagertemperaturbereich bei der Lagerung Ihrer Ausrüstung beachten, speziell im Sommer, wenn Sie Ihre Ausrüstung im Fahrzeuginnenraum aufbewahren. Siehe Kapitel "5 Technische Daten" für Informationen über den Lagertemperaturbereich.

3.3 **Reinigen und Trocknen**

Produkt

Nur mit einem sauberen und weichen Lappen reinigen.

Kabel und Stecker

Stecker dürfen nicht verschmutzen und sind vor Nässe zu schützen. Verschmutzte Stecker der Verbindungskabel ausblasen.

4

4.1

Sicherheitshinweise

Generelles

Beschreibung

Diese Hinweise sollen Betreiber und Benutzer in die Lage versetzen, allfällige Gebrauchsgefahren rechtzeitig zu erkennen, das heisst möglichst im Voraus zu vermeiden.

Der Betreiber hat sicherzustellen, dass alle Benutzer diese Hinweise verstehen und befolgen.

4.2

Verwendungszweck

Bestimmungsgemässe Verwendung

- Laden und Entladen von Batterien mit unterschiedlichen Zelltechnologien.
-

Sachwidrige Verwendung

- Verwendung des Produktes ohne Instruktion
- Verwendung ausserhalb der Einsatzgrenzen
- Unwirksammachen von Sicherheitseinrichtungen
- Entfernen von Hinweis- oder Warningschildern
- Öffnen des Produktes mit Werkzeugen, zum Beispiel Schraubenzieher, sofern nicht ausdrücklich für bestimmte Fälle erlaubt
- Durchführung von Umbauten oder Veränderungen am Produkt
- Inbetriebnahme nach Entwendung
- Verwendung des Produktes mit offensichtlich erkennbaren Mängeln oder Schäden
- Verwendung von Zubehör anderer Hersteller, das von Leica Geosystems nicht ausdrücklich genehmigt ist.

Warnung

Möglichkeit einer Verletzung, einer Fehlfunktion und Entstehung von Sachschaden bei sachwidriger Verwendung.

Der Betreiber informiert den Benutzer über Gebrauchsgefahren des Produktes und schützende Gegenmassnahmen. Das Produkt darf erst dann in Betrieb genommen werden, wenn der Benutzer instruiert ist.

4.3

Einsatzgrenzen

Umwelt

Einsatz nur in trockenen Innenräumen mit nicht rauher Umgebung zulässig.

4.4

Verantwortungsbereiche

Hersteller des Produktes

Leica Geosystems AG, CH-9435 Heerbrugg, kurz Leica Geosystems, ist verantwortlich für die sicherheitstechnisch einwandfreie Lieferung des Produktes inklusive Gebrauchsanweisung und Originalzubehör.

Hersteller von Fremdzubehör

Hersteller von Fremdzubehör für das Produkt sind verantwortlich für die Entwicklung, Umsetzung und Kommunikation von Sicherheitskonzepten für ihre Produkte und deren Wirkung in Kombination mit dem Leica Geosystems Produkt.

Betreiber

Für den Betreiber gelten folgende Pflichten:

- Er versteht die Schutzinformationen auf dem Produkt und die Instruktionen in der Gebrauchsanweisung.
 - Er kennt die ortsüblichen, betrieblichen Sicherheits- und Unfallverhütungsvorschriften.
 - Er benachrichtigt Leica Geosystems, sobald am Produkt und in dessen Anwendung Sicherheitsmängel auftreten.
-

Warnung

Der Betreiber ist verantwortlich für die bestimmungsgemässe Verwendung des Produktes, den Einsatz seiner Mitarbeiter, deren Instruktion und die Betriebssicherheit des Produktes.

 **Warnung**

Fehlende oder unvollständige Instruktion können zu Fehlbedienung oder sachwidriger Verwendung führen. Dabei können Unfälle mit schweren Personen-, Sach-, Vermögens- und Umweltschäden entstehen.

Gegenmassnahmen:

Alle Benutzer befolgen die Sicherheitshinweise des Herstellers und Weisungen des Betreibers.

 **Warnung**

Das Produkt ist nicht für den Betrieb in nasser und rauher Umgebung ausgelegt. Sie können einen elektrischen Schlag erleiden, wenn Feuchtigkeit in das Produkt eindringt.

Gegenmassnahmen:

Betreiben Sie das Produkt nur in trockenen Innenräumen, zum Beispiel Gebäude oder Kraftfahrzeug. Schützen Sie das Produkt vor Feuchtigkeit. Nass gewordene Produkte dürfen nicht verwendet werden!

 **Warnung**

Wenn Sie das Produkt öffnen, können Sie durch folgende Auslöser einen elektrischen Schlag erleiden:

- Berühren von stromführenden Teilen.
- Betrieb nach sachwidrigem Reparaturversuch.

Gegenmassnahmen:

Das Produkt nicht öffnen. Lassen Sie es nur von einer von Leica Geosystems autorisierten Service-stelle reparieren.

 **Warnung**

Beim Laden beziehungsweise Entladen von Batterien, die von Leica Geosystems nicht empfohlen sind, können Batterien beschädigt werden. Dies kann zu Brand- und Explosionsgefahren führen.

Gegenmassnahmen:

Laden beziehungsweise Entladen Sie nur Batterien, die von Leica Geosystems empfohlen werden.

Warnung

Bei unsachgemässer Entsorgung des Produktes können folgende Ereignisse eintreten:

- Beim Verbrennen von Kunststoffteilen entstehen giftige Abgase, an denen Personen erkranken können.
- Batterien können explodieren und dabei Vergiftungen, Verbrennungen, Verätzungen oder Umweltverschmutzung verursachen, wenn sie beschädigt oder stark erwärmt werden.
- Bei leichtfertigem Entsorgen ermöglichen Sie unberechtigten Personen, das Produkt sachwidrig zu verwenden. Dabei können Sie sich und Dritte schwer verletzen sowie die Umwelt verschmutzen.

Gegenmassnahmen:



Das Produkt darf nicht im Hausmüll entsorgt werden.

Entsorgen Sie das Produkt sachgemäß. Befolgen Sie die nationalen, länderspezifischen Entsorgungsvorschriften.

Schützen Sie das Produkt jederzeit vor dem Zugriff unberechtigter Personen.

Produktspezifische Informationen zur Behandlung und Entsorgung stehen auf der Homepage von Leica Geosystems unter <http://www.leica-geosystems.com/treatment> zum Download bereit oder können bei Ihrem Leica Geosystems Händler angefordert werden.

4.6

Elektromagnetische Verträglichkeit EMV

Beschreibung

Als elektromagnetische Verträglichkeit bezeichnen wir die Fähigkeit des Produktes, in einem Umfeld mit elektromagnetischer Strahlung und elektrostatischer Entladung einwandfrei zu funktionieren, ohne elektromagnetische Störungen in anderen Geräten zu verursachen.

Warnung

Möglichkeit einer Störung anderer Geräte durch elektromagnetische Strahlung.

Obwohl die Produkte die strengen Anforderungen der einschlägigen Richtlinien und Normen erfüllen, kann Leica Geosystems die Möglichkeit einer Störung anderer Geräte nicht ganz ausschliessen.

Vorsicht

Möglichkeit einer Störung anderer Geräte wenn Sie das Produkt in Kombination mit Fremdgeräten verwenden, zum Beispiel diverse Kabel oder externe Batterien.

Gegenmassnahmen:

Verwenden Sie nur die von Leica Geosystems empfohlene Ausrüstung oder Zubehör. Sie erfüllen in Kombination mit dem Produkt die strengen Anforderungen der einschlägigen Richtlinien und Normen.

Warnung

Bei Betreiben des Produktes mit einseitig eingestecktem Kabel, zum Beispiel externes Speisekabel, kann eine Überschreitung der zulässigen elektromagnetischen Strahlungswerte auftreten und dadurch andere Geräte gestört werden.

Gegenmassnahmen:

Während des Gebrauchs des Produktes müssen Kabel beidseitig eingesteckt sein, zum Beispiel Gerät / externe Batterie.

4.7

FCC Hinweis, Gültig in USA

Warnung

Dieses Produkt hat in Tests die Grenzwerte eingehalten, die in Abschnitt 15 der FCC-Bestimmungen für digitale Geräte der Klasse B festgeschrieben sind.

Diese Grenzwerte sehen für die Installation in Wohngebieten einen ausreichenden Schutz vor störenden Abstrahlungen vor.

Geräte dieser Art erzeugen und verwenden Hochfrequenzen und können diese auch ausstrahlen. Sie können daher, wenn sie nicht den Anweisungen entsprechend installiert und betrieben werden, Störungen des Rundfunkempfanges verursachen.

Es kann aber nicht garantiert werden, dass bei bestimmten Installationen nicht doch Störungen auftreten können.

Falls dieses Gerät Störungen des Radio- oder Fernsehempfangs verursacht, was durch Aus- und Wiedereinschalten des Gerätes festgestellt werden kann, ist der Benutzer angehalten, die Störungen mit Hilfe folgender Massnahmen zu beheben:

- Die Empfangsantenne neu ausrichten oder versetzen.
- Den Abstand zwischen Gerät und Empfänger vergrössern.
- Das Gerät an die Steckdose eines Stromkreises anschliessen, der unterschiedlich ist zu dem des Empfängers.
- Lassen Sie sich von Ihrem Händler oder einem erfahrenen Radio- und Fernsichtechner helfen.

! Warnung

Änderungen oder Modifikationen, die nicht ausdrücklich von Leica Geosystems erlaubt wurden, kann das Recht des Anwenders einschränken, das Gerät in Betrieb zu nehmen.

Beschilderung

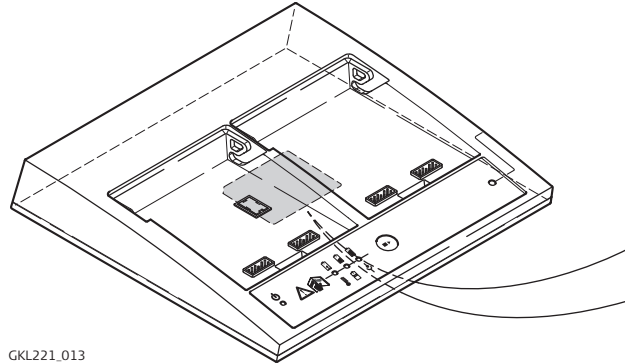

GKL221_013

Type: GKL221 **Art.No.:**

.....

.....

.....

.....

.....

.....

This device complies with part 15 of the FCC Rules. Operation is subject to the following two conditions: (1) This device may not cause harmful interference, and (2) this device must accept any interference received, including interference that may cause undesired operation.

Energieanschluss

- Netzanschluss, ~
- Gleichspannungsanschluss, ==

Eingangsspannung

- 100 - 240 VAC, 50/60 Hz
- 24VDC

Ladeleistung

maximal 18 VDC / maximal 4.0 A; abhängig vom Batterietyp

Entladeleistung

4 W

Nennleistung

~ : 75 W == : 55 W

Einsatzbereich

Nur zur Verwendung in trockenen Räumen, zum Beispiel Gebäuden, Kraftfahrzeugen
IP40, nach IEC60529

Temperaturbereich

Lagerung:	-40°C bis +70°C	-40°F bis +158°F
Betrieb:	~ : 0°C bis +40°C	+32°F bis 104°F
	== : 0°C bis +50°C	+32°F bis 122°F

Ladearten

Schnellladung wird durchgeführt für:

- Alle Leica Geosystems Batterien. Diese sind mit Temperaturüberwachung und Batterieerkennung ausgestattet. Ladestrom maximal 4.0 A, je nach Batterie.
- Alle Standard Camcorderbatterien mit drei Kontaktflächen und Temperaturüberwachung. Ladestrom maximal 1.6 A

Langsames Anladen wird durchgeführt für:

- NiCd und NiMH Batterien mit Temperatur kleiner +10°C.
- Li-Ion Batterien mit Temperatur kleiner +6°C
- Tief entladene oder leere Li-Ion, NiCd und NiMH Batterien.



Ladetechnologie

Erhaltungsladung wird durchgeführt für:

- NiCd und NiMH Batterien. Ladestrom abhängig von der Batterie. Die Ladung erfolgt reihum für circa fünfzehn Sekunden je Batterie.

Bei Li-Ion Batterien ist aufgrund der geringen Selbstentladung keine Erhaltungsladung notwendig.

Abschaltkriterien bei der Schnellladung:

Bei NiCd und NiMH Batterien:

Timer
 Kapazität
 Batterietemperatur
 Negative Spannungsdifferenz
 Temperaturanstieg pro Minute
 Mehrfachgradientenverfahren (Wendepunktverfahren)

Bei Li-Ion Batterien:

Timer
 Kapazität
 Batterietemperatur
 Ladestrom

Erhaltungsladung bei NiCd und NiMH Batterien:

Überwachung der Batteriespannung, des Ladestromes und der Batterietemperatur.

Zellarten

- NiCd
 - NiMH
 - Li-Ion
-

Lade- und Entladezeiten

Die Lade- und Entladezeiten hängen in erster Linie vom maximalen Lade- und Entladestrom, der Batteriekapazität und deren Ladezustand beim Einlegen ab.

Folgende Richtwerte sind gültig:

Schnellladung bei 20°C:

NiCd Batterien

bis 2200 mAh 1.0 bis 1.5 h

bis 7200 mAh 2.5 bis 4.0 h

NiMH Batterien

bis 2200 mAh 1.5 bis 2.0 h

bis 4900 mAh 2.0 bis 2.5 h

bis 10000 mAh 2.5 bis 5.5 h

Li-Ion Batterien

bis 4600 mAh 2.5 bis 3.5 h

Entladung:

für NiCd und NiMH Batterien

6V Batterien mit 600 mAh pro Stunde

12V Batterien mit 300 mAh pro Stunde

Li-Ion Batterien

7.4V Batterien mit 500 mAh pro Stunde

Anzeige

Siehe Kapitel "2.6 Leuchtanzeigen".

Gewicht

Ladestation, inklusive zwei Batterieadaptern: 1.12 kg

Aussenmasse

B X T X H: maximal 237 mm x 227 mm x 43 mm; inklusive Batterieadapter

Leica GKL221 Charger User Manual

EN

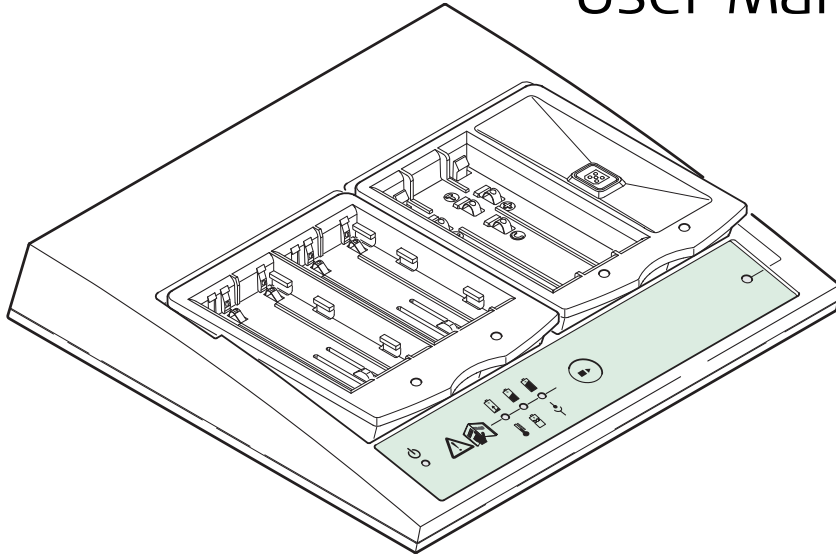

Version 1.3
English

- when it has to be **right**

Leica
Geosystems

Introduction



This manual contains important safety directions as well as instructions for setting up the product and operating it. Refer to "4 Safety Directions" for further information. Read carefully through this manual before switching on the product.

EN

Product identification

The model and the serial number of the product are indicated on the type plate. Enter the model and serial number in this manual and always refer to this information when contacting the agency or Leica Geosystems authorized service workshop.

Type: _____

Serial No.: _____

Symbols

The symbols used in this manual have the following meanings:





Type	Description
 Danger	Indicates an imminently hazardous situation which, if not avoided, will result in death or serious injury.
 Warning	Indicates a potentially hazardous situation or an unintended use which, if not avoided, could result in death or serious injury.
 Caution	Indicates a potentially hazardous situation or an unintended use which, if not avoided, may result in minor or moderate injury and/or appreciable material, financial and environmental damage.
	Important paragraphs which must be adhered to in practice as they enable the product to be used in a technically correct and efficient manner.

Table of Contents

In this manual	Chapter	Page
	1 System Description	4
	2 Operation	8
	2.1 Battery Adapter	8
	2.2 Connecting the Charger	9
	2.3 Inserting and Removing the Batteries	11
	2.4 Selection Button	14
	2.5 Charging the Battery	15
	2.6 Indicators	17
	2.7 Tips	20
	3 Care and Transport	21
	3.1 Transport	21
	3.2 Storage	21
	3.3 Cleaning and Drying	21
	4 Safety Directions	22
	4.1 General	22
	4.2 Purpose	22
	4.3 Limits of Use	23
	4.4 Areas of Responsibilities	23
	4.5 Hazards of Use	24
	4.6 Electromagnetic Compatibility EMC	25
	4.7 FCC Statement, Applicable in U.S.	26
	5 Technical Data	28

Description

The Leica Geosystems GKL221 is an intelligent charger with advanced charging technology. It is designed to charge all Leica batteries. As power supply, the mains as well as GDC221 vehicle adapter connected to the cigarette lighter socket of a vehicle can be used. The GKL221 is a very useful complement to all of your battery operated Leica Geosystems products.

General information

Up to five batteries can be connected to the charger. Two batteries can be charged at the same time. With more than two batteries connected, the rest are charged in the order they were connected. Beside charging, the charger can also discharge and refresh batteries.



We recommend starting up the product at this point, while continuing to read the Operating Instructions.

System components

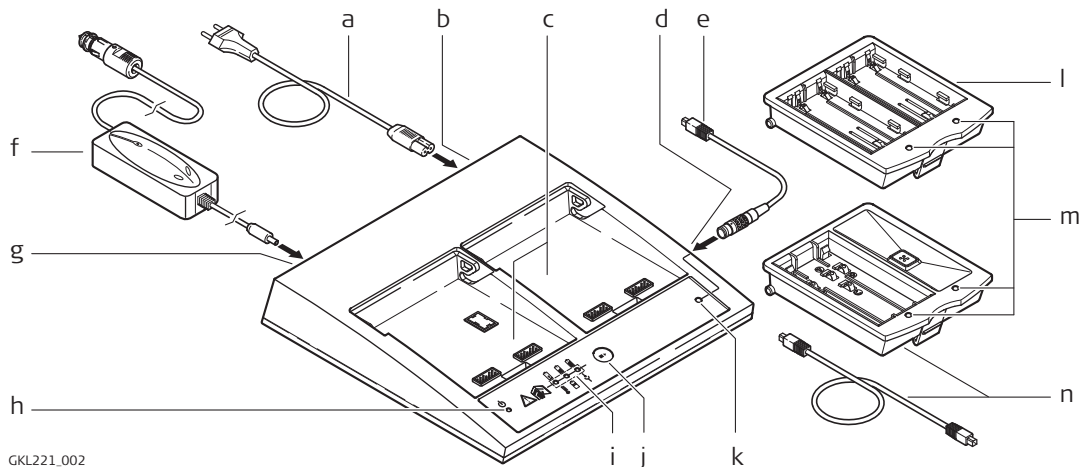

GKL221_002

- a) Mains cable, specific for relevant country
- b) Mains cable socket on the charger
- c) Adapter bays I and II for the GDI221 / GDI222 battery adapters
- d) External battery cable connection
- e) Cable socket for external 5 pole batteries
- f) Vehicle adapter GDC221, optional
- g) Vehicle cable socket on the charger
- h) Function indicator
- i) Capacity and error indicators
- j) Selection button
- k) Status indicator for external battery connection
- l) GDI221 battery adapter, optional
- m) Battery status indicators
- n) GDI222 battery adapter and 5 pole charging cable, optional

Rechargeable batteries

The following Leica Geosystems batteries can be charged:

GEB90
GEB211
GEB212
GEB221
GEB222
GEB241
GEB242



GEB111
GEB121

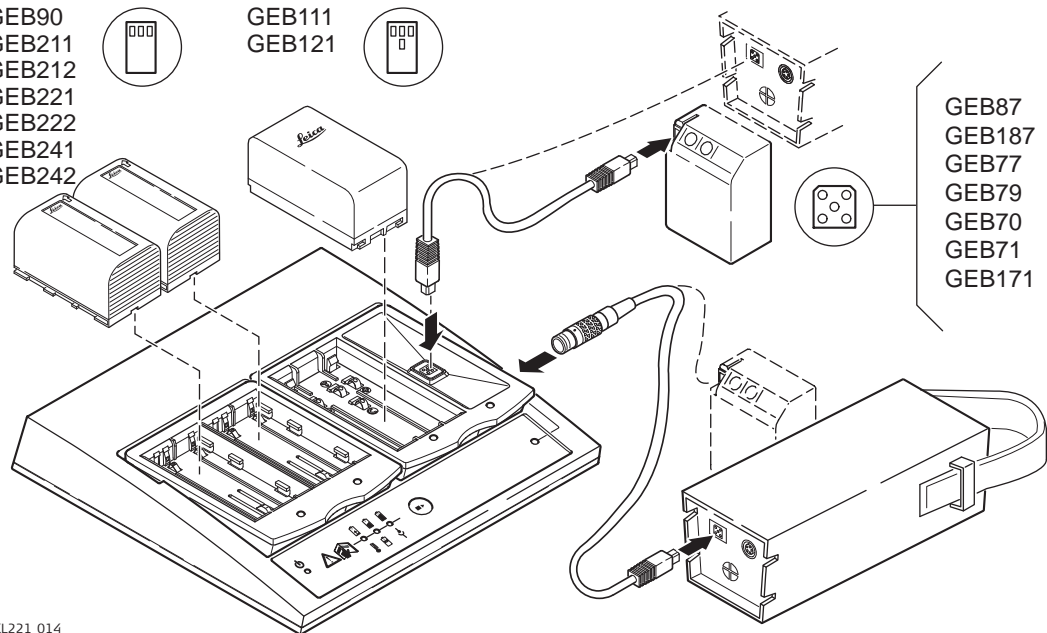

GKL221_014



The charger is designed to recharge and discharge original Leica batteries as well as some NiMH/NiCd camcorder batteries. Refer to section "2.3 Inserting and Removing the Batteries" for more information.

Charger and battery adapters

Using the charger in combination with the battery adapters, enables the following batteries to be connected to the charger:

Charger / battery adapter	Rechargeable batteries
GKL221 with two GDI221	Up to four Li-Ion batteries and one battery with a 5 pole socket.
GKL221 with one GDI221 and one GDI222	Up to two Li-Ion batteries, one camcorder type battery and two batteries with 5 pole sockets.
GKL221 with two GDI222	Up to two camcorder type batteries and three batteries with 5 pole sockets.

EN

2

2.1

Operation

Battery Adapter

Purpose

The battery adapter connects the charger to the corresponding batteries and has one LED per charging bay that indicates the status of the battery.

Type

The following battery adapters are available:

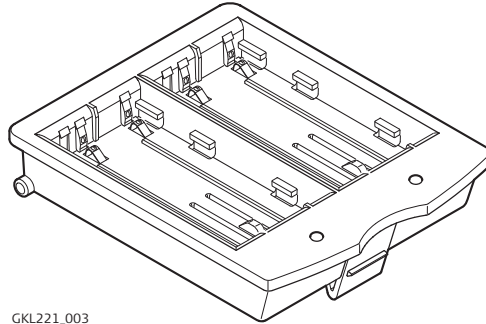

GKL221_003

GDI221

- For two Leica Geosystems Li-Ion batteries GEB90, GEB211, GEB212, GEB221, GEB222, GEB241 or GEB242.

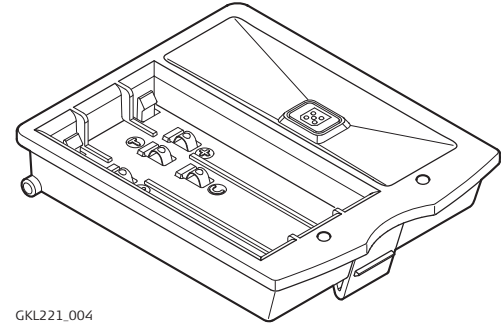

GKL221_004

GDI222

- For one Leica Geosystems NiMH battery GEB111 or GEB121 and one NiCd or NiMH 5 pole battery.

Inserting and removing

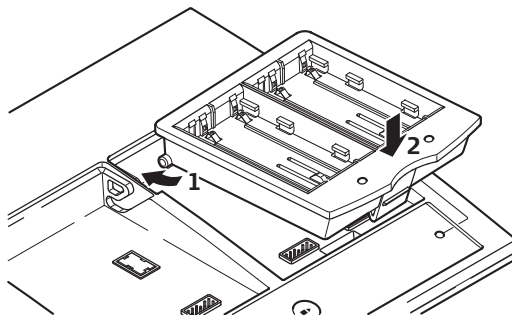

GKL221_005

Inserting

1. Insert the battery adapter along the rear guiding edge.
2. Press on the front of the battery adapter until it clicks and locks into place.

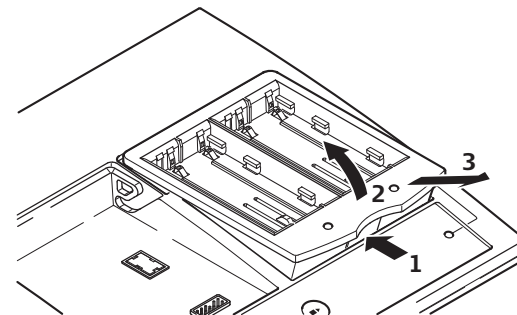

GKL221_006

Removing

1. Press on the front edge of the battery adapter to open it.
2. Carefully lift it up to the stop point.
3. Remove the adapter by pulling it out forwards.

EN

2.2

Connecting the Charger

Warning

Start up

Only use the charger in dry rooms! Never use the charger when it is wet or damp!

Always set the charger on a firm surface before starting it up.

Connect the charger either:

- With the supplied mains cable to the mains power socket or
- With the optional GDC211 vehicle adapter to the battery circuit of a vehicle



Pull the plug from the mains socket and from the vehicle's power socket, if the charger will not be used for a long period.



Only use the vehicle adapter for power supply from a vehicle. If the power supply comes from other sources, such as transformers, malfunctions could occur. Refer to section "5 Technical Data" for information on voltage and rated power.



Check older vehicles and makes sure that the + pole is on the middle contact surface of the cigarette lighter socket. Should the polarity be wrong, then the fuse in the charger or the fuse in the vehicle adapter has to be changed. The fuse in the charger has to be changed by an authorised Leica Geosystems service workshop. The fuse in the vehicle adapter has to be changed as described in the manual of the adapter.

Function check

After the adapter is connected to the mains or to the vehicle's battery circuit, the red, yellow and green function indicators light up once, the capacity and error indicators light up red and green. This is a function check.

If no battery was inserted, then only the green function indicator will light up.

If the status indicator and the three capacity and error indicators light up and remain red, then a defect was detected. Refer to section "2.6 Indicators" for additional information.

2.3

Inserting and Removing the Batteries

Li-Ion batteries

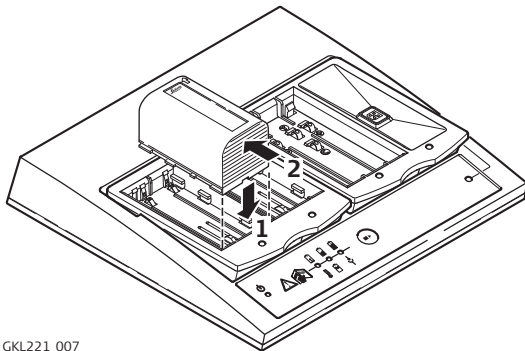

GKL221_007

Inserting:

1. Insert the battery flush to the front edge of the GDI221 battery bay.
2. Push the battery downwards with only slight pressure to the stop position.

Removing:

- Push the battery backwards to the stop and then remove it.

Warning

Only charge or discharge batteries recommended by Leica Geosystems. Only use Leica Geosystems Li-Ion batteries.

NiCd and NiMH batteries

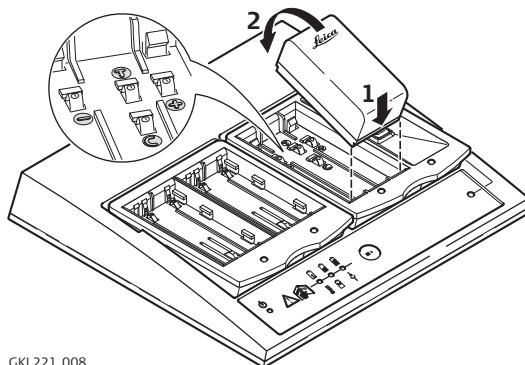

GKL221_008

Inserting:

1. Insert the battery into the front edge of the GDI222 battery bay.
2. Press it downwards until it clicks into place.

Removing:

- Pull up the back of the battery and remove it.



The Leica Geosystems GEB111 and GEB121 batteries have four contact surfaces, whereas camcorder batteries made by third parties only have three. The charger can distinguish between these two types of batteries and adjust the charging process accordingly.



Camcorder batteries with three contact surfaces must meet the following specifications to prevent damage:

- Voltage: 6 V
- Type of battery: NiCd or NiMH
- Minimum capacity: NiCd 1500 mAh, NiMH 1800 mAh
- Compatible contacts in the correct sequence, i.e. "+, T, -" in one line.

Camcorder batteries that meet these specifications are monitored for temperature and charged with a current of 1.6 A.

Batteries with 5 pole charging sockets

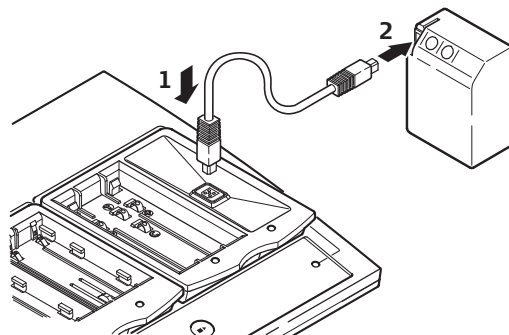

GKL221_009

Leica Geosystems batteries with 5 pole charging sockets, e.g. the GEB87 or GEB70, must be connected to the 5 pole charging socket of the charging cable.

EN

External batteries with 5 pole charging sockets

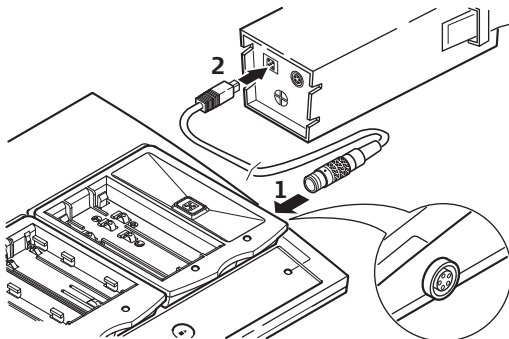

GKL221_010

Leica Geosystems batteries with 5 pole charging sockets, e.g. the GEB87 or GEB70, must be connected to the external battery connection socket of the charging cable.

☞ Batteries on external battery connection sockets can be charged without terminating a charging process that has already begun.

2.4

Selection Button

Functions

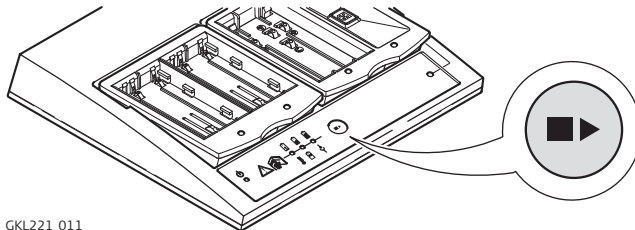

The selection button is used to select a charging bay and to toggle between the charging and discharging modes.

GKL221_011

Functions	Press the selection button	Description
Select the charging bay	Less than two seconds	The next bay containing a battery is selected. The selected bay is indicated by the yellow status indicator flashing quickly for about three seconds; the battery capacity is also displayed.
Switching between charging and discharging modes	More than three seconds	Switching to the discharging mode causes the status indicator to flash yellow-red for about five seconds, switching into charging mode causes it to flash yellow-green for about five seconds.



Discharging is indicated by the red status indicator flashing. When the process of discharging is completed, the green indicator starts to flash, indicating that the battery is now being charged.

2.5

Charging the Battery

Procedure

Step	Description
1.	Insert the battery adapter.
2.	Connect the charger to the power supply, the green function indicator lights up.
3.	Insert the battery. The yellow status indicator flashes to indicate that the battery has been recognized.
4.	Make sure the green status indicator remains on. The battery is now being charged. Refer to section "2.6 Indicators Lamps", if after connecting the battery a different status indicator lights up.  Check the status indicator after about one minute.
5.	The battery has been completely charged when the green status indicator starts to flash. Refer to section "5 Technical Data", for information on the charging times.
6.	The battery may be removed or remain connected to ensure it is fully charged when needed. Refer to section "Charging modes" for more information.

Set the charging sequence

The GKL221 charger can charge two batteries simultaneously.
When more than one battery is connected to the charger, the one connected first is charged first.
Always connect the more urgently needed battery first.

Priorities



Batteries are charged at the external battery connection without interrupting a charging process already begun.

Retaining the full charge

When the battery is fully charged, it may remain connected. NiCd and NiMH batteries are charged in turns to retain their full charge. In this way, the intrinsic self-discharging is compensated and the battery is always fully charged and ready for use. Refer to section "Charging modes" for more information.

Refreshing the battery



The refresh function totally discharges the battery and then puts it on quick charge.

Step	Description
1.	Connect the charger to the power supply.
2.	Insert the battery. The yellow status indicator flashes to indicate that the battery has been recognized.
3.	Press the selection button for more than three seconds to start the process of discharging the battery. Discharging is indicated by the red status indicator flashing.  Discharging may take a long time for large capacity batteries. To keep discharge times short, only use this function with batteries that are empty or low on charge.
4.	When the battery has been discharged, it is put on quick charge. The status indicator lights up green.
5.	The battery has been completely charged when the green status indicator starts to flash.
	We recommend refreshing NiCd and NiMH batteries two to three times when their capacity starts to sink noticeably.
	For Li-Ion batteries, a single discharging and charging cycle is sufficient. We recommend carrying out the process when the battery capacity indicated on the charger or on a Leica Geosystems product deviates significantly from the actual battery capacity available.



2.6

Indicators





Explanation of the symbols



Symbol	Meaning
	LED Off.
	LED on permanently.
	LED flashes.

Operation indicators

Symbol	LED	Meaning
	Off	The charger is not connected to the power supply.
	Green	The charger is connected to the power supply.

Status indicators

Symbol	LED	Meaning
	Off	The connected battery was not recognized.
	Yellow	The connected battery was recognized. The charger is in stand-by mode as two other batteries are being charged or discharged.
	Green	The connected battery is now being charged.
	Green	The connected battery is fully charged and can be removed.





Symbol	LED	Meaning
	Red	The charger has detected an error.
	Red	A battery to be refreshed is connected. The battery is being discharged.
	Yellow	Indicates the active, selected bay.

Capacity and error indicators

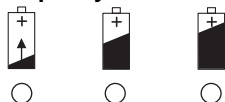
- In normal operation, the three capacity and error indicators light up green to indicate the capacity of the battery in the selected bay. After selecting the bay, the indicators light up for about ten to fifteen seconds, then they switch off.
- In case of an error, the capacity and error indicators turn red to show that there is an error in the selected bay.

Capacity indicators











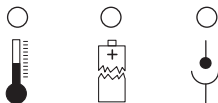



LEDs	Meaning
	The battery charge is less than 20%.
	The battery charge is at least 20%.
	The battery charge is at least 50%.
	The battery charge is at least 80%.



Presently, the level of charge can only be displayed for the Leica Geosystems GEB211, GEB212, GEB221, GEB222, GEB241, GEB242 and GEB90 batteries.

Error indicators



LEDs	Meaning	Measures to take
  	The battery is too cold or overheated.	Refer to section "Temperature range" for additional information.
  	The battery is defective.	Use a different battery.
  	Faulty contact on the battery or the battery adapter.	Check the contacts.
  	Hardware error in the charger.	Contact an authorised Leica Geosystems service workshop.



If the charger indicates an error when the battery is connected:

- Connect a different battery to check if the fault lies with the battery or the charger.
- If the problem persists, contact an authorised Leica Geosystems service workshop.



In case of error, please also check:

- If there is power coming from the mains or vehicle battery power circuit.
- If the cables are all correctly connected and no obvious faults can be detected.
- If the function indicator is lit on the optionally connected vehicle adapter.

2.7

Tips

Tips

- To charge batteries to their full capacity, new NiCd and NiMH batteries should be fully discharged and charged three to five times.
 - Let the batteries in the instrument discharge as much as possible. It prevents the so-called "memory effect" with NiCd batteries.
 - When using the vehicle adapter, always keep the motor running while charging the batteries.
-



Avoid sudden ambient temperature changes while charging the batteries (e.g. do not let the sun shine directly on the batteries or on the charger). Sudden ambient temperature changes may cause the charging process to end prematurely without having fully charged the batteries.

3

Care and Transport

3.1

Transport

Shipment

When transporting the product by rail, air or sea, always use the complete original Leica Geosystems packaging, transport container and cardboard box, or its equivalent, to protect against shock and vibration.

EN

3.2

Storage

Product

Respect the temperature limits when storing the product, particularly in summer if the product is inside a vehicle. Refer to section "5 Technical Data" for information about temperature limits.

3.3

Cleaning and Drying

Product

Use only a clean, soft, lint-free cloth for cleaning.

Cables and plugs

Keep plugs clean and dry. Blow away any dirt lodged in the plugs of the connecting cables.

4

4.1

Safety Directions

General

Description

The following instructions should enable the person responsible for the product and the person who actually uses the equipment to anticipate and avoid operational hazards

The person responsible for the product must ensure that all users understand these instructions and adhere to them.

4.2

Purpose

Permitted use

- Charging and discharging batteries of differing cell technologies.
-

Adverse use

- Use of the product without instruction.
- Use outside of the intended limits.
- Disabling safety systems.
- Removal of hazard notices.
- Opening the product using tools, for example screwdriver, unless this is specifically permitted for certain functions.
- Modification or conversion of the product.
- Use after misappropriation.
- Use of products with obviously recognizable damages or defects.
- Use with accessories from other manufacturers without the prior explicit approval of Leica Geosystems.

Warning

Adverse use can lead to injury, malfunction and damage. It is the task of the person responsible for the equipment to inform the user about hazards and how to counteract them. The product is not to be operated until the user has been instructed on how to work with it.

4.3

Limits of Use

Environment

Suitable for use in dry environment only and not under adverse conditions

4.4

Areas of Responsibilities

Manufacturer of the product

Leica Geosystems AG, CH-9435 Heerbrugg, hereinafter referred to as Leica Geosystems, is responsible for supplying the product, including the user manual and original accessories, in a completely safe condition.

Manufacturers of non Leica Geosystems accessories

The manufacturers of non-Leica Geosystems accessories are responsible for developing, implementing and communicating safety concepts for their products, and are also responsible for the effectiveness of those safety concepts in combination with the Leica Geosystems product.

Person in charge of the product

The person in charge of the product has the following duties:

- To understand the safety instructions on the product and the instructions in the user manual
 - To be familiar with local regulations relating to safety and accident prevention.
 - To inform Leica Geosystems immediately if the product becomes unsafe.
-

Warning

The person responsible for the product must ensure that it is used in accordance with the instructions. This person is also accountable for the training and the deployment of personnel who use the product and for the safety of the equipment in use.

4.5

Hazards of Use

Warning

The absence of instruction, or the inadequate imparting of instruction, can lead to incorrect or adverse use, and can give rise to accidents with far-reaching human, material, financial and environmental consequences

Precautions:

All users must follow the safety directions given by the manufacturer and the directions of the person responsible for the product.

Warning

The product is not designed for use under wet and severe conditions. If unit becomes wet it may cause you to receive an electric shock.

Precautions:

Use the product only in dry environments, for example in buildings or vehicles. Protect the product against humidity. If the product becomes humid, it must not be used!

Warning

If you open the product, either of the following actions may cause you to receive an electric shock.

- Touching live components
- Using the product after incorrect attempts were made to carry out repairs.

Precautions:

Do not open the product. Only Leica Geosystems authorized service workshops are entitled to repair these products.

Warning

Batteries not recommended by Leica Geosystems may be damaged if charged or discharged. They may burn and explode.

Precautions:

Only charge and discharge batteries recommended by Leica Geosystems.

Warning

If the product is improperly disposed of, the following can happen:

- If polymer parts are burnt, poisonous gases are produced which may impair health.
- If batteries are damaged or are heated strongly, they can explode and cause poisoning, burning, corrosion or environmental contamination.
- By disposing of the equipment irresponsibly you may enable unauthorized persons to use it in contravention of the regulations, exposing themselves and third parties to the risk of severe injury and rendering the environment liable to contamination.

Precautions:



The product must not be disposed with household waste.

Dispose of the product appropriately in accordance with the national regulations in force in your country.

Always prevent access to the product by unauthorized personnel.

Product specific treatment and waste management information can be downloaded from the Leica Geosystems home page at <http://www.leica-geosystems.com/treatment> or received from your Leica Geosystems dealer.

4.6

Electromagnetic Compatibility EMC

Description

The term Electromagnetic Compatibility is taken to mean the capability of the product to function smoothly in an environment where electromagnetic radiation and electrostatic discharges are present, and without causing electromagnetic disturbances to other equipment.

Warning

Electromagnetic radiation can cause disturbances in other equipment

Although the product meets the strict regulations and standards which are in force in this respect, Leica Geosystems cannot completely exclude the possibility that other equipment may be disturbed.

Caution

May cause failure in other equipment if the product is used with third party components, e.g. third party cables or external batteries.

Precautions:

Only use equipment or accessories recommended by Leica Geosystems. When combined with the product, they meet the strict requirements stipulated by the guidelines and standards.

Warning

If the product is operated with connecting cables attached at only one of their two ends, for example external supply cables, interface cables, the permitted level of electromagnetic radiation may be exceeded and the correct functioning of other products may be impaired.

Precautions:

While the product is in use, connecting cables, for example product to external battery, product to computer, must be connected at both ends.

4.7

FCC Statement, Applicable in U.S.

Warning

This product has been tested and found to comply with the limits for a Class B digital device, pursuant to part 15 of the FCC Rules.

These limits are designed to provide reasonable protection against harmful interference in a residential installation.

This equipment generates, uses and can radiate frequency energy and, if not installed and used in accordance with the instructions, may cause harmful interference to radio communications. However, there is no guarantee that interference will not occur in a particular installation.

If this equipment does cause harmful interference to radio or television reception, which can be determined by turning the equipment off and on, the user is encouraged to try to eliminate the interference by one or more of the following measures:

- Reorient or relocate the receiving antenna
- Increase the separation between the equipment and the receiver

- Connect the equipment to an outlet on a circuit different from that to which the receiver is connected.
- Consult the dealer or an experienced radio/TV technician for help.

Warning

Changes or modifications not expressly approved by Leica Geosystems for compliance could void the user's authority to operate the equipment.

Labels

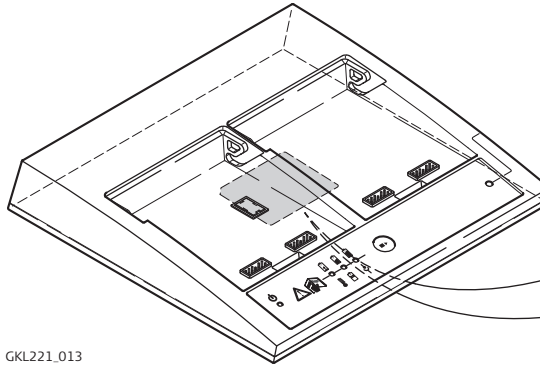

GKL221_013

Type: GKL221	Art.No.:
.....
.....
.....
.....
.....
.....
<p><i>This device complies with part 15 of the FCC Rules. Operation is subject to the following two conditions: (1) This device may not cause harmful interference, and (2) this device must accept any interference received, including interference that may cause undesired operation.</i></p>	

Power supply	<ul style="list-style-type: none"> • Mains connection, ~ • D/C voltage connection, == 									
Input voltage	<ul style="list-style-type: none"> • 100 - 240 VAC, 50/60 Hz • 24VDC 									
Charging power	Maximum 18 VDC / maximum 4.0 A; depends on the type of battery									
Discharging	4 W									
Power rating	~ : 75 W == : 55 W									
Operating environment	Only operate in dry environments, e.g. in buildings and vehicles IP40, according to IEC60529									
Temperature range	<table border="0"> <tr> <td>Storage:</td> <td>-40°C to +70°C</td> <td>-40°F to +158°F</td> </tr> <tr> <td>Operating:</td> <td>~ : 0°C to +40°C</td> <td>+32°F to 104°F</td> </tr> <tr> <td></td> <td>== : 0°C to +50°C</td> <td>+32°F to 122°F</td> </tr> </table>	Storage:	-40°C to +70°C	-40°F to +158°F	Operating:	~ : 0°C to +40°C	+32°F to 104°F		== : 0°C to +50°C	+32°F to 122°F
Storage:	-40°C to +70°C	-40°F to +158°F								
Operating:	~ : 0°C to +40°C	+32°F to 104°F								
	== : 0°C to +50°C	+32°F to 122°F								
Charging modes	<p>Quick charging mode for:</p> <ul style="list-style-type: none"> • All Leica Geosystems batteries. It features temperature monitoring and battery recognition. Charging current is maximum 4.0 A, depending on the battery. • All standard camcorder batteries with three contact surfaces and temperature monitoring. Charging current maximum 1.6 A <p>Normal charging mode for:</p> <ul style="list-style-type: none"> • NiCd and NiMH batteries with temperature below +10°C. • Li-Ion batteries with temperature below +6°C • Almost or totally empty Li-Ion, NiCd and NiMH batteries. 									



Charging technology

Conservation charging mode for:

- NiCd and NiMH batteries. Charging current depends on the type of battery. Charging is done in turns of about fifteen seconds per battery.

Li-Ion batteries do not require conservation charging, as they do not lose their charge when not used.

Switch off conditions in the quick charging mode:

For NiCd and NiMH batteries:

Timer
Capacity
Battery temperature
Negative voltage difference
Temperature increase per minute
Double inflection method

For Li-Ion batteries:

Timer
Capacity
Battery temperature
Charging current

Conservation charging of NiCd and NiMH batteries:

Monitors battery voltage, charging current and battery temperature.

Cell type

- NiCd
 - NiMH
 - Li-Ion
-

Recharging and discharging times

Recharging and discharging times depend primarily on the charging and discharging current, the capacity of the battery and the state of charge it is in when connected.

The following guidelines can be given:

Quick charging at 20°C:

NiCd batteries

max 2200 mAh 1.0 to 1.5 h

max 7200 mAh 2.5 to 4.0 h

NiMH batteries

max 2200 mAh 1.5 to 2.0 h

max 4900 mAh 2.0 to 2.5 h

max 10000 mAh 2.5 to 5.5 h

Li-Ion batteries

max 4600 mAh 2.5 to 3.5 h

Discharging:

For NiCd and NiMH batteries

6V batteries with 600 mAh per hour

12V batteries with 300 mAh per hour

Li-Ion batteries

7.4V batteries with 500 mAh per hour

Indication

Refer to section "2.6 Indicators".

Weight

Charger including two battery adapters: 1.12 kg

Dimensions

W X D X H: maximum 237 mm x 227 mm x 43 mm; including the battery adapter

Leica Chargeur GKL221

Mode d'emploi

FR

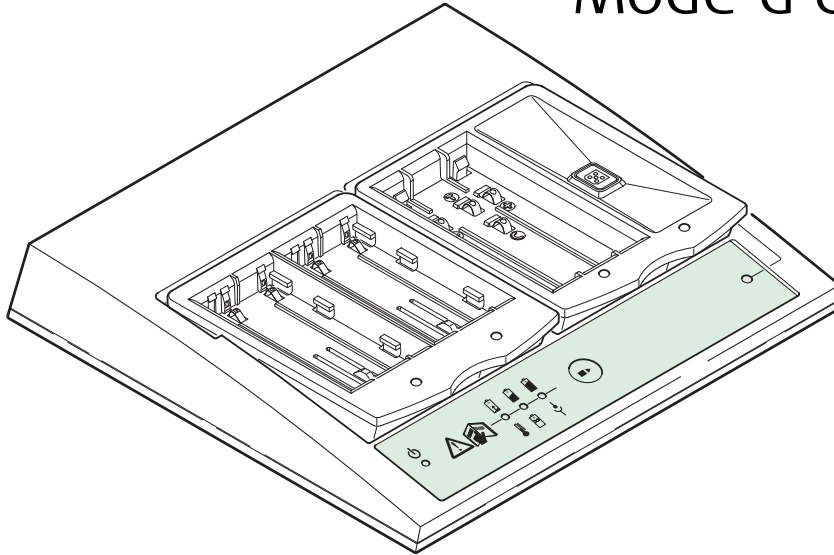

Version 1.3
Français

- when it has to be **right**

Leica
Geosystems

Introduction



Ce manuel renferme des instructions concernant la mise en oeuvre et l'utilisation de l'équipement, ainsi que des consignes de sécurité importantes. Voir chapitre "4 Consignes de sécurité" pour plus d'informations. Veuillez lire attentivement le mode d'emploi avant d'utiliser l'équipement.

FR

Identification





Le type et le numéro de série de l'équipement se trouvent sur la plaque signalétique. Veuillez inscrire ces données dans le mode d'emploi et toujours les indiquer comme référence lorsque vous vous adressez à votre point de vente ou à un point de service après-vente agréé par Leica Geosystems.

Type: _____

N° de série: _____

Symboles utilisés

Les symboles utilisés dans ce manuel ont la signification suivante:

Type	Description
 Danger	Danger directement lié à l'utilisation qui entraîne obligatoirement des dommages corporels importants ou la mort.
 Attention	Danger lié à l'utilisation ou à l'utilisation non conforme pouvant entraîner des dommages corporels importants ou la mort.
 Prudence	Danger lié à l'utilisation ou à une utilisation non conforme à la destination qui ne peut entraîner que de faibles dommages corporels, mais des dommages matériels, financiers ou écologiques considérables.
	Information utile qui aide l'utilisateur à utiliser le produit de manière techniquement correcte et efficace.

Sommaire

Contenu	Thème	Page
	1 Description système	4
	2 Utilisation	8
	2.1 Adaptateur de batterie	8
	2.2 Branchement du chargeur	9
	2.3 Mise en place des batteries	11
	2.4 Sélecteur	14
	2.5 Charger la batterie	15
	2.6 Indicateurs lumineux	17
	2.7 Conseils	20
	3 Entretien et transport	21
	3.1 Transport	21
	3.2 Stockage	21
	3.3 Nettoyage et séchage	21
	4 Consignes de sécurité	22
	4.1 Généralités	22
	4.2 Domaine d'application	22
	4.3 Limites d'application	23
	4.4 Responsabilités	23
	4.5 Dangers d'utilisation	24
	4.6 Compatibilité Electromagnétique EMC	26
	4.7 FCC statement, applicable aux USA	27
	5 Caractéristiques techniques	28

FR

1

Description système

Description

Le GKL221 de Leica Geosystems est un chargeur intelligent à technologie de charge avancée. Il se prête à la charge de toutes les batteries Leica Geosystems raccordées au secteur ou, par l'intermédiaire de l'adaptateur auto GDC221, au circuit de bord d'un véhicule. Le chargeur constitue un complément optimal de l'équipement Leica alimenté par batterie.

FR

Informations générales

Il est possible de raccorder jusqu'à cinq batteries au chargeur.

Deux batteries peuvent être chargées simultanément. Les batteries sont chargées dans l'ordre de connexion.

A côté de la charge, le chargeur contient des fonctions de décharge, de charge de maintien et de rafraîchissement de batteries.



Il est recommandé de mettre l'équipement en service pendant la lecture de ce manuel.

Composantes système

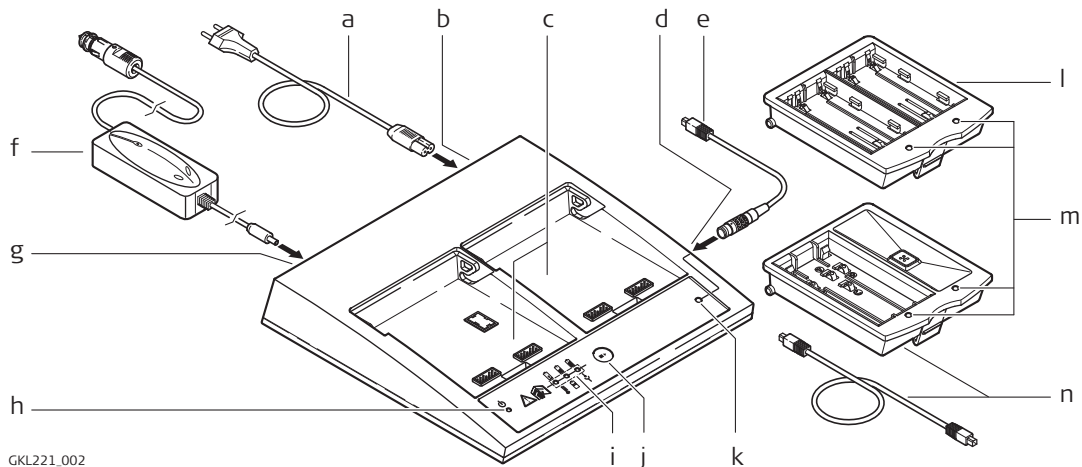

GKL221_002

- a) Câble secteur spécifique au pays
- b) Prise pour câble secteur
- c) Emplacements I et II pour adaptateurs de batterie GDI221 / GDI222
- d) Prise de batterie externe
- e) Câble de charge pour batterie 5 pôles externe
- f) Adaptateur auto GDC221, option
- g) Prise pour adaptateur auto
- h) Indicateur de fonctionnement
- i) Indicateurs de capacité et de défaut
- j) Sélecteur
- k) Indicateur d'état pour connexion de batterie externe
- l) Adaptateur de batterie GDI221, option
- m) Indicateurs d'état des batteries
- n) Adaptateur de batterie GDI222 et câble de charge 5 pôles adéquat, option

Batteries rechargeables

Les batteries Leica Geosystems suivantes peuvent être rechargées:

GEB90
GEB211
GEB212
GEB221
GEB222
GEB241
GEB242



GEB111
GEB121

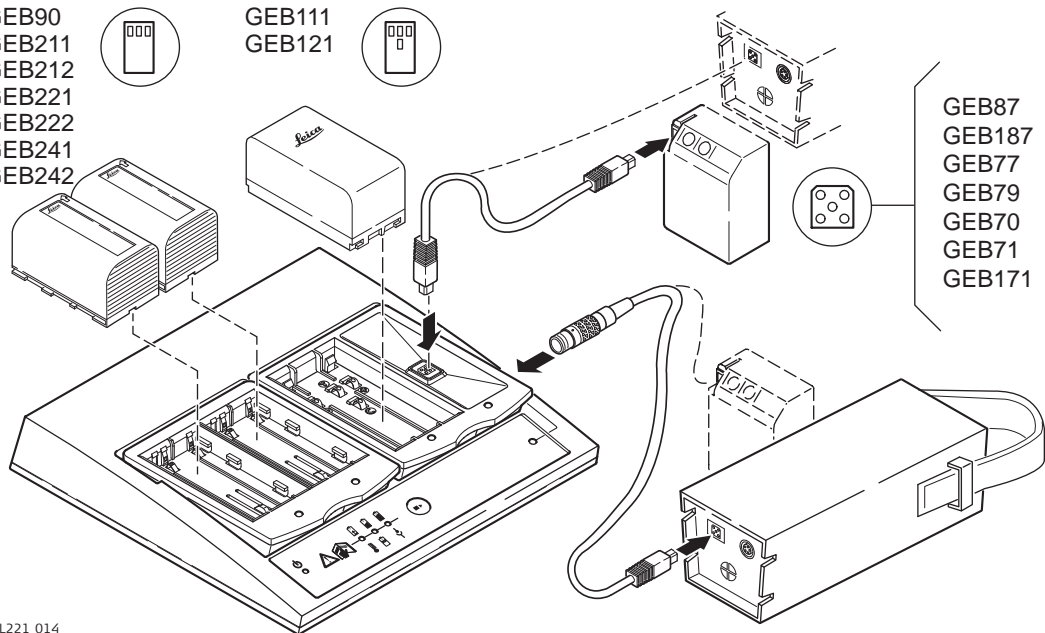

GEB87
GEB187
GEB77
GEB79
GEB70
GEB71
GEB171

GKL221_014



Le chargeur est seulement conçu pour la charge et la décharge de batteries Leica Geosystems d'origine ainsi que de diverses batteries de caméscope NiMH/NiCd courantes. Voir chapitre "2.3 Mise en place des batteries" pour plus d'informations.

Chargeur et adaptateur de batterie

Les combinaisons possibles du chargeur et des adaptateurs de batterie permettent la connexion et la charge des batteries suivantes:

Chargeur / adaptateur de batterie	Batteries rechargeables
GKL221 avec deux GDI221	Jusqu'à quatre batteries li-ion et une batterie à prise de charge 5 pôles.
GKL221 avec un GDI221 et un GDI222	Jusqu'à deux batteries li-ion, une batterie au format caméscope et deux batteries à prise de charge 5 pôles.
GKL221 avec deux GDI222	Jusqu'à deux batteries au format caméscope et trois batteries à prise de charge 5 pôles.

FR

2

2.1

Utilisation

Adaptateur de batterie

Objet

Les adaptateurs de batterie servent par exemple à relier le chargeur aux batteries correspondantes et renferment par emplacement de charge une LED pour l'indication de l'état de la batterie.

FR

Types

Les adaptateurs de batterie suivants sont disponibles :

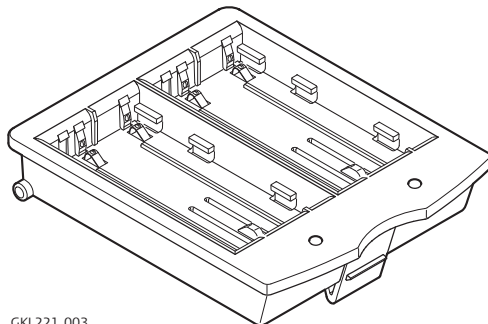

GKL221_003

GDI221

- Pour deux batteries Li-ion Leica Geosystems GEB90, GEB211, GEB212, GEB221, GEB222, GEB241 ou GEB242.

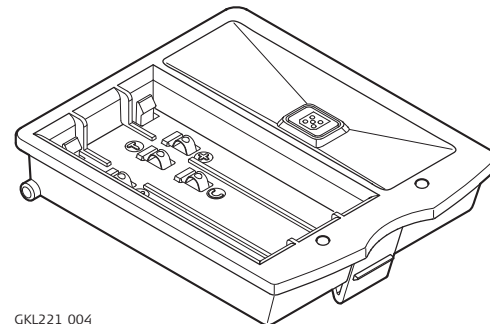

GKL221_004

GDI222

- Pour une batterie Leica Geosystems NiMH GEB111 ou GEB121 et une batterie NiCd ou NiMH 5 pôles.

Introduire, retirer

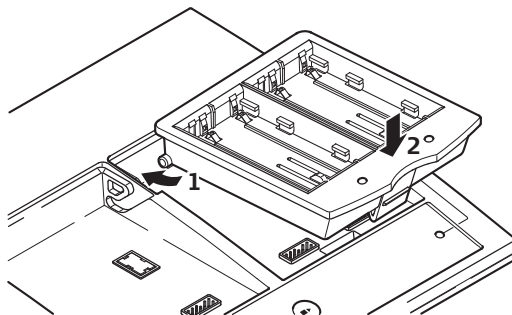

GKL221_005

Introduire

1. Introduire l'adaptateur de batterie avec le guidage arrière.
2. L'encliqueter par pression sur la partie avant. L'enclenchement est audible et palpable.

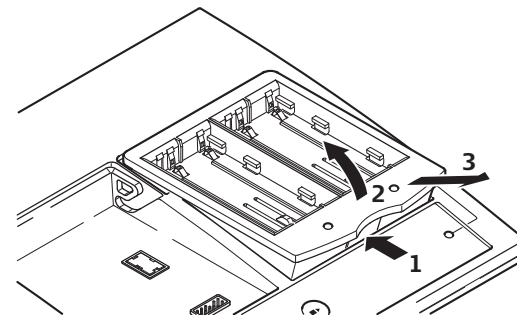

GKL221_006

Retirer

1. Déverrouiller l'adaptateur de batterie par pression de la languette avant.
2. Tirer légèrement vers le haut jusqu'en butée.
3. Retirer l'adaptateur par l'avant.

2.2

Branchement du chargeur



Attention

N'utilisez le chargeur qu'en intérieur, dans un endroit sec! Ne mettez jamais d'appareil humide sous tension!

Mise en service

Assurez-vous que l'appareil est bien stable avant de le mettre sous tension.

Reliez le chargeur:

- soit par le câble d'alimentation fourni au secteur
- soit au moyen de l'adaptateur auto GDC211 optionnel au circuit de bord du véhicule.



Pendant une coupure de courant et en cas de non-utilisation du chargeur pendant une durée prolongée, déconnectez le câble secteur ou l'adaptateur auto.



Alimentation du chargeur avec l'adaptateur auto seulement via les circuits de bord de véhicules. En cas d'alimentation par d'autres réseaux, par exemple des blocs secteurs à limitation de courant, des dysfonctionnements peuvent se présenter. Voir chapitre "5 Caractéristiques techniques" pour des informations sur la tension d'entrée et la puissance nominale.



Veillez sur les véhicules plus anciens à la bonne polarité du connecteur allume-cigares, le pôle + doit se trouver sur le contact du milieu. En cas de polarité incorrecte, le fusible du chargeur ou le fusible de l'adaptateur auto doit être remplacé. Le fusible du chargeur doit être remplacé par un point de service après-vente Leica Geosystems autorisé. Le remplacement du fusible dans l'adaptateur auto doit s'effectuer conformément au mode d'emploi de l'adaptateur auto.

Contrôle de fonctionnement

Après la connexion au secteur ou au circuit de bord du véhicule, les indicateurs d'état de l'adaptateur de batterie émettent une fois une lumière rouge, jaune et verte, les indicateurs de capacité et de défaut une lumière rouge et verte. Ceci permet de contrôler le fonctionnement.

Si aucune batterie n'est raccordée, seul l'indicateur de fonctionnement émet une lumière verte ensuite. Si les indicateurs d'état et les trois indicateurs de capacité et d'erreur émettent une lumière rouge permanente, l'appareil a détecté un défaut. Voir chapitre "2.6 Indicateurs lumineux" pour plus d'informations.

2.3

Mise en place des batteries

Batteries li-ion

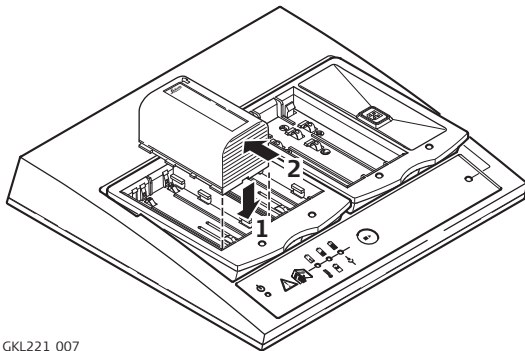

GKL221_007

Introduire:

1. Insérer la batterie en l'alignant sur le bord avant du logement GDI221.
2. Avancer la batterie avec une légère pression vers le bas jusqu'en butée.

Retirer:

- Repousser la batterie jusqu'en butée et la retirer.

Attention

Chargez ou déchargez avec le chargeur seulement des batteries recommandées par Leica Geosystems. Utilisez exclusivement des batteries li-ion de Leica Geosystems.

Batteries NiCd et NiMH

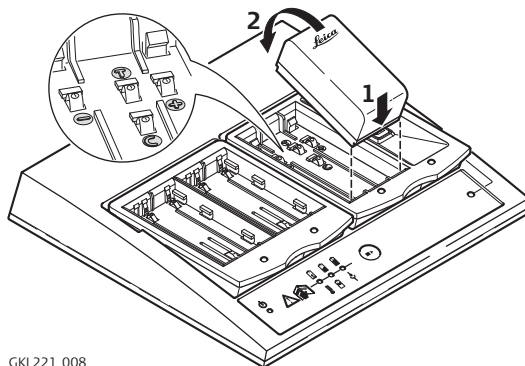

GKL221_008

Introduire:

1. Appuyer la batterie contre le bord avant de l'emplacement GDI222.
2. La presser vers le bas jusqu'à ce qu'un enclenchement net soit audible et palpable.

Retirer:

- Tirer la batterie du côté arrière vers le haut et l'enlever.



Les batteries Leica Geosystems GEB111 et GEB121 ont quatre surfaces de contact, les batteries de caméscope d'autres fabricants seulement trois. Le chargeur peut différencier ces types et adapter le mode de charge.



Les batteries de caméscope à trois surfaces de contact doivent remplir les conditions suivantes pour prévenir des endommagements:

- Tension: 6 V
- Type de cellule: NiCd ou NiMH
- Capacité minimum: NiCd 1500 mAh, NiMH 1800 mAh
- Contacts compatibles dans le bon ordre, "+, T, -" sur une rangée

Les batteries de caméscope qui répondent à ces exigences sont chargées avec un courant de 1,6 A à surveillance de température.

Batteries avec prise de charge 5 pôles

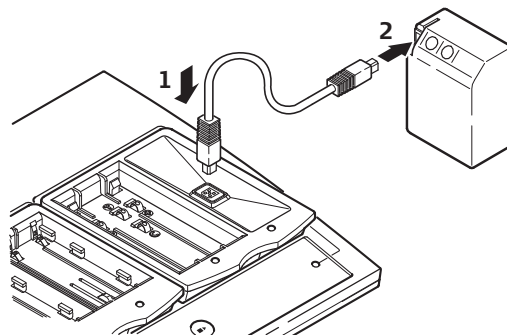

GKL221_009

Les batteries Leica Geosystems à prise de charge 5 pôles, par exemple GEB87 ou GEB70, sont raccordées au moyen du câble de charge à la prise 5 pôles.

FR

Batteries externes avec prise de charge 5 pôles

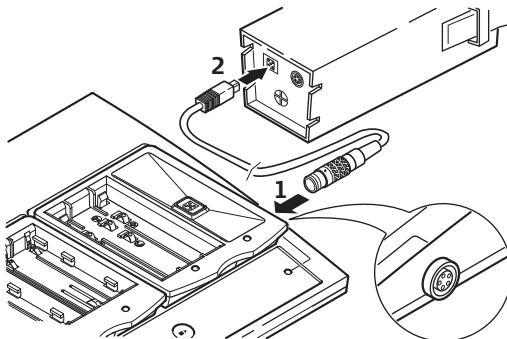

GKL221_010

Les batteries Leica Geosystems à prise de charge 5 pôles, par exemple GEB87 ou GEB70, sont raccordées au moyen du câble de charge à la prise externe.

☞ Les batteries raccordées à la prise externe sont chargées de façon privilégiée sans interrompre une charge en cours.

2.4

Sélecteur

Fonction

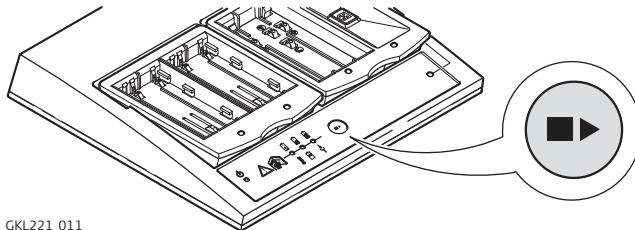

Le sélecteur sert à choisir un emplacement de charge et à commuter entre charge et décharge.

GKL221_011

Fonction	Presser le sélecteur	Description
Sélectionner l'emplacement de charge	moins de deux secondes	Le prochain emplacement équipé d'une batterie sera sélectionné. L'emplacement choisi est signalé par un clignotement jaune rapide de l'indicateur pendant environ trois secondes. Par ailleurs la capacité de la batterie s'affiche.
Commuter entre charge et décharge	plus de trois secondes	En cas de commutation sur le mode de décharge, l'indicateur d'état jaune-rouge clignote, en cas de commutation sur le mode de charge l'indicateur jaune-vert, respectivement pendant environ cinq secondes.



Une décharge est indiquée par un clignotement rouge de l'indicateur d'état. Une fois la décharge achevée, l'indicateur d'état redevient vert: la batterie est chargée.

2.5

Charger la batterie

Procédure

Etape	Description
1.	Insérer l'adaptateur de batterie.
2.	Raccorder le chargeur à l'alimentation: l'indicateur de fonctionnement émet une lumière verte.
3.	Introduire la batterie. L'indicateur d'état émet une lumière clignotante jaune: la batterie est détectée.
4.	S'assurer que l'indicateur d'état émet une lumière verte continue. La batterie est maintenant chargée. Voir chapitre "2.6 Indicateurs lumineux" si un autre indicateur d'état apparaît après le raccordement de la batterie.  Revérifier l'indicateur d'état au bout d'une minute environ.
5.	La batterie est entièrement chargée quand l'indicateur d'état émet une lumière verte clignotante. Voir chapitre "5 Caractéristiques techniques" pour plus d'informations sur les temps de charge.
6.	La batterie peut être retirée ou rester connectée afin qu'elle soit disponible chargée en cas de besoin. Voir chapitre "Types de charge" pour plus d'informations.

Déterminer l'ordre de charge

Le chargeur GKL221 peut charger deux batteries en même temps.
En cas de connexion de plus d'une batterie au chargeur, les batteries sont chargées dans l'ordre de connexion. Aussi, il convient de raccorder d'abord les batteries dont la charge est la plus urgente.

Priorité



La prise externe permet d'effectuer une charge privilégiée sans interrompre une charge en cours.

Charge de maintien

Si les batteries qui ont été connectées sont entièrement chargées, elles peuvent rester connectées.
Une charge de maintien séquentielle est effectuée pour les batteries NiCd et NiMH. Ainsi, l'auto-décharge due à des raisons techniques est compensée et les batteries sont toujours disponibles pour une utilisation à pleine capacité. Voir chapitre "Types de charge" pour plus d'informations.

Rafraîchissement de la batterie



La fonction de rafraîchissement consiste en une décharge complète suivie d'une charge rapide.

Etape	Description
1.	Raccorder le chargeur à l'alimentation.
2.	Introduire la batterie. L'indicateur d'état émet une lumière clignotante jaune: la batterie est détectée.
3.	Presser plus de trois secondes sur le sélecteur: la décharge de la batterie sélectionnée commence. La décharge est indiquée par un clignotement rouge de l'indicateur d'état.  La décharge de batteries plus grandes peut durer très longtemps. Pour diminuer les temps de décharge, cette fonction ne devrait s'effectuer que si les batteries sont vides ou presque vides!
4.	Si la décharge de la batterie est complète, une charge rapide s'enclenche. L'indicateur d'état émet alors une lumière verte.
5.	La batterie est entièrement chargée quand l'indicateur d'état émet une lumière verte clignotante.
	Nous recommandons de soumettre les batteries NiCd et NiMH deux ou trois fois à un cycle de rafraîchissement quand la capacité d'une batterie diminue sensiblement.
	Un cycle de décharge-charge unique s'avère suffisant pour les batteries li-ion. Nous recommandons de l'effectuer quand la capacité de batterie affichée sur le chargeur ou un produit de Leica Geosystems diverge fortement de la capacité réellement disponible.



2.6

Indicateurs lumineux





Explication des symboles



Symbole	Signification
	LED éteinte.
	LED lumineuse en permanence.
	LED clignotante.

Indicateur de fonctionnement

Symbole	LED	Signification
	Eteinte	Chargeur non raccordé à une source de courant.
	Verte	Chargeur raccordé à une source de courant.

Indicateurs d'état

Symbole	LED	Signification
	Eteinte	Pas de batterie détectée sur la prise.
	Jaune	Le chargeur a détecté une batterie sur la prise. Elle est en attente étant donné que deux autres batteries sont en train d'être chargées ou déchargées.
	Verte	La batterie raccordée est maintenant chargée.
	Verte	La batterie raccordée est maintenant chargée complètement et peut être retirée.





Symbole	LED	Signification
	Rouge	Le chargeur a détecté une erreur.
	Rouge	Batterie raccordée pour le rafraîchissement. Elle se trouve en phase de décharge.
	Jaune	Signalisation de l'emplacement actif sélectionné.

Indicateurs de capacité et de défaut

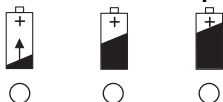
- En mode normal, les trois indicateurs de capacité et de défaut signalent en vert la capacité de la batterie dans l'emplacement sélectionné. L'affichage apparaît pendant dix à quinze secondes après le choix d'un emplacement puis s'éteint.
- Dans le cas d'un défaut, les indicateurs de capacité et de défaut montrent le code de défaut pour l'emplacement sélectionné en rouge.

Indicateurs de capacité











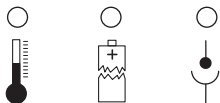



LED	Signification
	Etat de charge de la batterie inférieure à 20%.
	Etat de charge de la batterie au moins égale à 20%.
	Etat de charge de la batterie au moins égale à 50%.
	Etat de charge de la batterie au moins égale à 80%.



L'indication de la capacité est pour l'instant seulement possible pour les batteries Leica Geosystems GEB211, GEB212, GEB221, GEB222, GEB241, GEB242, GEB90.

Indications de défaut



LED	Signification	Mesures
  	Température de batterie trop basse ou trop haute.	Voir chapitre " Plage de température" pour plus d'informations.
  	Batterie défectueuse.	Utiliser une autre batterie.
  	Contact défectueux sur la batterie ou l'adaptateur de batterie.	Vérifier les contacts.
  	Erreur de matériel chargeur.	Contactez un point de service après-vente Leica Geosystems autorisé.



Quand le chargeur signale un défaut en cas de batterie raccordée:

- Raccordez une autre batterie pour vérifier si le dysfonctionnement concerne la batterie ou le chargeur.
- Si le problème ne peut être éliminé, contactez un point de service après-vente Leica Geosystems autorisé.



En cas de dysfonctionnements, contrôlez aussi les points suivants:

- Y a-t-il une alimentation électrique par la prise de courant ou le circuit de bord du véhicule?
- Les câbles sont-ils enfilés correctement et dépourvus de vices apparents?
- En cas de raccordement de l'adaptateur auto optionnel:
L'indicateur de fonctionnement de l'adaptateur auto est-il allumé?

2.7

Conseils

FR



Conseils

- Pour exploiter pleinement leur capacité, il convient de soumettre les batteries NiCd et NiMH neuves à trois-cinq cycles de décharge-charge.
 - Décharger le plus possible les batteries dans l'instrument. Ceci évite l'effet mémoire sur les batteries NiCd.
 - En cas d'utilisation de l'adaptateur auto, les batteries devraient seulement être chargées quand le moteur tourne.
-

Évitez une augmentation rapide de la température ambiante pendant la charge, par exemple par rayonnement solaire sur les chargeurs et batteries. Une hausse rapide de la température peut provoquer une fin de charge prématurée à capacité batterie réduite.

3

Entretien et transport

3.1

Transport

Expédition

Utilisez l'emballage original de Leica Geosystems, le coffret de transport et le carton d'expédition ou équivalent pour tout transport par train, avion ou bateau. Il sera ainsi protégé des chocs et des vibrations.

3.2

Stockage

Produit

Respectez les valeurs limite de température en stockant l'équipement, particulièrement en été si l'équipement se trouve dans un véhicule. Voir chapitre "5 Caractéristiques techniques" pour plus d'informations sur la plage de température de stockage.

3.3

Nettoyage et séchage

Produit

Utilisez un chiffon propre et doux, sans peluche, pour le nettoyage.

Câbles et connecteurs

Les connecteurs doivent être propres et secs. Retirez en soufflant toutes les impuretés logées dans les connecteurs des câbles de liaison.

4

Consignes de sécurité

4.1

Généralités

Description

Ce chapitre est destiné aux propriétaires et utilisateurs de l'instrument d'utiliser l'équipement en prenant connaissance des dangers éventuels afin de les éviter.

Le propriétaire doit s'assurer que tous les utilisateurs comprennent et respectent les consignes qui suivent.

4.2

Domaine d'application

Utilisation conforme

- Charge et décharge de batteries à technologies cellulaires différentes.

Utilisation non conforme

- Utilisation de l'instrument sans instruction préalable.
- Utilisation hors des limites d'application.
- Désactivation des systèmes de sécurité.
- Suppression des panneaux d'avertissement.
- L'ouverture de l'instrument à l'aide d'outils, comme par exemple un tournevis est interdite sauf mention expresse pour certaines fonctions.
- Modification ou transformation de l'instrument.
- Utilisation de l'instrument après vol.
- Utilisation des produits présentant des défauts ou dégâts éminemment reconnaissables.
- Utilisation avec des accessoires issus d'autres fabricants sans l'autorisation expresse préalable de Leica Geosystems.



Attention

Une utilisation non conforme peut conduire à des blessures, dysfonctionnements et dégâts. C'est le rôle du propriétaire de l'équipement d'informer l'utilisateur sur les risques inhérents et les mesures préventives à prendre. L'utilisateur peut utiliser l'instrument s'il a été formé au préalable.

4.3

Limites d'application

Environnement

Uniquement utiliser le chargeur dans un intérieur sec et un milieu non hostile.

4.4

Responsabilités

Fabricant de l'instrument

Leica Geosystems AG, CH-9435 Heerbrugg, dénommé ci-après Leica Geosystems, est responsable de la livraison sûre et en très bon état de l'instrument, y compris le manuel d'utilisation et les accessoires d'origine.

Fabricants d'accessoires autres que Leica Geosystems

Les fabricants d'accessoires autres que Leica Geosystems pour l'instrument sont responsables pour l'élaboration, la mise en pratique et la diffusion de concepts de sécurité relatifs à leurs produits, ainsi que de l'efficacité de ces concepts avec l'instrument Leica Geosystems.

Propriétaire de l'instrument

Il incombe au propriétaire les charges suivantes :

- comprendre les consignes de sécurité de l'instrument et les instructions du manuel d'utilisation.
 - se familiariser avec la législation locale en matière de sécurité et prévention des accidents.
 - informer immédiatement Leica Geosystems si l'instrument et son application présentent des défauts de sécurité.
-

Attention

Le propriétaire doit s'assurer que l'instrument est utilisé conformément aux instructions. Cette personne est également responsable de la formation du personnel utilisant l'instrument et de la sécurité de l'équipement utilisé.

4.5

Dangers d'utilisation

Attention

L'absence d'instruction, ou une instruction incomplète, peut donner lieu à une manipulation incorrecte ou à une application non conforme des instruments. Il peut en résulter des accidents entraînant des dommages corporels, matériels, financiers et écologiques importants.

Precautions:

Tous les utilisateurs doivent suivre les consignes de sécurité indiquées par le fabricant et les directives du propriétaire de l'instrument.

Attention

L'équipement n'est pas conçu pour être utilisé dans un environnement humide et hostile. En cas d'infiltration d'eau, il y a danger d'électrocution.

Mesure préventive:

N'utilisez l'équipement qu'en intérieur, dans des endroits secs, par exemple dans un bâtiment ou un véhicule.

Protégez-le de l'humidité. Ne vous servez pas d'un équipement humide!

Attention

Si vous ouvrez l'équipement, vous vous exposez à un risque d'électrocution si:

- vous touchez des composants sous tension
- vous mettez l'équipement en service après avoir tenté d'effectuer une réparation d'une manière incorrecte.

Mesure préventive:

N'ouvrez pas l'équipement vous-même. Seul un technicien de maintenance agréé par Leica Geosystems est habilité à effectuer la réparation.

 **Attention**

En cas de charge ou de décharge de batteries non recommandées par Leica Geosystems, ces batteries peuvent être endommagées. Cette situation peut provoquer un incendie ou une explosion.

Mesure préventive:

Chargez ou déchargez avec le chargeur seulement des batteries recommandées par Leica Geosystems.

 **Attention**

Si la mise au rebut du produit ne s'effectue pas dans les règles, les conséquences suivantes peuvent s'ensuivre :

- La combustion d'éléments en polymère produit un dégagement de gaz toxiques nocifs pour la santé.
- Il existe un risque d'explosion des batteries si elles sont endommagées ou exposées à de fortes températures ; elles peuvent alors provoquer des brûlures, des intoxications, une corrosion ou libérer des substances polluantes.
- En vous débarrassant du produit de manière irresponsable, vous pouvez permettre à des personnes non habilitées de s'en servir en infraction avec les règlements en vigueur ; elles courent ainsi, de même que des tiers, le risque de se blesser gravement et exposent l'environnement à un danger de libération de substances polluantes.

Mesure préventive:



Ne vous débarrassez pas du produit en le jetant avec les ordures ménagères. Débarrassez-vous du produit de manière appropriée et dans le respect des règlements en vigueur dans votre pays. Veillez toujours à empêcher l'accès au produit à des personnes non habilitées.

Des informations spécifiques au produit (traitement, gestion des déchets) peuvent être téléchargées sur le site de Leica Geosystems à l'adresse <http://www.leicageosystems.com/treatment> ou obtenues auprès de votre représentant Leica Geosystems.

4.6

Compatibilité Electromagnétique EMC

Description

Le terme Compatibilité Electromagnétique désigne la capacité de l'instrument à fonctionner impeccablement dans un environnement où règnent des rayonnements électromagnétiques et des décharges électrostatiques, et ceci sans interférer électromagnétiquement avec d'autres instruments.

Attention

Un rayonnement électromagnétique peut interférer avec d'autres instruments.

Bien que l'instrument réponde rigoureusement aux normes et directives en vigueur, Leica Geosystems ne peut entièrement exclure la possibilité d'une éventuelle interférence avec d'autres instruments.

Prudence

Un risque d'interférence demeure avec l'utilisation d'accessoires fabriqués par des tiers, comme par exemple les ordinateurs de terrain, PC, les talkies-walkies, les câbles non standard ou les batteries externes.

Precautions:

Utilisez l'équipement et les accessoires conseillés par Leica Geosystems. Une fois combiné à l'instrument, ils répondent rigoureusement aux conditions mentionnées dans les directives et normes.

Attention

En cas de mise en oeuvre de l'instrument avec des câbles branchés d'un seul côté, par exemple des câbles d'alimentation externes, câbles d'interface, le niveau auto-risé de rayonnement électromagnétique risque d'être dépassé et le bon fonctionnement des autres instruments perturbé.

Precautions:

Lors de son utilisation, il faut toujours brancher les câbles des deux côtés, comme par exemple pour la batterie externe, l'instrument à l'ordinateur.

4.7

FCC statement, applicable aux USA

Attention

Cet équipement a été testé et ses limites sont conformes à celles décrites pour des dispositifs numériques de classe B, décrites dans le paragraphe 15 des règles FCC. Ces limites ont pour but de fournir une protection suffisante contre les interférences nocives dans une installation résidentielle.

Cet équipement génère, utilise et émet une énergie fréquence radio et, s'il n'est pas installé et utilisé conformément aux instructions, peut engendrer des perturbations dans la communication radio.

Cela ne garantit cependant pas une absence d'interférence dans certaines installations.

Si cet équipement engendre des interférences nocives dans la réception radio ou télévision, constatées en éteignant puis en rallumant l'équipement, l'utilisateur peut tenter de corriger ces interférences grâce aux mesures suivantes:

- Réorientez ou relocalisez l'antenne de réception.
- Augmentez la séparation entre l'équipement et le capteur.
- Augmentez la séparation entre l'équipement et le capteur.
- Consultez le revendeur ou un technicien expérimenté dans le domaine radio/TV.

Attention

Les changements ou modifications n'ayant pas été expressément approuvés par Leica Geosystems dans le cadre de la conformité peuvent limiter le droit de l'utilisateur d'utiliser l'équipement.

Etiquetage

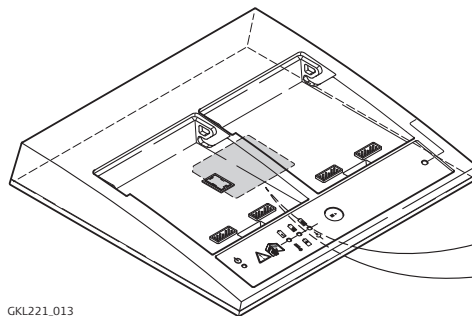

GKL221_013

Type: GKL221

Art.No.:

.....
.....
.....
.....
.....
.....
.....

This device complies with part 15 of the FCC Rules. Operation is subject to the following two conditions: (1) This device may not cause harmful interference, and (2) this device must accept any interference received, including interference that may cause undesired operation.

Connexion électrique	<ul style="list-style-type: none"> secteur, ~ courant continu, == 									
Tension d'entrée	<ul style="list-style-type: none"> 100 - 240 VAC, 50/60 Hz 24VDC 									
Puissance de charge	maximal 18 VDC / maximal 4.0 A; dépend du type de batterie									
Puissance de décharge	4 W									
Puissance nominale	~ : 75 W == : 55 W									
Environnement d'utilisation	Uniquement dans un intérieur sec, par exemple dans des bâtiments, véhicules IP40, selon IEC60529									
Plage de température	<table border="0"> <tr> <td>Stockage:</td> <td>-40°C à +70°C</td> <td>-40°F à +158°F</td> </tr> <tr> <td>Utilisation:</td> <td>~ : 0°C à +40°C</td> <td>+32°F à 104°F</td> </tr> <tr> <td></td> <td>== : 0°C à +50°C</td> <td>+32°F à 122°F</td> </tr> </table>	Stockage:	-40°C à +70°C	-40°F à +158°F	Utilisation:	~ : 0°C à +40°C	+32°F à 104°F		== : 0°C à +50°C	+32°F à 122°F
Stockage:	-40°C à +70°C	-40°F à +158°F								
Utilisation:	~ : 0°C à +40°C	+32°F à 104°F								
	== : 0°C à +50°C	+32°F à 122°F								
Types de charge	<p>Charge rapide exécutée pour:</p> <ul style="list-style-type: none"> Toutes les batteries Leica Geosystems. Celles-ci sont munies d'une surveillance de température et de détection de batterie. Courant de charge maximal 4.0 A par batterie. Toutes les batteries caméscope standard avec trois surfaces de contact et une surveillance de température. Courant de charge maximal 1.6 A <p>Charge lente exécutée pour:</p> <ul style="list-style-type: none"> Batteries NiCd et NiMH d'une température inférieure à +10°C. Batteries li-ion d'une température inférieure à +6°C Batteries li-ion, NiCd et NiMH à décharge importante. 									



Technologie de charge

Charge de maintien exécutée pour:

- Batteries NiCd et NiMH. Le courant de charge dépend de la batterie. La charge s'effectue pendant environ quinze secondes par batterie.

En raison de la faible auto-décharge, les batteries li-ion ne nécessitent pas de charge de maintien.

Critères d'arrêt de la charge rapide:

Sur batteries NiCd et NiMH:

Timer
Capacité
Température de batterie
Différence de tension négative
Hausse de température par minute
Procédé multigradient (point d'inversion)

Sur batteries li-ion:

Timer
Capacité
Température de batterie
Courant de charge

FR

Types de cellule

Charge de maintien sur batteries NiCd et NiMH:

Surveillance de la tension de la batterie, du courant de charge et de la température de la batterie.

- NiCd
 - NiMH
 - Li-ion
-

Temps de charge et de décharge

Les temps de charge et de décharge dépendent en premier lieu du courant de charge/décharge maximal, de la capacité batterie et de l'état de charge à l'insertion.

Les valeurs indicatives suivantes sont valables:

Charge rapide à 20°C:

Batteries NiCd

jusqu'à 2200 mAh 1.0 à 1.5 h
jusqu'à 7200 mAh 2.5 à 4.0 h

Batteries NiMH

jusqu'à 2200 mAh 1.5 à 2.0 h
jusqu'à 4900 mAh 2.0 à 2.5 h
jusqu'à 10000 mAh 2.5 à 5.5 h

Batteries li-ion

jusqu'à 4600 mAh 2.5 à 3.5 h

Décharge:

pour batteries NiCd et NiMH

Batteries 6 V avec 600 mAh par heure
Batteries 12 V avec 300 mAh par heure

Batteries li-ion

Batteries 7.4V avec 500 mAh par heure

Indicateurs

Voir chapitre "2.6 Indicateurs lumineux".

Poids

Chargeur avec deux adaptateurs de batterie: 1.12 kg

Dimensions extérieures

L X P X H: maximal 237 mm x 227 mm x 43 mm; avec adaptateur de batterie

Leica Cargador GKL221

Manual de Empleo

ES

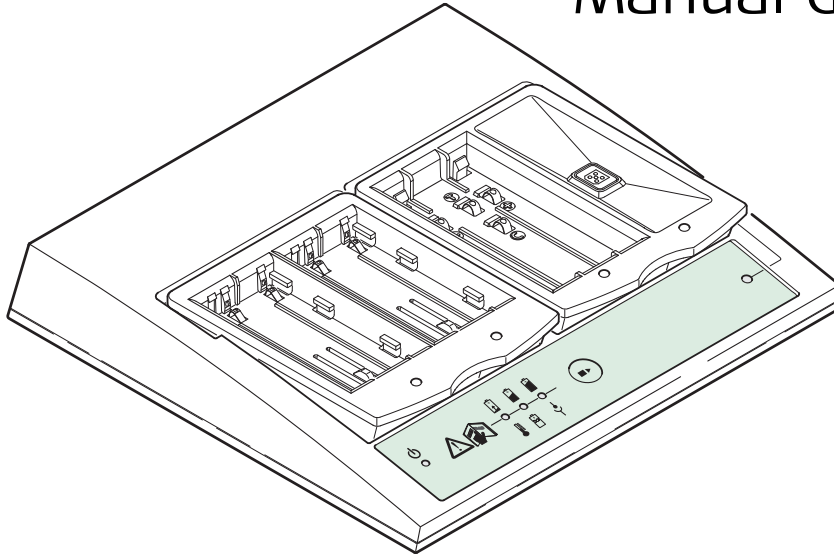

Versión 1.3
Español

- when it has to be **right**

Leica
Geosystems

Introducción



Este manual incluye, junto a las instrucciones relativas a su utilización, una serie de importantes normas de seguridad. Para mayor información, consulte la sección "4 Instrucciones de Seguridad" . Lea el manual atentamente antes de empezar a trabajar con el producto.

Identificación del producto





El tipo y el número de serie del producto figuran en la etiqueta situada en la parte posterior del mismo. Traspase estos datos a su manual y haga referencia a ellos cuando tenga que consultar con nuestra agencia o taller de servicio Leica Geosystems .

Modelo: _____

No. de serie.: _____

Símbolos utilizados

Los símbolos utilizados en este manual tienen el siguiente significado:

Símbolo	Significado
 Peligro	En estos casos existe riesgo de empleo que puede ocasionar daños personales graves o incluso la muerte.
 Aviso	En estos casos existe riesgo de empleo. Un empleo no conforme puede ocasionar daños personales graves o incluso la muerte.
 Cuidado	En estos casos existe riesgo de empleo. Un empleo no conforme puede ocasionar daños personales leves, pero importantes daños materiales, económicos o ecológicos.
	Información que ayuda al usuario a emplear el producto de modo eficiente y correcto.

Índice	Tema	Página
1	Descripción del sistema	4
2	Empleo	8
2.1	Adaptador para batería	8
2.2	Conectar el cargador	9
2.3	Insertar y retirar las baterías	11
2.4	Botón de selección	14
2.5	Carga de la batería	15
2.6	Indicadores	17
2.7	Consejos	20
3	Cuidado y transporte	21
3.1	Transporte	21
3.2	Almacenamiento	21
3.3	Limpieza y secado	21
4	Instrucciones de Seguridad	22
4.1	General	22
4.2	Utilización	22
4.3	Límites de empleo	23
4.4	Ámbitos de responsabilidad	23
4.5	Peligros durante el uso	24
4.6	Compatibilidad electromagnética EMC	25
4.7	Normativa FCC (aplicable en EE UU)	26
5	Datos técnicos	28

Descripción

El cargador GKL221 de Leica Geosystems es un cargador inteligente que utiliza una avanzada tecnología. Está diseñado para cargar todas las baterías Leica. Como fuente de alimentación, puede emplear la red eléctrica o el adaptador GDC221 para vehículo, el cual se conecta al mechero del mismo. El GKL221 es un complemento ideal para todos los productos Leica Geosystems que operan con baterías.

Información general

Al cargador se le pueden conectar hasta cinco baterías. Es posible cargar dos baterías al mismo tiempo. Si al cargador se conectan más de dos baterías, el resto se cargan en el orden con el que fueron conectadas.

Además de cargar, el cargador también puede descargar y actualizar baterías.



Se recomienda encender el producto en este punto, mientras continúa con la lectura de las Instrucciones de Empleo.

Componentes del sistema

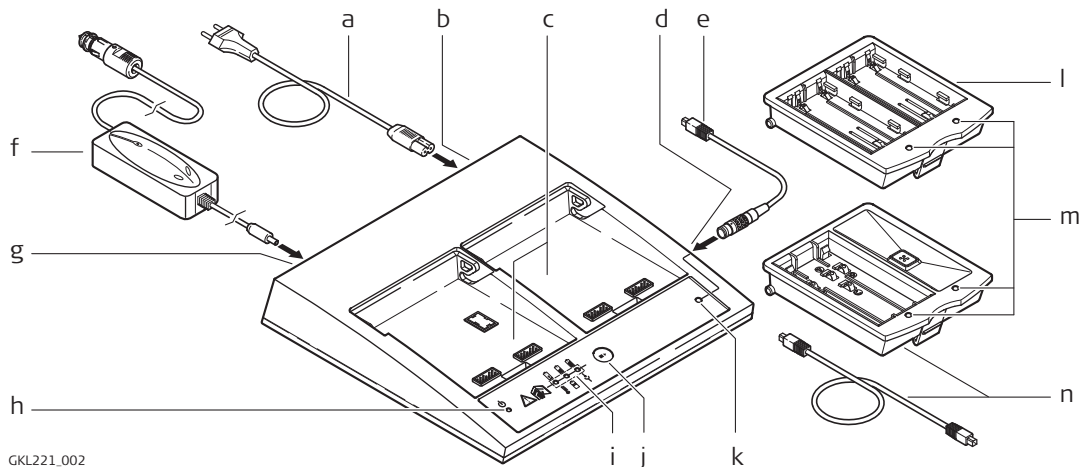

GKL221_002

- a) Cable para conexión a la red eléctrica, específico para cada país
- b) Contacto para cable de conexión a la red eléctrica
- c) Compartimentos I y II para adaptadores de baterías GDI221 / GDI222
- d) Cable de conexión para batería externa
- e) Contacto del cable para baterías externas de 5 polos
- f) Adaptador GDC221 para vehículo (opcional)
- g) Contacto para cable de conexión al vehículo
- h) Indicador de función
- i) Indicadores de capacidad y error
- j) Botón de selección
- k) Indicador de estado para conexión de batería externa
- l) Adaptador GDI221 para batería (opcional)
- m) Indicadores del estado de la batería
- n) Adaptador GDI222 para batería y cable para carga de 5 polos (opcional)

Baterías recargables

Se pueden cargar las siguientes baterías Leica Geosystems :

GEB90
GEB211
GEB212
GEB221
GEB222
GEB241
GEB242



GEB111
GEB121

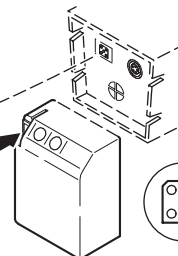
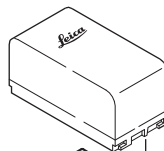
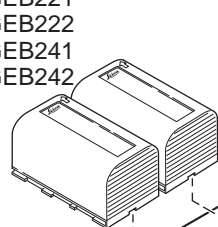

GEB87
GEB187
GEB77
GEB79
GEB70
GEB71
GEB171

GKL221_014



El cargador está diseñado para recargar y descargar baterías Leica originales, así como algunas baterías cámara de vídeo de NiMH/NiCd. Consulte la sección "2.3 Insertar y retirar las baterías" para mayor información.

Cargador y adaptadores para batería

Al utilizar el cargador en combinación con los adaptadores para batería, se pueden conectar al cargador las siguientes baterías:

Cargador / Adaptador para batería	Baterías recargables
GKL221 con dos GDI221	Hasta cuatro baterías de ion Li y una batería con un contacto de 5 polos.
GKL221 con una GDI221 y una GDI222	Hasta dos baterías de ion Li, una batería de tipo cámara de vídeo y dos baterías con contactos de 5 polos.
GKL221 con dos GDI222	Hasta dos baterías de tipo cámara de vídeo y tres baterías con contactos de 5 polos.

ES

2

2.1

Empleo

Adaptador para batería

Propósito

El adaptador para batería conecta el cargador a las baterías correspondientes y cuenta con un indicador luminoso LED para cada compartimento de carga, el cual indica el estado de la batería.

Tipo

Se encuentran disponibles los siguientes adaptadores para batería:

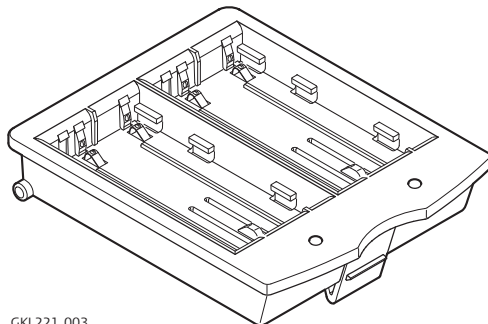

GKL221.003

GDI221

- Para dos baterías Leica Geosystems GEB90, GEB211, GEB212, GEB221, GEB222, GEB241 o GEB242 de ion Litio.

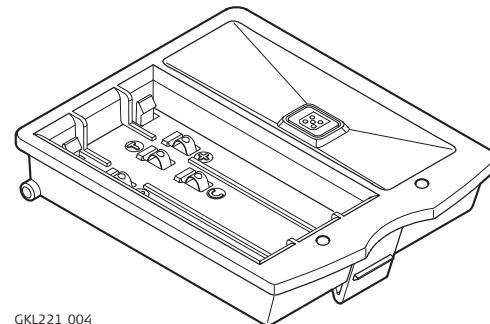

GKL221.004

GDI222

- Para una batería Leica Geosystems GEB111 o GEB121 de NiMH o una batería GEB121 y una batería de NiCd o NiMH de 5 polos.

Insertar y retirar

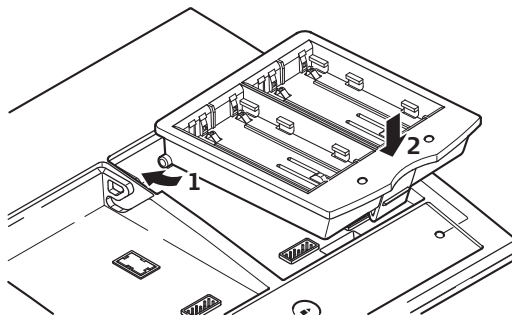

GKL221_005

Insertar

1. Inserte la batería a lo largo del borde de la parte posterior.
2. Presione sobre la parte delantera del adaptador para batería hasta escuchar un clic.

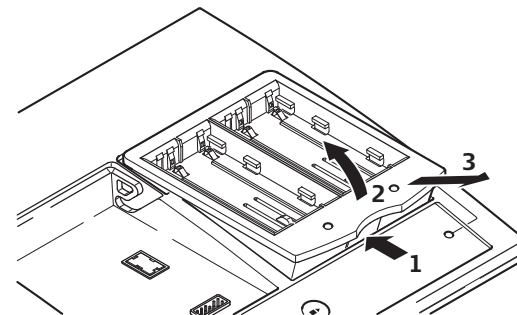

GKL221_006

Retirar

1. Presione sobre el borde delantero del adaptador para batería para abrirlo.
2. Levántelo cuidadosamente hasta el punto límite.
3. Retire el adaptador, sacándolo hacia afuera.

ES

2.2

Conectar el cargador



Aviso

¡Emplear el adaptador únicamente en recintos secos! ¡Nunca utilice el cargador si se encuentra húmedo o mojado!

Iniciar

Antes de poner a funcionar el cargador, asegúrese de que está situado en una superficie estable.

Conecte el cargador, ya sea:

- Mediante el cable de alimentación suministrado al cable de red, o
- Con el adaptador opcional GDC211 para vehículo



Para mayor seguridad, cuando el cargador no se va a utilizar durante un tiempo, hay que desenchufar tanto el cable de red como el cable de conexión al vehículo.



Alimentar el cargador en la conexión de vehículo sólo mediante la red de eléctrica del propio vehículo. La alimentación por otras fuentes (p.ej. unidades de alimentación con limitador de corriente) puede producir errores en el funcionamiento. Consulte la sección "5 Datos técnicos" para mayor información acerca de la tensión y alimentación nominal.



En vehículos antiguos hay que asegurarse de que la polaridad del enchufe del mechero es correcta (polo + en contacto central). En caso de polaridad incorrecta, deberá cambiarse el fusible del cargador o el fusible del adaptador para vehículo. El fusible del cargador deberá cambiarse en un taller de Servicio Técnico autorizado por Leica Geosystems. El fusible del adaptador para vehículo debe cambiarse como se describe en el manual del adaptador.

Revisión de funcionamiento

Después de conectar el adaptador al cable de red o al circuito de batería del vehículo, los indicadores luminosos rojo, amarillo y verde se encenderán una vez. Los indicadores de capacidad y error encenderán el rojo y verde. Esta es una revisión del funcionamiento.

Si no hay batería insertada, únicamente se encenderá el indicador de función verde.

En caso de encenderse el indicador de estado y los tres indicadores de capacidad y error, se habrá detectado un defecto. Para mayor información, consulte la sección "2.6 Indicadores" .

2.3

Insertar y retirar las baterías

Baterías de ion Li

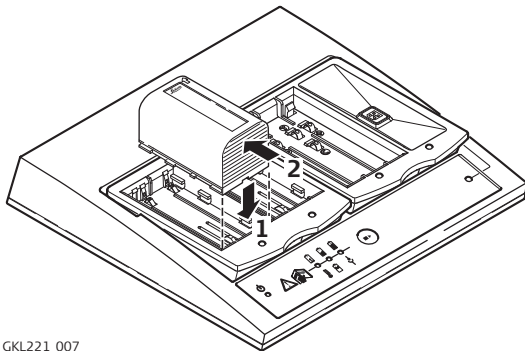

GKL221_007

Insertar:

1. Inserte la batería en el compartimento para baterías GDI221.
2. Empuje la batería hacia abajo con una ligera presión hasta el punto límite.

Retirar:

- Empuje la batería hacia adelante hasta el punto límite y retírela.



Solo cargue o descargue baterías recomendadas por Leica Geosystems. Utilice solo baterías Leica Geosystems de ion Li.

ES

Baterías de NiCd y NiMH

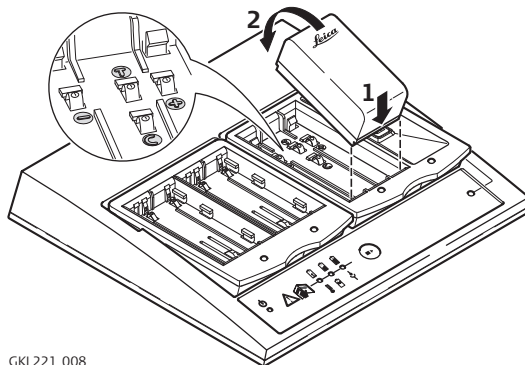

GKL221_008

Insertar:

1. Inserte la batería en el compartimento para baterías GDI222.
2. Empújela hacia abajo hasta escuchar un clic.

Retirar:

- Saque la parte posterior de la batería y retírela.



Las baterías Leica Geosystems GEB111 y GEB121 tienen cuatro superficies de contacto, mientras que las baterías de cámara de vídeo de otros fabricantes solo tienen tres. El cargador puede distinguir entre ambos tipos de baterías y ajustar el proceso de carga según sea el caso.



Las baterías de cámara de vídeo con tres superficies de contacto deben cumplir con las siguientes especificaciones para evitar daños:

- Voltaje: 6 V
- Tipo de batería: NiCd o NiMH
- Capacidad mínima: NiCd 1500 mAh, NiMH 1800 mAh
- Contactos compatibles en la secuencia correcta, es decir, "+, T, -" en una línea.

A las baterías de cámara de vídeo que cumplen con estas especificaciones se controla la temperatura y se cargan con una corriente de 1.6 A.

Baterías con enchufes para carga de 5 polos

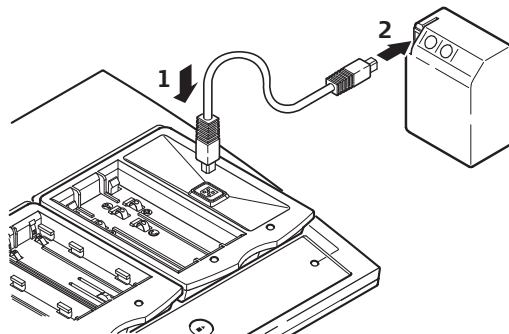

GKL221_009

Las baterías Leica Geosystems con enchufes para carga de 5 polos, por ejem., baterías GEB87 o GEB70, deben conectarse al contacto de 5 polos del cable para carga.

ES

Baterías externas con enchufes para carga de 5 polos:

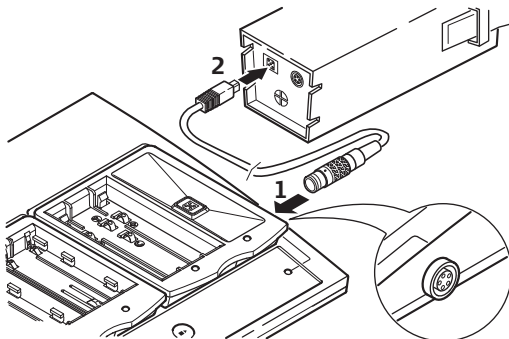

GKL221_010

Las baterías Leica Geosystems con enchufes para carga de 5 polos, por ejem., baterías GEB87 o GEB70, deben conectarse al contacto para baterías externas del cable para carga.

☞ Las baterías conectadas a los enchufes de baterías externas pueden cargarse sin necesidad de terminar un proceso de carga que ya haya comenzado.

2.4

Botón de selección

Funciones

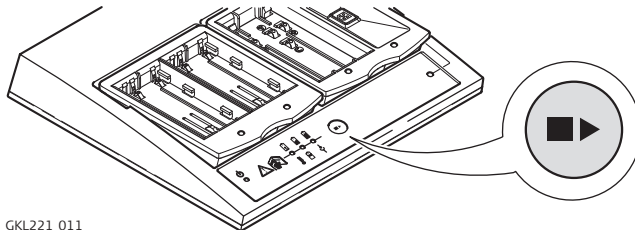

El botón de selección se emplea para elegir un compartimento de carga y para alternar entre los modos de carga y descarga.

GKL221_011

Funciones	Presione el botón de selección	Descripción
Seleccionar del compartimento de carga	Menos de dos segundos	Se elegirá el siguiente compartimento de carga que contenga una batería. El compartimento de carga se señala mediante el indicador de estado amarillo, el cual se encenderá rápidamente y de manera intermitente durante aprox. tres segundos; también se mostrará la capacidad de la batería.
Alternar entre los modos de Carga y Descarga	Más de tres segundos	Al cambiar al modo de descarga, el indicador de estado se enciende de manera intermitente y pasa del amarillo al rojo durante aprox. cinco segundos, al cambiar al modo de carga el indicador de estado se enciende de manera intermitente y pasa del amarillo al verde durante aprox. cinco segundos.



La descarga se señala con el indicador de estado rojo encendido de manera intermitente. Cuando el proceso de descarga finaliza, el indicador verde comienza a parpadear, indicando que la batería ya está cargada.

2.5

Carga de la batería

Procedimiento

Paso	Descripción
1.	Inserte el adaptador para batería.
2.	Conecte el cargador a la fuente de alimentación, se encenderá el indicador de función verde.
3.	Inserte la batería. El indicador de estado amarillo comienza a parpadear para señalar que la batería ha sido reconocida.
4.	Comprobar que el indicador de estado verde continúa encendido. En ese caso, la batería se está cargando. Consulte la sección "2.6 Indicadores luminosos", si después de conectar la batería se enciende un indicador de estado diferente.  Revise el indicador de estado después de aprox. un minuto.
5.	La batería se habrá cargado por completo cuando el indicador de estado muestre una luz verde intermitente. Consulte la sección "5 Datos técnicos", para obtener información acerca de los tiempos de carga.
6.	Ya se puede retirar la batería del cargador para utilizarla o dejarla conectada para asegurar que tiene carga completa cuando sea necesaria. Consulte la sección "Modos de carga" para mayor información.

Establecer el orden de carga

El cargador GKL221 puede cargar dos baterías simultáneamente. Si al cargador se conectan varias baterías, se van cargando en el orden en que han sido conectadas. Por esa razón, enchufe primero la batería que más necesite, para que tenga prioridad.

Prioridades



Las baterías conectadas al contacto para baterías externas se cargan sin interrumpir un proceso de carga que ya haya iniciado.

Conservar la carga completa

Cuando la batería tiene carga completa, puede continuar conectada. Las baterías de NiCd y NiMH se cargan por turnos para conservar su carga completa. De esta forma, la descarga automática intrínseca se compensa y la batería siempre tendrá carga completa y estará lista para emplearse. Para mayor información consulte la sección "Modos de carga".

Actualización de la batería



La función de actualización efectúa una descarga completa de la batería e inicia un ciclo de carga rápida.

Paso	Descripción
1.	Conecte el cargador a la fuente de alimentación.
2.	Inserte la batería. El indicador de estado amarillo comienza a parpadear para señalar que la batería ha sido reconocida.
3.	Presione el botón de selección durante más de tres segundos para iniciar el proceso de descarga de la batería. La descarga se señala con el indicador de estado rojo encendido de manera intermitente.  La descarga puede tardar un tiempo considerable para baterías de capacidad considerable. Para reducir los tiempos de descarga, utilice esta función únicamente con baterías completamente descargadas o con poca carga.
4.	Cuando la batería ha sido descargada, comienza un ciclo de carga rápida. Se encenderá el indicador de estado verde.
5.	La batería se habrá cargado por completo cuando el indicador de estado muestre una luz verde intermitente.
	Se recomienda actualizar las baterías de NiCd y NiMH de dos a tres veces cuando su capacidad de carga comience a disminuir considerablemente.
	Para baterías de ion Li, es suficiente un solo ciclo de carga y descarga. Se recomienda efectuar el proceso cuando la capacidad de la batería indicada en el cargador, o en uno de los productos de Leica Geosystems, difiera significativamente de la capacidad total de la batería.



2.6

Indicadores





Explicación de los símbolos

Símbolo	Significado
	Indicador apagado.
	Indicador encendido continuamente.
	Indicador intermitente.



Indicadores de operación

Símbolo	Indicador	Significado
	Apagado	El cargador no está conectado a la fuente de alimentación.
	Verde	El cargador está conectado a la fuente de alimentación.

Indicadores de estado

Símbolo	Indicador	Significado
	Apagado	La batería conectada no fue reconocida.
	Amarillo	La batería conectada fue reconocida. El cargador se encuentra en estado de espera porque hay otras dos baterías cargándose o descargándose.
	Verde	La batería conectada se está cargando.
	Verde	La batería conectada ya está cargada y se puede retirar.





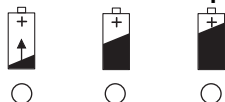

Indicadores de capacidad y error

Símbolo	Indicador	Significado
	Rojo	El cargador ha detectado un error.
	Rojo	Se encuentra conectada una batería para ser actualizada. La batería se está descargando.
	Amarillo	Indica el compartimento activo y seleccionado.

- Durante la operación normal, los tres indicadores de capacidad y error muestran una luz verde para indicar la capacidad de la batería que se encuentra en el compartimento seleccionado. Después de seleccionar el compartimento, los indicadores se encienden durante aprox. quince segundos y después se apagan.
- En caso de error, los indicadores de capacidad y error muestran una luz roja para señalar que existe un error en el compartimento seleccionado.

Indicadores de capacidad









Indicadores	Significado
○ ○ ○	La batería tiene menos del 20% de carga.
 ○ ○	La batería tiene por lo menos un 20% de carga.
  ○	La batería tiene por lo menos un 50% de carga.
  	La batería tiene por lo menos un 80% de carga.

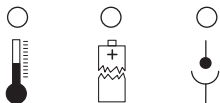

El nivel de carga se puede mostrar únicamente para las baterías GEB211, GEB212, GEB221, GEB222, GEB241, GEB242 y GEB90 de Leica Geosystems.

Indicadores de error



Indicadores	Significado	Medidas a tomar
 ○ ○	La batería está demasiado fría o sobrecalentada.	Para mayor información, Consulte la sección "Rango de temperaturas" .
○  ○	La batería está defectuosa.	Utilice una batería diferente.
○ ○ 	Falla en el contacto de la batería o en el adaptador para batería.	Revise los contactos.
  	Error de hardware en el cargador.	Póngase en contacto con un taller de servicio autorizado por Leica Geosystems .

ES



Si el cargador indica un error cuando la batería se encuentra conectada:

- Conecte una batería diferente para revisar si el fallo se encuentra en la batería o en el cargador.
- Si no puede solventar el problema, póngase en contacto con un taller de servicio autorizado por Leica Geosystems.



En caso de error, revise también:

- ¿Llega corriente a la toma de red o a la red eléctrica del vehículo?
- ¿Los cables se encuentran conectados correctamente y no hay fallos evidentes?
- ¿El indicador de función se encuentra encendido en el adaptador opcional conectado para vehículo?

2.7

Consejos

Consejos

- Para cargar las baterías a su capacidad máxima, las baterías nuevas de NiCd y NiMH deben descargarse por completo y cargarse de tres a cinco veces.
 - Descargar al máximo posible las baterías en el instrumento. De esta forma se evita el llamado "efecto de memoria" en las baterías de NiCd.
 - Para cargar las baterías en un vehículo, el motor ha de estar siempre en marcha.
-



Evitar los cambios bruscos de la temperatura ambiental durante la carga (por ejemplo, por radiación solar) en los cargadores y las baterías. Dichos cambios bruscos de temperatura pueden hacer que el proceso de carga termine antes de tiempo y no se cargue la batería en toda su capacidad.

3

Cuidado y transporte

3.1

Transporte

Envío

Para transportar el producto en tren, avión o barco utilizar siempre el embalaje original de Leica Geosystems completo (maletín de transporte y caja de cartón) u otro embalaje adecuado, para proteger el instrumento frente a golpes y vibraciones.

3.2

Almacenamiento

Producto

Observar los valores límite de temperatura para el almacenamiento del equipo, especialmente en verano si se transporta dentro de un vehículo. Consulte la sección "5 Datos técnicos" para mayor información acerca de los límites de temperatura.

3.3

Limpieza y secado

Producto

Limpie el producto siempre con un paño seco y limpio.

Cables y enchufes

Mantener los enchufes limpios y secos. Limpiar soplando cualquier suciedad depositada en los enchufes de los cables de conexión.

4

Instrucciones de Seguridad

4.1

General

Descripción

Con estas instrucciones se trata de que el encargado del producto y la persona que lo está utilizando estén en condiciones de detectar a tiempo eventuales riesgos que se producen durante el uso, es decir, que a ser posible los eviten.

La persona responsable del producto deberá cerciorarse de que todos los usuarios entienden y cumplen estas instrucciones.

4.2

Utilización

Uso procedente

- Cargar y descargar baterías de diferentes tecnologías de celda.

Uso impropio

- Utilización del producto sin instrucción.
- Uso fuera de los límites de aplicación.
- Anulación de los dispositivos de seguridad.
- Retirada de los rótulos de advertencia.
- Abrir el producto utilizando herramientas (p.ej. destornilladores) salvo que esté expresamente permitido en determinados casos.
- Realización de modificaciones o transformaciones en el producto.
- Utilización después de hurto.
- Utilización de productos con daños o defectos claramente reconocibles.
- Utilización de accesorios de otros fabricantes que no estén expresamente autorizados por Leica Geosystems.



Aviso

El uso impropio puede producir una lesión, un error en el funcionamiento o daños materiales.

La persona responsable del equipo informará al usuario sobre los peligros en el uso del equipo y sobre las medidas de protección necesarias. El producto sólo se pondrá en funcionamiento cuando el usuario haya recibido la correspondiente instrucción sobre su uso.

4.3

Límites de empleo

Ambiente

Emplear el aparato únicamente en recintos secos y en un ambiente no hostil.

4.4

Ámbitos de responsabilidad

Fabricante del producto

Leica Geosystems AG, CH-9435 Heerbrugg (en adelante Leica Geosystems) asume la responsabilidad del suministro del producto en perfectas condiciones técnicas de seguridad, inclusive su manual de empleo y los accesorios originales.

Fabricantes de accesorios que no sean Leica Geosystems

Los fabricantes de accesorios que no sean Leica Geosystems para el producto tienen la responsabilidad del desarrollo, la implementación y la comunicación de los conceptos de seguridad correspondientes a sus productos y al efecto de los mismos en combinación con el producto de Leica Geosystems.

Persona encargada del producto

La persona encargada del producto tiene las siguientes obligaciones:

- Entender la información de seguridad que figura en el producto así como las correspondientes al Manual de empleo.
 - Conocer las normas locales de seguridad y de prevención de accidentes.
 - Informar a Leica Geosystems en cuanto en el equipo o las aplicaciones muestren defectos de seguridad.
-



Aviso

El encargado del producto tiene la responsabilidad de que el equipo se utilice conforme a las normas establecidas. Esta persona también es responsable de la instrucción de los usuarios del equipo y de la seguridad en la utilización del equipo.

4.5

Peligros durante el uso

Aviso

Una instrucción incompleta o inexistente puede derivar en el manejo inadecuado o impropio del equipo, con el consiguiente riesgo de accidentes que provocarían graves daños físicos, materiales, económicos y medioambientales.

Medidas preventivas:

Todos los usuarios deben cumplir con las instrucciones de seguridad del fabricante y con las instrucciones del encargado del producto.

Aviso

El cargador no está diseñado para ser empleado en ambientes adversos y húmedos. En caso de que se infiltre humedad en el aparato, puede recibir una descarga eléctrica.

Medidas preventivas:

Emplear el cargador exclusivamente en interiores secos y protegerlo contra la humedad. Abstenerse de utilizarlo en caso de que se haya mojado.

Aviso

Al abrir el cargador, el usuario corre el riesgo de electrocutarse a causa de:

- El contacto con elementos conductores
- Utilizar el cargador después de una reparación inadecuada.

Medidas preventivas:

No abrir el cargador. Únicamente los talleres de servicio autorizados por Leica Geosystems pueden reparar estos productos.

Aviso

Las baterías que no sean recomendadas por Leica Geosystems pueden sufrir daños al cargarse o descargarse. Pueden incendiarse y llegar a explotar.

Medidas preventivas:

Solo cargue y descargue baterías recomendadas por Leica Geosystems.

Aviso

Si el producto se elimina de forma indebida pueden producirse las siguientes situaciones:

- Al quemar piezas de plástico se producen gases tóxicos que pueden ser motivo de enfermedad para las personas.
- Si se dañan o calientan intensamente las baterías, pueden explotar y causar intoxicaciones, quemaduras, corrosiones o contaminación medioambiental.
- Si el producto se desecha de forma irresponsable, es posible que personas no autorizadas utilicen el equipo de modo impropio. Esto podría causar graves lesiones a terceros así como contaminación medioambiental.

Medidas preventivas:



No desechar el producto con la basura doméstica.

Eliminar el producto correctamente. Cumplir con las normas de eliminación específicas del país.

Proteger el equipo en todo momento impidiendo el acceso a él de personas no autorizadas.

Las especificaciones para el manejo y desecho del producto se pueden descargar de la página web de Leica Geosystems en <http://www.leica-geosystems.com/treatment> o solicitarla directamente a su representante Leica Geosystems.

4.6

Compatibilidad electromagnética EMC

Descripción

Denominamos compatibilidad electromagnética a la capacidad del producto de funcionar perfectamente en un entorno con radiación electromagnética y descarga electrostática, sin causar perturbaciones electromagnéticas en otros aparatos.

Aviso

Posibilidad de interferir con otros aparatos a causa de radiación electromagnética.

Aunque el producto cumple los severos requisitos de las directivas y normas aplicables, Leica Geosystems no puede excluir por completo la posibilidad de la perturbación de otros aparatos.

Cuidado

Posibilidad de perturbación de otros aparatos cuando el producto se utilice en combinación con accesorios de terceros, por ejemplo, ordenadores de campo, PCs, radiotransmisores, cables diversos o baterías externas.

Medidas preventivas:

Utilice sólo el equipo y los accesorios recomendados por Leica Geosystems. Ellos cumplen en combinación con el producto los severos requisitos de las directivas y normas aplicables.

Aviso

Si el producto está funcionando con un cable conectado sólo por uno de sus extremos, p.ej. cable de alimentación externa o cable de interfaz, se pueden sobre-pasar los valores de radiación electromagnética permitidos y perturbar otros aparatos.

Medidas preventivas:

Mientras se esté trabajando con el producto los cables han de estar conectados por los dos lados, p.ej. del producto a la batería externa.

4.7

Normativa FCC (aplicable en EE UU)

Aviso

Los tests efectuados han puesto de manifiesto que este equipo se atiene a los valores límite, determinados en la sección 15 de la normativa FCC, para instrumentos digitales de la clase B.

Esto significa que el instrumento puede emplearse en las proximidades de lugares habitados, sin que su radiación resulte molesta.

Los equipos de este tipo generan, utilizan y emiten una frecuencia alta y, en caso de no ser instalados conforme a las instrucciones, pueden causar perturbaciones en la recepción radiofónica.

En todo caso, no es posible excluir la posibilidad de que se produzcan perturbaciones en determinadas instalaciones.

Si este equipo causa perturbaciones en la recepción radiofónica o televisiva, lo que puede determinarse al apagar y volver a encender el equipo, el operador puede intentar corregir estas interferencias de la forma siguiente:

- cambiando la orientación o la ubicación de la antena receptora.
- aumentando la distancia entre el instrumento y el receptor.
- conectando el instrumento a un circuito distinto al del receptor.
- asesorándose por el vendedor o algún técnico de radio-televisión.

 **Aviso**

Si en el instrumento se efectúan modificaciones que no estén explícitamente autorizadas por Leica Geosystems, el derecho de uso del mismo por parte del usuario puede verse limitado.

ES

Rótulo

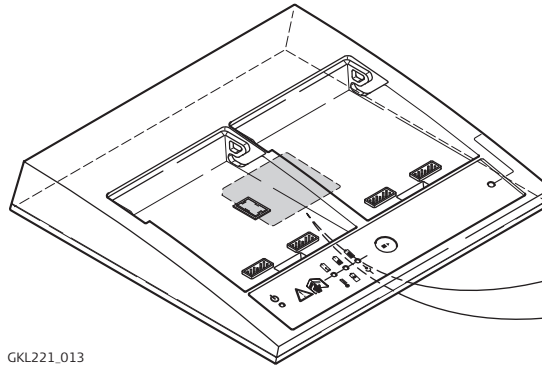

GKL221_013

Type: GKL221

Art.No.:

.....
.....
.....
.....
.....
.....

This device complies with part 15 of the FCC Rules. Operation is subject to the following two conditions: (1) This device may not cause harmful interference, and (2) this device must accept any interference received, including interference that may cause undesired operation.

5

Datos técnicos

Suministro de energía

- Conexión a la red, ~
- Voltaje de conexión D/C, ==

Voltaje de entrada

- 100 - 240 VAC, 50/60 Hz
- 24VDC

Fuente de alimentación para carga

Máximo 18 VDC / máximo 4.0 A; depende del tipo de batería

Descarga

4 W

Valor nominal de potencia

~ : 75 W == : 55 W

Entorno de trabajo

Utilizar sólo en recintos secos (edificios, vehículos)
IP40, en conformidad con IEC60529

Rango de temperaturas

Almacenaje:	-40°C a +70°C	-40°F a +158°F
Funcionamiento: ~ :	0°C a +40°C	+32°F a 104°F
== :	0°C a +50°C	+32°F a 122°F

Modos de carga

Modo de **carga rápida** para:

- Todas las baterías Leica Geosystems . Permite el control de temperatura y reconocimiento del tipo de batería. La corriente de carga es máximo de 4.0 A, dependiendo de la batería.
- Todas las baterías de cámara de vídeo estándar con tres superficies de contacto y control de temperatura. Corriente de carga máxima de 1.6 A

Modo de **carga normal** para:

- Baterías de NiCd y NiMH con temperatura menor a +10°C.
- Baterías de ion Li con temperatura menor a +6°C

- Baterías de ion Li, NiCd y NiMH casi o totalmente descargadas.

Modo de **carga de conservación** para:

- Baterías de NiCd y NiMH La corriente de carga depende del tipo de batería. La carga se realiza por turnos de aprox. quince segundos por batería.



Las baterías de ion Li no requieren carga de conservación, debido a que no pierden su carga mientras no se utilizan.

Tecnología de carga

Condiciones desactivadas en el modo de carga rápida:

Para baterías de NiCd y NiMH:

Temporizador
 Capacidad
 Temperatura de batería
 Diferencia negativa de voltaje
 Incremento de temperatura por minuto
 Método de doble inflexión

Para baterías de ion Li:

Temporizador
 Capacidad
 Temperatura de batería
 Corriente de carga

ES

Carga de conservación para baterías de NiCd y NiMH:

Controla el voltaje de la batería, corriente de carga y temperatura de la batería.

Tipo de celda

- NiCd
- NiMH
- Ion Li

Tiempos de recarga y descarga

Los tiempos de recarga y descarga dependen básicamente de la corriente de carga y descarga, la capacidad de la batería y el estado de la carga al estar conectado.

Se pueden ofrecer las siguientes instrucciones:

Carga rápida a 20°C:

Baterías de NiCd

máx 2200 mAh 1.0 a 1.5 h

máx 7200 mAh 2.5 a 4.0 h

Baterías de NiMH

máx 2200 mAh 1.5 a 2.0 h

máx 4900 mAh 2.0 a 2.5 h

máx 10000 mAh 2.5 a 5.5 h

Baterías de ion Li

máx 4600 mAh 2.5 a 3.5 h

Descarga:

Para baterías de NiCd y NiMH:

Baterías de 6V con 600 mAh por hora

Baterías de 12V con 300 mAh por hora

Baterías de ion Li

Baterías de 7.4V con 500 mAh por hora

Indicación

Consulte la sección "2.6 Indicadores".

Peso

Cargador, incluyendo dos adaptadores para batería: 1.12 kg

Dimensiones

A X L X A: máximo 237 mm x 227 mm x 43 mm; incluyendo el adaptador para batería

Leica GKL221 Caricabatterie

Manuale d'istruzioni

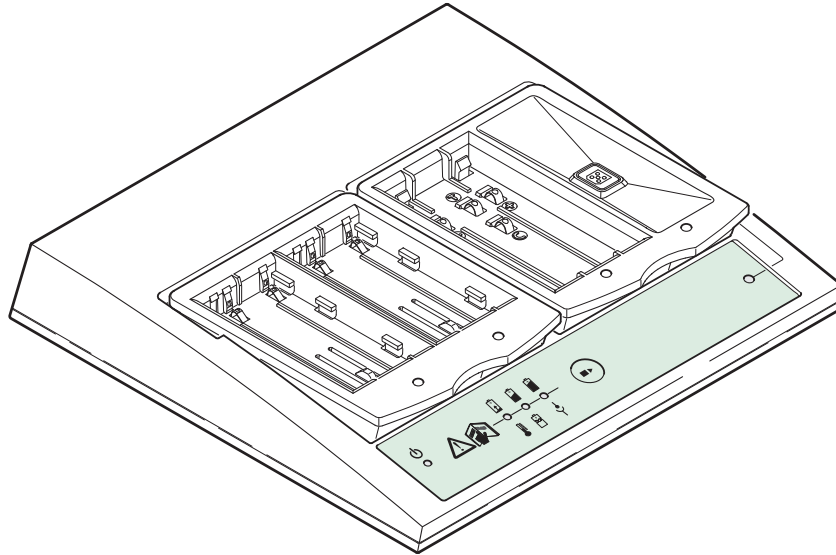

Versione 1.3
Italiano

- when it has to be **right**

Leica
Geosystems

Introduzione



Il presente manuale contiene, oltre le istruzioni sull'uso, anche delle importanti norme di sicurezza. Vedere il capitolo "4 Norme di sicurezza" per ulteriori informazioni. Si prega di leggere le istruzioni per l'uso con attenzione prima di mettere in funzione lo strumento.

Identificazione del prodotto





Il modello e il numero di serie del prodotto sono incisi sulla targhetta. Trascrivere il modello e il numero di serie dell'apparecchio nell'apposito spazio e fornire sempre questi dati ogni qualvolta si contatta il rappresentante di zona o un centro di assistenza tecnica autorizzato Leica Geosystems.

Tipo: _____

N. di serie: _____

Significato dei simboli

I simboli utilizzati nelle presenti istruzioni hanno il seguente significato:

Tipo	Descrizione
 Pericolo	Situazione di pericolo imminente che, come conseguenza, provoca la morte o gravi danni alle persone.
 Avvertimento	Indica una situazione potenzialmente pericolosa che, se non evitata, potrebbe tradursi in morte o danni fisici gravi alle persone.
 Attenzione	Indica una situazione potenzialmente pericolosa che, se non evitata, potrebbe tradursi in danni fisici di minore entità e/o in gravi danni economici, all'equipaggiamento e all'ambiente.
	Introduce indicazioni importanti a cui bisogna attenersi per usare lo strumento in modo tecnicamente corretto ed efficiente.

Sommario	Argomento	Pagina
1	Descrizione del sistema	4
2	Utilizzo	8
	2.1 Adattatore per batteria	8
	2.2 Collegamento del caricabatterie	9
	2.3 Utilizzo ed estrazione delle batterie	11
	2.4 Tasto di selezione	14
	2.5 Carica delle batterie	15
	2.6 Indicatori luminosi	17
	2.7 Suggerimenti	20
3	Manutenzione e trasporto	21
	3.1 Trasporto	21
	3.2 Custodia	21
	3.3 Cura	21
4	Norme di sicurezza	22
	4.1 Indicazioni generali	22
	4.2 Uso previsto dell'apparecchiatura	22
	4.3 Limiti all'uso	23
	4.4 Responsabilità	23
	4.5 Rischi insiti nell'uso	24
	4.6 Compatibilità elettromagnetica (CEM)	25
	4.7 Dichiarazione FCC, valida negli USA	26
5	Dati tecnici	28

Descrizione

GKL221 di Leica Geosystems è un caricabatterie con tecnologia di carica avanzata, pertanto è particolarmente indicato per caricare tutte le batterie Leica Geosystems, sia dalla rete elettrica sia dalla rete di bordo degli autoveicoli, grazie all'apposito adattatore GDC221. Il caricabatterie rappresenta un completamento ideale per i prodotti Leica Geosystems azionati a batteria.

Informazioni generali

Al caricabatterie possono essere collegate fino a cinque batterie.
Possono essere ricaricate due batterie contemporaneamente. Le batterie vengono caricate secondo l'ordine in cui sono state inserite nell'apparecchio.
Il caricabatterie, oltre alla ricarica delle batterie, consente altre funzioni come la scarica, la carica di mantenimento o la rigenerazione di batterie.



Si consiglia di mettere in funzione l'apparecchio seguendo passo passo le presenti istruzioni per l'uso.

Componenti del sistema

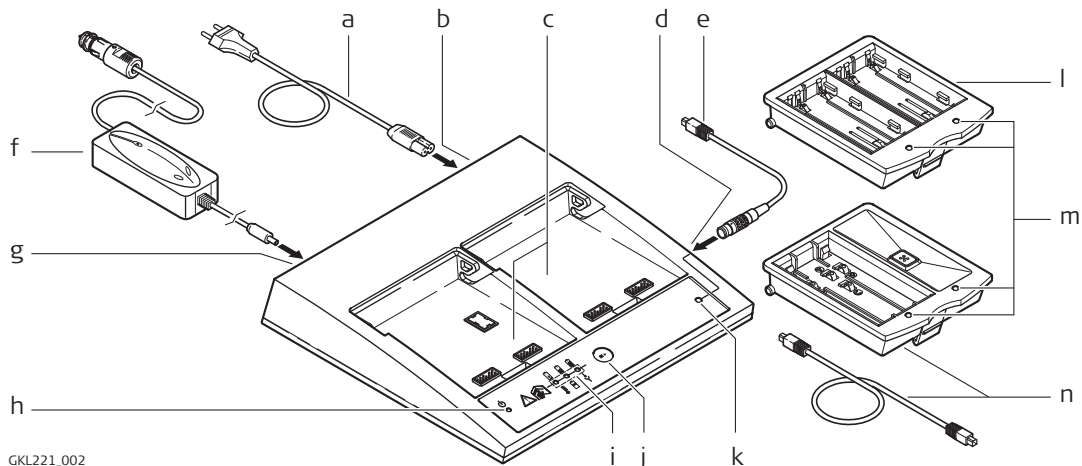

GKL221_002

- a) Cavo di alimentazione, specifico per ogni paese
- b) Attacco per il cavo di alimentazione
- c) Sedi I e II per gli adattatori per batteria GDI221 / GDI222
- d) Attacco per batterie esterne
- e) Cavo di carica per batterie esterne a 5 poli
- f) Adattatore per autoveicoli GDC221, opzionale
- g) Attacco per adattatore per autoveicoli
- h) Indicatore di funzionamento
- i) Indicatori di capacità o di segnalazione delle anomalie
- j) Tasto di selezione
- k) Indicatore di stato per l'attacco di batterie esterne
- l) Adattatore per batterie GDI221, opzionale
- m) Indicatori di stato delle batterie
- n) Adattatore per batterie GDI222 e relativo cavo di carica a 5 poli, opzionale

Batterie ricaricabili

Possono essere ricaricate le seguenti batterie Leica Geosystems:

GEB90
GEB211
GEB212
GEB221
GEB222
GEB241
GEB242



GEB111
GEB121

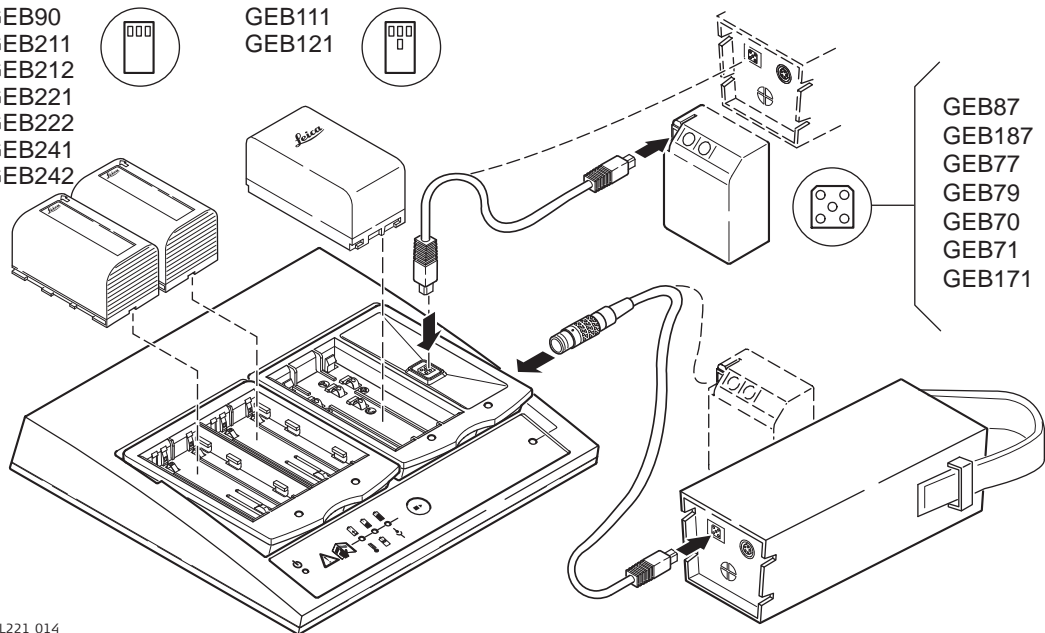

GKL221_014



Il caricabatterie è adatto solo per la scarica e la ricarica di batterie originali Leica Geosystems e di diverse batterie NiMH/NiCd per videocamere comunemente disponibili in commercio. Vedere il capitolo "2.3 Utilizzo ed estrazione delle batterie" per ulteriori informazioni.

Caricabatterie e adattatore per batterie

Le combinazioni possibili del caricabatterie con i vari adattatori per batterie consentono di collegare e ricaricare le seguenti batterie:

Caricabatterie / adattatore per batterie	Batterie ricaricabili
GKL221 con due GDI221	Fino a quattro batterie agli Li-Ion e una batteria con presa di carica a 5 poli.
GKL221 con una GDI221 e una GDI222	Fino a due batterie Li-Ion, una batteria formato videocamera e due batterie con presa di carica a 5 poli.
GKL221 con due GDI222	Fino a due batterie in formato videocamera e tre batterie con presa di carica a 5 poli.

IT

2

2.1

Utilizzo

Adattatore per batteria

Scopo

Gli adattatori per batteria servono a collegare il caricabatterie alle relative batterie e sono dotati, per ogni vano di carica, di un LED che indica lo stato di carica della batteria.

Tipi

Sono disponibili i seguenti tipi di adattatore per batteria:

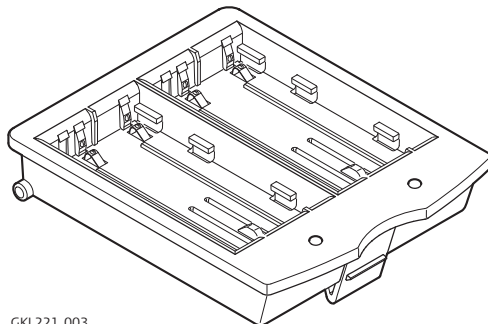

GKL221_003

GDI221

- Per due batterie Leica Geosystems agli Li-Ion GEB90, GEB211, GEB212, GEB221, GEB222, GEB241 o GEB242.

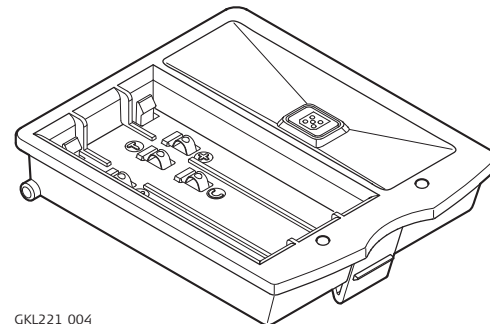

GKL221_004

GDI222

- Per una batteria NiMH Leica Geosystems GEB111 o GEB121 oppure una batteria NiCd o NiMH a 5 poli.

Utilizzo, estrazione

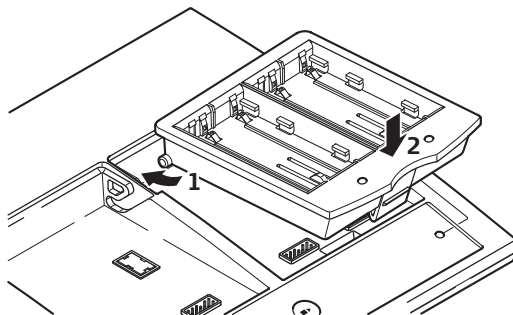

GKL221_005

Utilizzo

1. Introdurre l'adattatore con la guida posteriore.
2. Bloccarlo in posizione facendo pressione sulla parte posteriore. Si deve sentire chiaramente lo scatto.

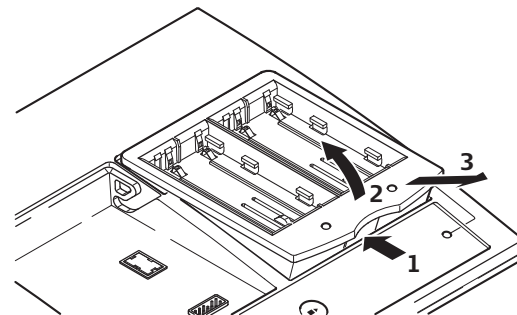

GKL221_006

Estrazione

1. Sbloccare l'adattatore per batteria facendo pressione sulla linguetta anteriore.
2. Tirare leggermente verso l'alto fino all'arresto.
3. Estrarre l'adattatore dal davanti.

2.2

Collegamento del caricabatterie

Avvertimento

Usate il caricabatterie solo al chiuso, in ambienti asciutti! Le unità che si sono bagnate non devono essere utilizzate!

Messa in funzione

Prima di mettere in funzione l'apparecchio, verificare che sia appoggiato in modo stabile.

Collegare il caricabatterie:

- alla rete elettrica mediante il cavo di alimentazione, oppure
- alla rete di bordo del veicolo con l'adattatore per auto GDC211 disponibile come optional.



Per un distacco sicuro dalla rete elettrica e se non si utilizza il caricabatterie per un periodo di tempo prolungato, staccare la spina del cavo di alimentazione o la spina dell'adattatore per autoveicolo.



Alimentare il caricabatterie con un adattatore per autoveicoli solo se collegato alla rete di bordo di un veicolo. Nel caso di alimentazione tramite altri sistemi (ad es. unità di alimentazione con limitatore di corrente) potrebbero verificarsi anomalie di funzionamento. Vedere il capitolo "5 Dati tecnici" per informazioni sulla tensione di ingresso e sulla potenza nominale.



Se si utilizzano autoveicoli non più recenti, fare attenzione alla corretta polarità dell'accendino (verificare che il polo positivo sia sul contatto centrale). In caso di una errata polarità è necessario sostituire il fusibile del caricabatterie o dell'adattatore per autoveicoli. Il fusibile del caricabatterie deve essere sostituito presso un centro di assistenza autorizzato Leica Geosystems. La sostituzione del fusibile nell'adattatore per autoveicoli deve essere eseguita in conformità al relativo manuale di istruzioni.

Verifica di funzionamento

Una volta collegato l'adattatore per batterie alla rete di alimentazione o alla rete del veicolo, gli indicatori di stato si accendono diventando prima rossi, quindi gialli e infine verdi, mentre le spie di segnalazione della capacità e delle anomalie si accendono, prima rosse, poi verdi. In questo modo è possibile verificare il corretto funzionamento.

Se non è collegata alcuna batteria, resta accesa solo la spia di funzionamento verde.

Se le spie che segnalano lo stato e i tre indicatori di capacità e di segnalazione delle anomalie restano rossi, l'apparecchio ha rilevato un'anomalia. Vedere il capitolo "2.6 Indicatori luminosi" per ulteriori informazioni.

2.3

Utilizzo ed estrazione delle batterie

Batterie Li-Ion

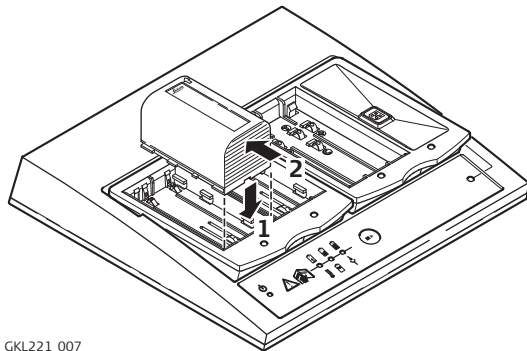

GKL221_007

Utilizzo

1. Inserire la batteria a filo con lo spigolo anteriore del vano batteria GDI221.
2. Fare scivolare in avanti la batteria premendola leggermente fino all'arresto.

Estrazione

- Fare scivolare all'indietro la batteria fino all'arresto ed estrarla.

Avvertimento

Usare il caricabatterie solo per ricaricare batterie consigliate da Leica Geosystems. Utilizzare esclusivamente batterie Li-Ion Leica Geosystems.

IT

Batterie NiCd e NiMH

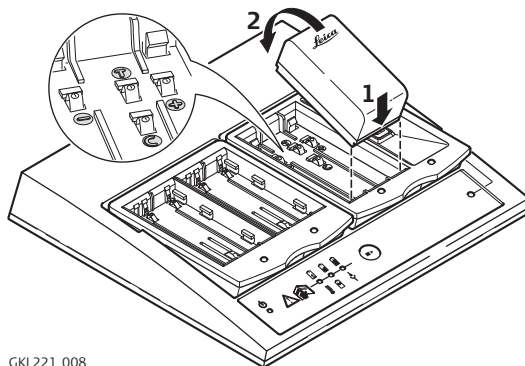

GKL221_008

Utilizzo

1. Collocare la batteria sullo spigolo anteriore del vano batteria GDI222.
2. Premere verso il basso fino a quando si sente chiaramente uno scatto.

Estrazione

- Fare scivolare posteriormente e sollevare la batteria fino ad estrarla.

IT



Le batterie Leica Geosystems GEB111 e GEB121 hanno quattro superfici di contatto, mentre le batterie per videocamere di altri produttori ne hanno solo tre. Il caricabatterie è in grado di distinguere i diversi tipi e di adattare di conseguenza la procedura di carica.



Per evitare qualsiasi danno, le batterie per videocamere con tre superfici di contatto devono soddisfare le seguenti condizioni:

- tensione: 6 V
- tipo di elemento: NiCd o NiMH
- capacità minima: NiCd 1500 mAh, NiMH 1800 mAh
- contatti compatibili con la corretta disposizione, ovvero "+, T, -" in sequenza

Le batterie per videocamere che soddisfano queste condizioni vengono caricate con una corrente di carica di 1,6 A con controllo della temperatura.

Batterie con presa di carica a 5 poli

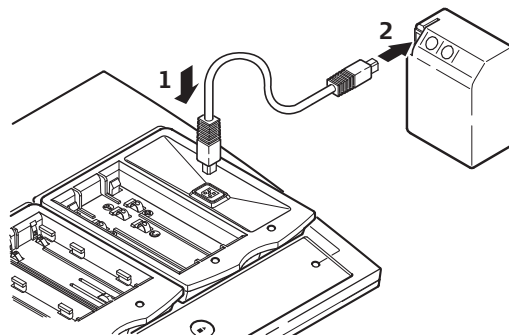

GKL221_009

Le batterie Leica Geosystems con connettore di carica a 5 poli, come le GEB87 o le GEB70, devono essere collegate al connettore a 5 poli tramite il cavo di carica.

Batterie esterne con connettore di carica a 5 poli

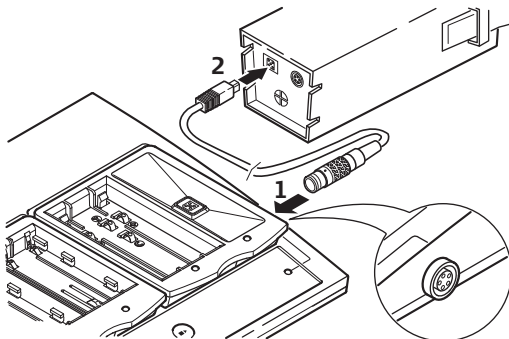

GKL221_010

Le batterie Leica Geosystems con connettore di carica a 5 poli, come le GEB87 o le GEB70, devono essere collegate al collegamento esterno alla batteria tramite il cavo di carica.

Le batterie collegate tramite collegamento esterno possono essere caricate preferibilmente senza interrompere un'eventuale operazione di ricarica già iniziata.

IT

2.4

Tasto di selezione

Funzionamento

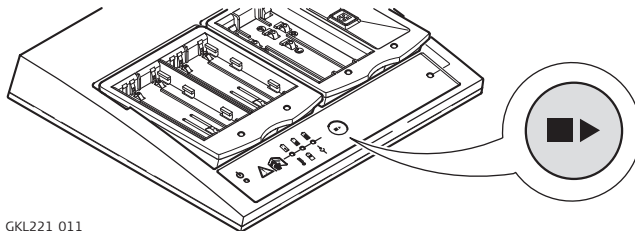

GKL221_011

Il tasto di selezione serve a selezionare un vano di carica o a commutare tra procedura di ricarica e scarica.

Funzionamento	Premere il tasto di selezione	Descrizione
Selezionare il vano di carica	Per meno di due secondi	Viene selezionato il successivo vano in cui è inserita una batteria. L'indicatore di stato corrispondente al vano selezionato diventa giallo e lampeggia rapidamente per tre secondi, quindi viene visualizzata la capacità della batteria.
Commutazione tra procedura di carica e scarica	Per più di tre secondi	Quando si passa alla modalità di scarica, l'indicatore di stato diventa giallo-rosso e lampeggia, mentre quando si passa alla modalità di carica la spia diventa gialla-verde e lampeggia per circa cinque secondi.



Durante la modalità di scarica l'indicatore di stato diventa rosso e lampeggia. Una volta conclusa la fase di scarica, l'indicatore di stato ritorna verde, ad indicare che la batteria è di nuovo sotto carica.

2.5

Carica delle batterie

Procedura

Fase	Descrizione
1.	Inserire l'adattatore per batterie.
2.	Collegare il caricabatterie all'alimentazione elettrica, l'indicatore di funzionamento diventa verde.
3.	Inserire la batteria. L'indicatore di stato diventa giallo e lampeggia ad indicare che la batteria è stata riconosciuta.
4.	Assicurarsi che l'indicatore di stato resti acceso sul verde. Ora la batteria si sta caricando. Se una volta collegata la batteria si accende un'altra spia di stato, consultare il capitolo "2.6 Indicatori luminosi".  Controllate nuovamente l'indicatore di stato dopo circa un minuto.
5.	Quando la batteria è completamente carica, l'indicatore di stato diventa verde e lampeggia. Vedere il capitolo "5 Dati tecnici" per informazioni sui tempi di carica.
6.	A questo punto è possibile togliere la batteria oppure lasciarla sul caricabatterie, così da averla sempre carica in caso di bisogno. Per ulteriori informazioni consultare il capitolo "Tipi di carica".

Definire la sequenza di carica

Il caricabatterie GKL221 può caricare due batterie alla volta. Se al caricabatterie viene collegata più di una batteria, le batterie vengono ricaricate nella sequenza in cui sono state inserite nel caricabatterie. Quindi è preferibile inserire per prima la batteria che deve essere caricata con più urgenza.

Priorità

Le batterie collegate tramite collegamento esterno possono essere caricate preferibilmente senza interrompere un'eventuale operazione di ricarica già iniziata.



Carica di mantenimento

Le batterie già cariche possono comunque restare collegate al caricabatterie. Le batterie NiCd e NiMH vengono sottoposte in sequenza ad una fase di carica di mantenimento. In questo modo si compensa

l'autoscarica delle batterie dovuta a motivi tecnici e le batterie sono sempre disponibili a piena capacità. Vedere il capitolo "Tipi di carica" per ulteriori informazioni.

Rigenerazione batterie



La funzione di rigenerazione consiste in una scarica completa della batteria e successiva ricarica rapida.

Fase	Descrizione
1.	Collegare il caricabatterie all'alimentazione di energia elettrica.
2.	Inserire la batteria. L'indicatore di stato diventa giallo e lampeggia ad indicare che la batteria è stata riconosciuta.
3.	Premere il tasto di selezione per più di tre secondi. La batteria comincia a scaricarsi. La fase di scarica in corso è indicata dalla spia rossa lampeggiante dell'indicatore di stato.  In caso di batterie di notevoli dimensioni, la fase di scarica può durare molto tempo. Per ridurre il tempo di scarica questa funzione dovrebbe essere utilizzata solo con batterie già scariche o quasi scariche!
4.	Quando la batteria è completamente scarica, viene avviata automaticamente la ricarica rapida. L'indicatore di stato resta acceso sul verde.
5.	Quando la batteria è completamente carica, l'indicatore di stato diventa verde e lampeggia.
	Nel caso delle batterie NiCd e NiMH, quando si nota che la capacità è diminuita in modo evidente, è consigliabile sottoporre la batteria a due o tre procedure di rigenerazione.
	Nel caso delle batterie Li-Ion, invece, è sufficiente un solo ciclo di scarica e ricarica. Consigliamo di procedere alla rigenerazione quando la capacità della batteria indicata sul caricabatterie o su un altro prodotto Leica Geosystems si discosta notevolmente dalla capacità effettivamente disponibile.



2.6

Indicatori luminosi





Significato dei simboli

Simbolo	Significato
	LED spento.
	LED sempre acceso.
	LED lampeggiante.

Indicatore di funzionamento

Simbolo	LED	Significato
	Spento	Il caricabatterie è collegato ad una fonte di energia.
	Verde	Il caricabatterie è collegato ad una fonte di energia.

Indicatore di stato

Simbolo	LED	Significato
	Spento	Nessuna batteria riconosciuta collegata.
	Giallo	Il caricabatterie ha riconosciuto una batteria collegata. La batteria è in modalità di attesa poiché al momento si stanno caricando o scaricando altre due batterie.
	Verde	La batteria collegata si sta ricaricando.
	Verde	La batteria collegata è stata completamente ricaricata e può essere rimossa.

Indicatori di capacità o di segnalazione delle anomalie

Indicatori di capacità

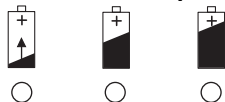

Simbolo	LED	Significato
	Rosso	Il caricabatterie ha riconosciuto un'anomalia.
	Rosso	Batteria collegata per la rigenerazione. La batteria si sta scaricando.
	Giallo	Indicazione del vano attivo, ovvero selezionato.

- Nel funzionamento normale, i tre indicatori di capacità e di segnalazione delle anomalie visualizzano in verde la capacità della batteria nel vano selezionato. Dopo avere selezionato il vano, l'indicazione resta visibile per circa dieci / quindici secondi, quindi si spegne.
- In caso di anomalia gli indicatori di capacità e di segnalazione delle anomalie visualizzano in rosso il codice dell'errore corrispondente al vano selezionato.

LED	Significato
	Stato di carica della batteria inferiore al 20%.
	Stato di carica della batteria pari ad almeno il 20%.
	Stato di carica della batteria pari ad almeno il 50%.
	Stato di carica della batteria pari ad almeno l'80%.



Attualmente l'indicatore di capacità funziona solo con batterie Leica Geosystems modello GEB211, GEB212, GEB221, GEB222, GEB241, GEB242 e GEB90.

Segnalazione errori

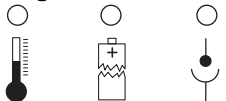

LED	Significato	Misure
	Anomalie dovute a temperatura insufficiente o eccessiva della batteria.	Vedere il capitolo "Campo di temperatura" per ulteriori informazioni.
	Batteria difettosa.	Utilizzare un'altra batteria.
	Contatto difettoso della batteria o dell'adattatore.	Verificare i contatti.
	Guasto hardware del caricabatterie.	Rivolgersi ad un centro di assistenza autorizzato Leica Geosystems.



Se il caricabatterie segnala un errore quando è collegata una batteria:

- Collegare un'altra batteria per verificare se l'anomalia riguarda la batteria o il caricabatterie.
- Se non è possibile risolvere il problema, rivolgersi ad un centro di assistenza autorizzato Leica Geosystems.



In caso di anomalie di funzionamento controllare anche:

- Arriva energia elettrica dalla presa di rete o dalla rete dell'autoveicolo?
- I cavi sono collegati correttamente e non sono presenti anomalie visibili?
- Se si sta utilizzando un adattatore per veicolo opzionale: gli indicatori di funzionamento dell'adattatore sono accesi?

2.7

Suggerimenti

Suggerimenti

- Per sfruttare completamente la capacità della batteria, le nuove batterie NiCd e NiMH dovrebbero essere scaricate completamente e ricaricate dalle tre alle cinque volte.
- Scaricare il più possibile le batterie nell'apparecchio. In questo modo si evita l'"effetto memoria" nelle batterie NiCd.
- Se si utilizza un adattatore per autoveicoli, le batterie dovrebbero essere caricate solo a motore acceso.



Evitare rapidi incrementi della temperatura ambiente durante la ricarica, ad es. l'irraggiamento solare diretto sul caricabatterie e sulle batterie. Un rapido aumento della temperatura ambiente può causare un'interruzione prematura della procedura di ricarica e quindi una capacità ridotta delle batterie.

3

Manutenzione e trasporto

3.1

Trasporto

Spedizione

Per la spedizione via treno, aereo o nave utilizzare sempre l'imballaggio originale completo Leica Geosystems, contenitori e cartoni idonei al trasporto e imballaggi adeguati. L'imballaggio protegge il prodotto da colpi e vibrazioni.

3.2

Custodia

Prodotto

Quando si ripone lo strumento, soprattutto in estate e all'interno di un'auto, tenere sempre presenti i limiti della temperatura di stoccaggio. Vedere il capitolo "5 Dati tecnici" per informazioni sul campo della temperatura di stoccaggio.

3.3

Cura

Prodotto

Pulire utilizzando solamente un panno pulito e morbido.

Cavi e spine

Mantenere puliti i connettori e proteggerli dall'umidità. Pulire con aria compressa i connettori sporchi all'estremità dei cavi di collegamento.

4

Norme di sicurezza

4.1

Indicazioni generali

Descrizione

Le istruzioni riportate di seguito hanno l'obiettivo di consentire al responsabile dell'apparecchiatura e all'operatore di riconoscere per tempo e quindi di evitare eventuali rischi insiti nell'uso del dispositivo.

La persona responsabile dello strumento deve verificare che tutti gli utilizzatori comprendano queste istruzioni e vi si conformino.

IT

4.2

Uso previsto dell'apparecchiatura

Usi consentiti

- Scarica e ricarica di batterie con elementi a diversa tecnologia.
-

Utilizzi non consentiti

- Uso dello strumento senza istruzioni
- Uso in condizioni non consentite
- Disabilitazione dei sistemi di sicurezza
- Rimozione delle indicazioni di rischio
- Apertura dello strumento mediante utensili, ad es. cacciaviti ecc., al di fuori dei casi in cui è espressamente consentito.
- Esecuzione di modifiche o di conversioni del prodotto
- Uso dopo appropriazione indebita
- Utilizzo del prodotto anche in presenza di difetti o danni visibili.
- Uso in associazione ad accessori prodotti da altri fabbricanti non espressamente approvati da Leica Geosystems

Avvertimento

Gli usi proibiti possono provocare danni fisici, cattivi funzionamenti e danni materiali. È compito del responsabile dello strumento informare l'operatore dei pericoli derivanti dall'utilizzo del prodotto e delle relative misure di sicurezza. Il prodotto potrà essere messo in funzione solo quando l'utilizzatore è stato istruito per il funzionamento dello stesso.

4.3

Limiti all'uso

Ambiente

Adatto solo all'uso in ambienti asciutti e non in condizioni critiche.

4.4

Responsabilità

Produttore

È responsabilità di Leica Geosystems AG, CH-9435 Heerbrugg, in breve denominata Leica Geosystems, fornire il prodotto in condizioni di assoluta sicurezza tecnica e completo di istruzioni per l'uso e di accessori originali.

Produttori degli accessori di altre marche

I fabbricanti di accessori non-Leica Geosystems utilizzabili per questo prodotto sono responsabili dello sviluppo, della realizzazione e della comunicazione dei concetti di sicurezza relativi ai loro prodotti e dell'effetto di tali concetti riguardo al prodotto Leica Geosystems.

Responsabile dell'apparecchio

La persona responsabile dell'apparecchio ha i seguenti doveri:

- Capire le norme di sicurezza del prodotto e le istruzioni contenute nel Manuale d'uso.
 - Conoscere le disposizioni locali in materia di sicurezza e di prevenzione degli infortuni.
 - Informare Leica Geosystems non appena vengono rilevati, sul prodotto o durante il suo impiego, difetti che ne pregiudicano la sicurezza.
-

Avvertimento

La persona responsabile del prodotto deve garantire che lo stesso venga usato conformemente alle istruzioni. Inoltre è responsabile dell'impiego del personale e della sua formazione, nonché della sicurezza del prodotto durante l'uso.

 **Avvertimento**

L'assenza di formazione o un'inadeguata istruzione possono determinare usi non corretti o proibiti e provocare incidenti con danni gravi a persone e materiali, economici ed ambientali.

Precauzioni:

Tutti gli utilizzatori devono attenersi alle norme di sicurezza fornite dal fabbricante e alle istruzioni della persona responsabile del prodotto.

 **Avvertimento**

Il prodotto non deve essere utilizzato in ambienti umidi e in condizioni inclementi. A causa dell'umidità eventualmente penetrata nel caricabatterie, l'utilizzatore può subire una scossa elettrica.

Precauzioni:

Utilizzare il prodotto solo al chiuso e in ambienti asciutti, come all'interno di edifici o veicoli. Proteggere il prodotto dall'umidità. Non utilizzarlo quando è umido!

 **Avvertimento**

Evitare le due azioni sotto indicate quando si apre il prodotto, in quanto esiste il rischio di scossa elettrica:

- toccare le parti sotto tensione
- usare il caricabatterie dopo un tentativo di riparazione inadeguato

Precauzioni:

Non aprire il prodotto. Le riparazioni possono essere eseguite solamente da un centro di assistenza autorizzato Leica Geosystems.

 **Avvertimento**

Se si caricano o scaricano batterie non consigliate da Leica Geosystems si rischia di danneggiarle. Sussiste inoltre il rischio di incendio o esplosione.

Precauzioni:

Usare l'apparecchio solo per ricaricare o scaricare le batterie consigliate da Leica Geosystems.

Avvertimento

Se lo strumento non viene smaltito correttamente possono verificarsi le seguenti condizioni:

- L'eventuale combustione di componenti polimeri provoca l'emissione di gas tossici dannosi per la salute.
- Se le batterie vengono danneggiate o subiscono un riscaldamento eccessivo, possono esplodere e essere causa di avvelenamento, ustioni, corrosione e contaminazione ambientale.
- Se si smaltisce lo strumento in modo irresponsabile è possibile che persone non autorizzate si trovino in condizione di utilizzarlo in deroga a quanto stabilito dalle disposizioni vigenti, esponendo se stesse e terze persone al rischio di gravi lesioni e rendendo l'ambiente soggetto a contaminazione.

Precauzioni:



Il prodotto non deve essere smaltito insieme ai rifiuti domestici.

Smaltire il prodotto adeguatamente in conformità ai regolamenti nazionali in vigore nel proprio paese.

Impedire l'accesso al prodotto da parte di persone non autorizzate.

Le informazioni sul trattamento del prodotto e la gestione dei rifiuti possono essere scaricate dalla homepage di Leica Geosystems all'indirizzo <http://www.leicageosystems.com/treatment> o richieste al rivenditore locale di Leica Geosystems.

4.6

Compatibilità elettromagnetica (CEM)

Descrizione

Il termine compatibilità elettromagnetica si riferisce alla capacità del prodotto di operare senza problemi in un ambiente nel quale sono presenti radiazioni elettromagnetiche e scariche elettrostatiche, senza causare interferenze elettromagnetiche a carico di altre apparecchiature.

Avvertimento

Le radiazioni elettromagnetiche possono causare disturbi ad altri apparecchi.

Benché i prodotti siano rigorosamente conformi ai requisiti stabiliti dalle direttive e dalle norme in materia, Leica Geosystems non può escludere completamente la possibilità di interferenze nei confronti di altre apparecchiature.

Attenzione

L'uso dello strumento con apparecchiature di altre marche, come cavi diversi o batterie esterne, può dare luogo ad interferenze nei confronti di altre apparecchiature.

Precauzioni:

Usare solo apparecchiature ed accessori raccomandati da Leica Geosystems cioè tali da soddisfare, se usati con lo strumento, i rigorosi requisiti previsti dalle linee guida e dagli standard in vigore a tale riguardo.

Avvertimento

Se il prodotto viene messo in funzione collegando solo una delle estremità dei cavi, ad es. un cavo di alimentazione esterno, è possibile che il livello consentito di radiazione magnetica venga superato, con conseguenti interferenze nel funzionamento di altri strumenti.

Precauzioni:

Durante l'uso dello strumento i cavi (ad es. strumento / batteria esterna) devono essere collegati ad entrambe le estremità.

4.7

Dichiarazione FCC, valida negli USA

Avvertimento

Questo prodotto è stato sottoposto a test e risulta conforme ai limiti stabiliti per i dispositivi digitali di classe B, conformemente a quanto previsto nella sezione 15 delle norme FCC.

Tali limiti prevedono una protezione sufficiente dalle radiazioni dannose per le installazioni in zone residenziali.

Gli apparecchi di questo tipo generano, utilizzano e possono irradiare alte frequenze, pertanto, se non vengono installati ed utilizzati conformemente alle istruzioni, possono causare interferenze dannose alle radiocomunicazioni.

Non è comunque possibile garantire che in determinate installazioni non possano verificarsi ugualmente interferenze.

Nel caso che questo strumento causi interferenze alla ricezione radiofonica o televisiva, il che è accettabile attivando e disattivando l'apparecchiatura, si invita l'utilizzatore a correggere il disturbo applicando le misure descritte di seguito.

- Orientare o collocare nuovamente l'antenna ricevente.
- Aumentare la distanza tra lo strumento e il ricevitore.
- Collegare lo strumento alla presa di corrente su un circuito diverso da quello a cui è collegato il ricevitore.
- Consultare il rivenditore o un tecnico esperto nel campo radiotelevisivo.

Avvertimento

Qualsiasi alterazione o modifica non esplicitamente approvata da Leica Geosystems può limitare il diritto dell'utente all'uso dell'apparecchiatura.

Targhette

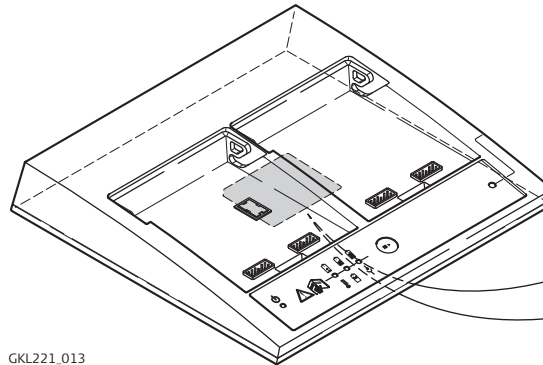

GKL221_013

Type: GKL221

Art.No.:

.....
.....
.....
.....
.....
.....
.....
.....
.....
.....
This device complies with part 15 of the FCC Rules. Operation is subject to the following two conditions: (1) This device may not cause harmful interference, and (2) this device must accept any interference received, including interference that may cause undesired operation.

Allacciamento elettrico	<ul style="list-style-type: none"> • Allacciamento alla rete, AC • Allacciamento a tensione costante, == 									
Tensione in ingresso	<ul style="list-style-type: none"> • 100 - 240 VAC, 50/60 Hz • 24VDC 									
Potenza di carica	max. 18 VDC / max. 4.0 A; a seconda del tipo di batteria									
Potenza di scarica	4 W									
Potenza nominale	AC : 75 W == : 55 W									
Campo d'impiego	Solo per uso in ambienti asciutti, come edifici o veicoli IP40, secondo IEC60529									
Campo di temperatura	<table border="0"> <tr> <td>Immagazzinaggio</td> <td>da -40°C a +70°C</td> <td>da -40°F a +158°F</td> </tr> <tr> <td>Esercizio</td> <td>AC : da 0°C a +40°C</td> <td>da +32°F a 104°F</td> </tr> <tr> <td></td> <td>== : da 0°C a +50°C</td> <td>da +32°F a 122°F</td> </tr> </table>	Immagazzinaggio	da -40°C a +70°C	da -40°F a +158°F	Esercizio	AC : da 0°C a +40°C	da +32°F a 104°F		== : da 0°C a +50°C	da +32°F a 122°F
Immagazzinaggio	da -40°C a +70°C	da -40°F a +158°F								
Esercizio	AC : da 0°C a +40°C	da +32°F a 104°F								
	== : da 0°C a +50°C	da +32°F a 122°F								
Tipi di carica	<p>La carica rapida viene effettuata su:</p> <ul style="list-style-type: none"> • Tutte le batterie Leica Geosystems. Queste batterie sono dotate di controllo della temperatura e riconoscimento della batteria. La corrente di carica max. è 4,0 A, a seconda della batteria. • Tutte le batterie standard per videocamere con tre superfici di contatto e controllo della temperatura. Corrente di carica max. 1,6 A <p>La carica lenta viene effettuata su:</p> <ul style="list-style-type: none"> • Batterie NiCd e NiMH con temperatura inferiore a +10°C. • Batterie Li-Ion con temperatura inferiore a +6°C • Batterie Li-Ion, NiCd e NiMH in gran parte o del tutto scariche. 									

La carica di mantenimento viene effettuata su:

- Batterie NiCd e NiMH. La corrente di carica dipende dalla batteria. Le batterie vengono caricate in sequenza per circa quindici secondi l'una.



Nelle batterie Li-Ion, in considerazione della bassa autoscarica, non è necessaria alcuna carica di mantenimento.

Tecnologia di carica

Criteri di arresto nella carica rapida:

Nelle batterie NiCd e NiMH:

Timer
Capacità
Temperatura batteria
Differenza di tensione negativa
Incremento di temperatura al minuto
Metodo a gradiente multiplo (metodo del punto d'inflessione)

Nelle batterie Li-Ion:

Timer
Capacità
Temperatura batteria
Corrente di carica

IT

Tipi di elementi

Carica di mantenimento con batterie NiCd e NiMH:

Monitoraggio della tensione della batteria, della corrente di carico e della temperatura della batteria.

- NiCd
- NiMH
- Li-Ion

Tempi di carica e scarica

I tempi di carica e scarica dipendono innanzi tutto dalla corrente massima di carica e scarica, dalla capacità della batteria e dallo stato di carica della stessa quando viene inserita nel caricabatterie.

Valgono i seguenti valori di riferimento:

Carica rapida a 20°C

Batterie NiCd

fino a 2200 mAh da 1,0 a 1,5 h
fino a 7200 mAh da 2,5 a 4,0 h

Batterie NiMH

fino a 2200 mAh da 1,5 a 2,0 h
fino a 4900 mAh da 2,0 a 2,5 h
fino a 10000 mAh da 2,5 a 5,5 h

Batterie Li-Ion

da 4600 mAh da 2,5 a 3,5 h

Scarica

Per batterie NiCd e NiMH

Batterie a 6V con 600 mAh /ora
Batterie a 12V con 300 mAh / ora

Batterie Li-Ion

Batterie a 7,4V con 500 mAh / ora

Display

Vedere il capitolo "2.6 Indicatori luminosi".

Peso

Caricabatterie, completo di due adattatori per batteria: 1,12 kg

Ingombro esterno

L X P X H: max 237 mm x 227 mm x 43 mm; completo di adattatori per batteria

Leica Carregador GKL221

Manual de Operação

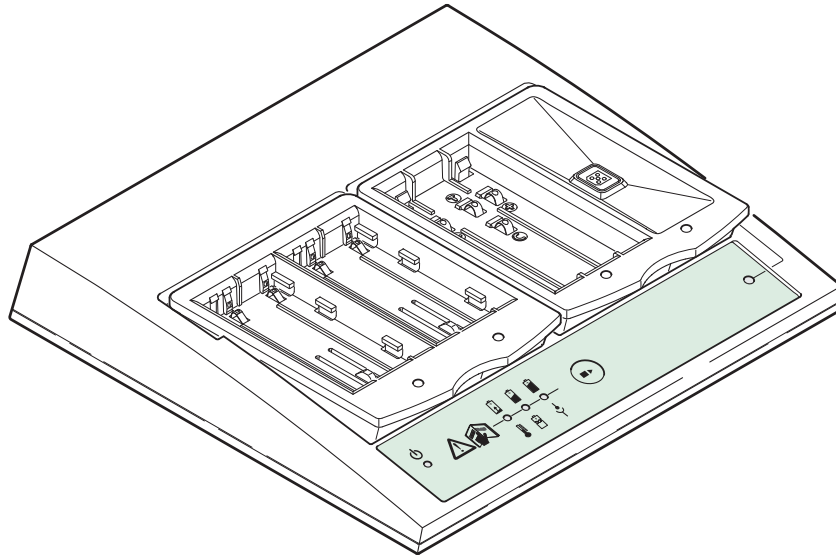

PT

Versão 1.3
Português

- when it has to be **right**

Leica
Geosystems

Introdução



Para além de instruções de utilização, este manual de operação contém também importantes instruções de segurança. Consultar o capítulo "4 Instruções de Segurança" para mais informações. Antes de utilizar o produto, ler atentamente as instruções de operação.

Identificação do produto

A indicação do modelo e do número de série do sistema encontram-se gravados na respectiva chapa de características. Tomar nota destas informações e fornecê-las sempre que for contactado algum Centro de Assistência Leica Geosystems.





Modelo: _____

Nº de série: _____

PT

Símbolos utilizados

Os símbolos utilizados no Manual de Operação possuem o seguinte significado:

Símbolo	Significado
 Perigo	Perigo iminente durante a utilização do produto e possibilidade de lesões corporais graves ou morte.
 Atenção	Perigo durante a utilização do produto ou devido a utilização incorrecta, podendo traduzir-se em lesões corporais ou morte.
 Aviso	Perigo durante a utilização ou devido a utilização incorrecta do produto, o que pode conduzir a lesões corporais ligeiras, danos graves a outros bens, perdas económicas ou agressões ambientais.
	Informação sobre a utilização do produto para ajudar a que a sua operação seja efectuada de modo correcto e eficiente

Índice	Tópico	Página
1	Descrição do sistema	4
2	Operação	8
	2.1 Adaptador de bateria	8
	2.2 Ligação do carregador	9
	2.3 Instalação e remoção das baterias	11
	2.4 Botão de selecção	14
	2.5 Carregamento da bateria	15
	2.6 Luzes avisadoras	17
	2.7 Sugestões	20
3	Cuidados e transporte	21
	3.1 Transporte	21
	3.2 Armazenamento	21
	3.3 Limpeza e secagem do produto	21
4	Instruções de Segurança	22
	4.1 Informações gerais	22
	4.2 Finalidade	22
	4.3 Limites da utilização	23
	4.4 Áreas de responsabilidade	23
	4.5 Riscos da utilização	24
	4.6 Compatibilidade electromagnética	25
	4.7 Referência FCC, Válida para os EUA	26
5	Características técnicas	28

1

Descrição do sistema

Descrição

O GKL 221 é um carregador inteligente com uma avançada tecnologia de carregamento de baterias. O carregador foi especialmente concebido para carregar todas as baterias Leica. Como fonte de alimentação pode ser utilizada uma tomada de corrente normal ou um adaptador GDC221 para ligação à tomada do isqueiro de um automóvel. O GKL 221 é um acessório muito útil para todos os produtos Leica Geosystems alimentados a baterias.

Informações gerais

O carregador pode ser utilizado para o carregamento simultâneo até 5 baterias. Através dos dois circuitos de alimentação independentes do carregador, podem ser carregadas 2 baterias ao mesmo tempo. Com mais de 2 baterias ligadas ao carregador, as restantes baterias são carregadas pela ordem em que foram ligadas. Antes do carregamento, o carregador pode também efectuar a descarga e refrescamento das baterias.



Nesta altura, recomendamos que o produto seja preparado para utilização, enquanto prossegue a leitura das Instruções de Operação.

Componentes do sistema

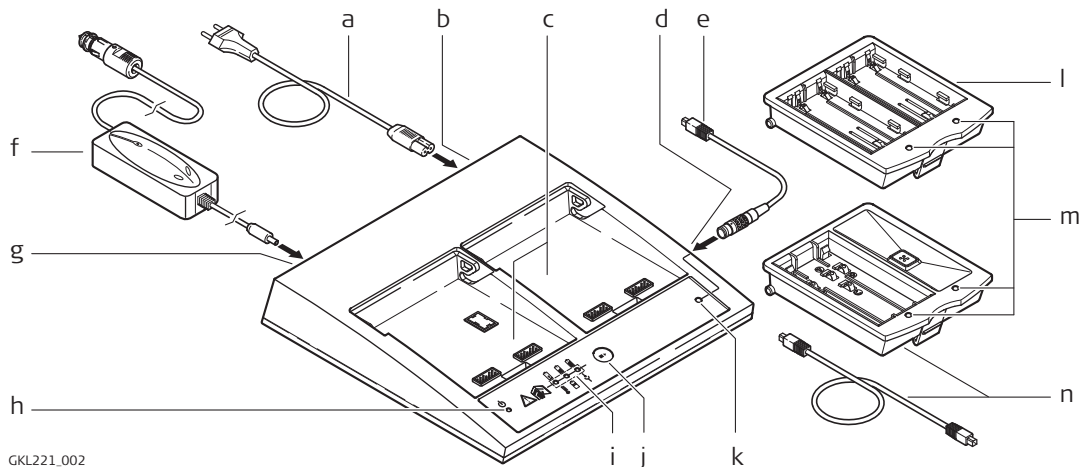

GKL221_002

- | | |
|--|--|
| a) Cabo de alimentação (para ligação da tomada normal), com ficha adequada para o país de utilização | g) Tomada para o cabo de alimentação de veículo no carregador |
| b) Tomada para o cabo de alimentação no carregador | h) Indicador de funcionamento |
| c) Adaptadores I e II para os adaptadores de baterias GDI221 / GDI222 | i) Indicadores de carga e erro |
| d) Cabo de ligação a bateria externa | j) Botão de selecção |
| e) Tomada para baterias externas de 5 pólos | k) Indicador de estado para ligação de bateria externa |
| f) Adaptador para ligação a isqueiro automóvel GDC221, opcional | l) Adaptador de bateria GDI221, opcional |
| | m) Indicadores de estado das baterias |
| | n) Adaptador de bateria GDI222 e cabo de carregamento de 5 pólos, opcional |

Baterias recarregáveis

Podem ser carregadas as seguintes baterias:

GEB90
GEB211
GEB212
GEB221
GEB222
GEB241
GEB242



GEB111
GEB121

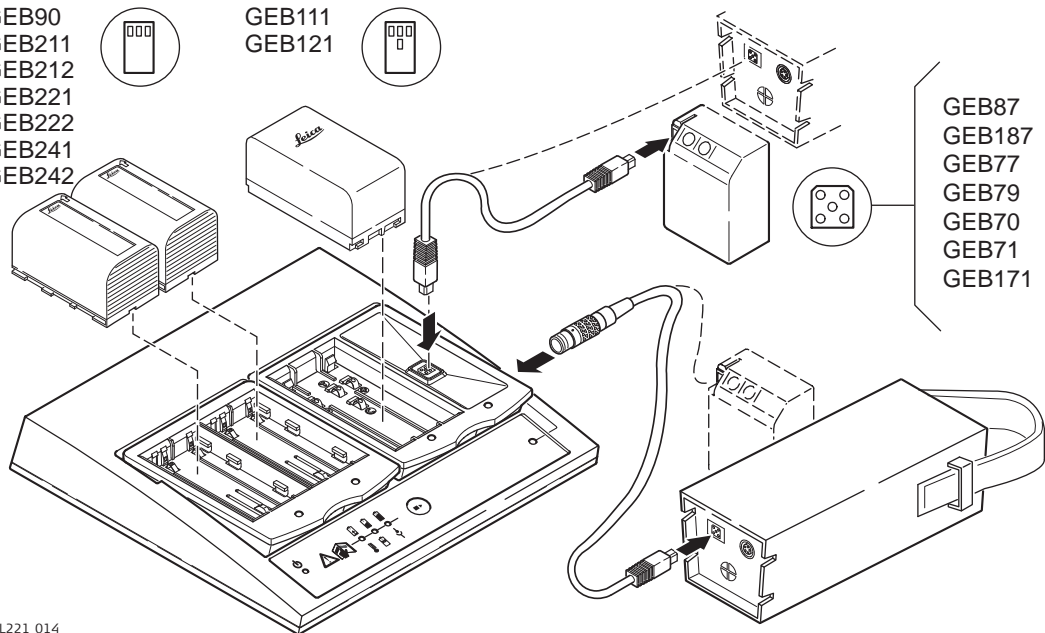

GEB87
GEB187
GEB77
GEB79
GEB70
GEB71
GEB171

GKL221_014



O carregador foi desenvolvido para carregar e descarregar baterias originais Leica, assim como algumas baterias de câmara de vídeo de NiMH ou NiCd. Consultar o capítulo "2.3 Instalação e remoção das baterias" para mais informações.

Carregador e adaptadores para baterias

A utilização do carregador com os adaptadores de baterias permite a ligação das seguintes baterias ao carregador:

Carregador / Adaptador de baterias	Baterias recarregáveis
GKL221 com dois GDI221	Até 4 baterias de íões de Li e uma bateria com tomada de 5 pólos.
GKL221 com um GDI221 e um GDI222	Até duas baterias de íões de Li, uma bateria tipo câmara de vídeo e duas baterias com tomadas de 5 pólos.
GKL221 com dois GDI222	Até duas baterias tipo câmara de vídeo e três baterias com tomadas de 5 pólos.

2

2.1

Operação

Adaptador de bateria

Finalidade

O adaptador da bateria permite ligar o carregador às respectivas baterias, apresentando um LED por cada espaço de carga, para indicação do estado de carga da bateria.

Tipo

Estão disponíveis os seguintes adaptadores:

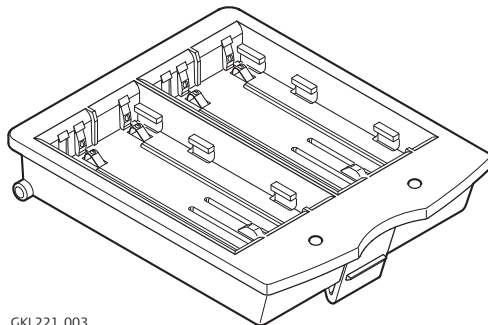

GKL221_003

GDI221

- Para duas baterias de íons de Li GEB90, GEB211, GEB212, GEB221, GEB222, GEB241 ou GEB242.

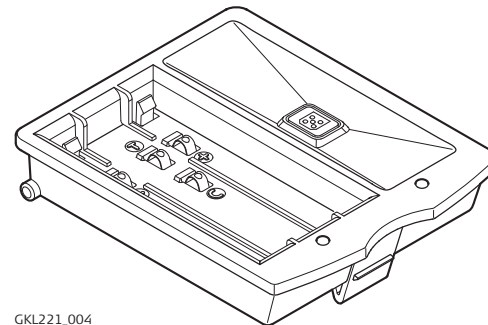

GKL221_004

GDI222

- Para uma bateria NiMH GEB111 ou GEB121 e uma bateria de NiCd ou NiMH bateria de 5 pólos.

Instalação e remoção das baterias

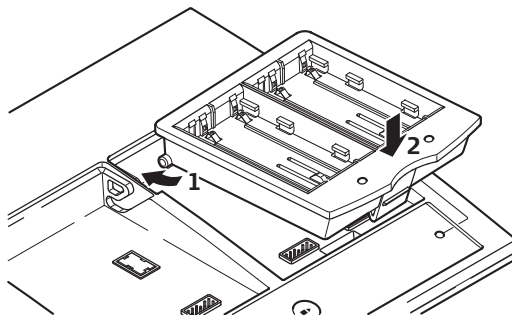

GKL221_005

Instalação

1. Introduzir o adaptador da bateria ao longo do bordo guia traseiro.
2. Premir a parte dianteira do adaptador, até encaixar com um clique.

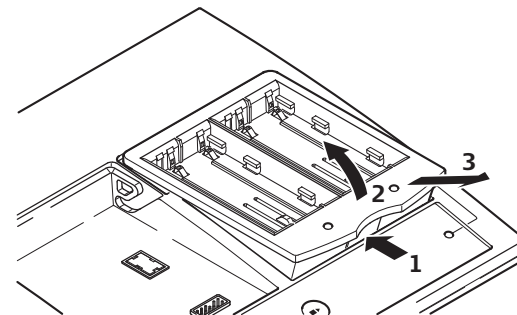

GKL221_006

Remoção

1. Premir o bordo dianteiro do adaptador para o abrir.
2. Levantar com cuidado o adaptador até ao ponto de paragem.
3. Remover o adaptador, puxando-o para a frente e para fora.

PT

2.2

Ligação do carregador

Atenção

Utilizar o carregador de baterias apenas em espaços secos! Nunca utilizar o carregador se este estiver molhado ou húmido!

Arranque

Antes de colocar o carregador em funcionamento, colocá-lo numa superfície firme.

Ligar o carregador:

- com o cabo de alimentação fornecido com o carregador a uma tomada eléctrica ou
 - com o adaptador opcional GDC211 à tomada do isqueiro de um veículo
-



Remover a ficha da tomada ou do isqueiro se o carregador não for utilizado durante um longo período de tempo.



O adaptador de isqueiro deve apenas ser utilizado em veículos automóveis. A alimentação do carregador a partir de outras fontes, como transformadores, pode provocar o seu funcionamento deficiente. Consultar o capítulo " Modos de carregamento" para mais informações sobre a tensão e potência nominais.



Em veículos mais antigos, verificar a polaridade da tomada do isqueiro: o pólo positivo (+) deve ser o contacto central da tomada. Se a polaridade for diferente, o fusível do carregador ou o fusível no adaptador do veículo deve ser substituído. O fusível no carregador deve ser substituído por um Centro de Assistência Leica Geosystems. O fusível no adaptador do veículo deve ser substituído conforme indicado no manual do adaptador.

Verificação do funcionamento

Após a ligação do carregador (a uma tomada ou à tomada de um isqueiro), as luzes avisadoras vermelha, amarela e verde acendem uma vez e as luzes avisadoras de capacidade e erro acendem de cor vermelha e verde. O acendimento das luzes indica que o carregador concluiu um teste de funcionamento.

Se não houver qualquer bateria no carregador, a luz avisadora de funcionamento (verde) acende. Se a luz avisadora de estado e as três luzes avisadoras de capacidade e de erro acederem e permanecerem acesas de vermelho, o carregador detectou uma anomalia. Consultar o capítulo "2.6 Luzes avisadoras" para mais informações.

2.3

Instalação e remoção das baterias

Baterias de íões de Li

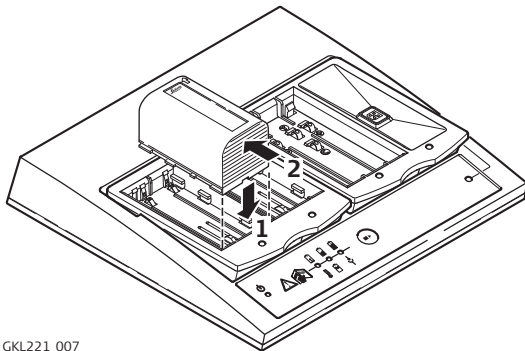

GKL221_007

Instalação:

1. Introduzir a bateria de modo a ficar à face com o bordo dianteiro do espaço da bateria GDI221.
2. Empurrar a bateria para baixo com uma ligeira pressão, até à posição final.

Remoção:

- Empurrar a bateria para trás, até à posição limite e remover depois a bateria.

Atenção

Carregar ou descarregar com o carregador apenas as baterias recomendadas pela Leica Geosystems. Utilizar apenas baterias de íões de Li da Leica Geosystems.

PT

Baterias NiCd e NiMH

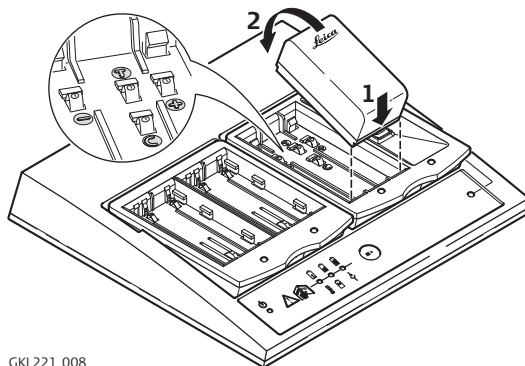

GKL221_008

Instalação:

1. Introduzir a bateria no bordo dianteiro do espaço de carga da bateria GDI222.
2. Premir a bateria para baixo, até prender e se ouvir um clique.

Remoção:

- Puxar a parte traseira da bateria para cima e remover depois a bateria.

PT



As baterias Leica Geosystems GEB111 e GEB121 apresentam 4 contactos; as baterias tipo câmara de vídeo de outros fabricantes apresentam apenas 3 contactos. O carregador distingue entre estes dois tipos de baterias e ajusta o processo de carga em conformidade.



As baterias tipo câmara de vídeo com 3 contactos devem apresentar as seguintes especificações, de modo a evitar a sua danificação:

- Tensão: 6 V
- Tipo de bateria: NiCd ou NiMH
- Capacidade mínima: NiCd 1500 mA.h, NiMH 1800 mA.h
- Contactos compatíveis na sequência correcta, i.e. "+, T, -" em linha.

As baterias tipo câmara de vídeo que satisfaçam estas especificações são controladas em termos de temperatura e carregadas com uma corrente de 1,6 A.

Baterias com tomadas de carga de 5 pólos

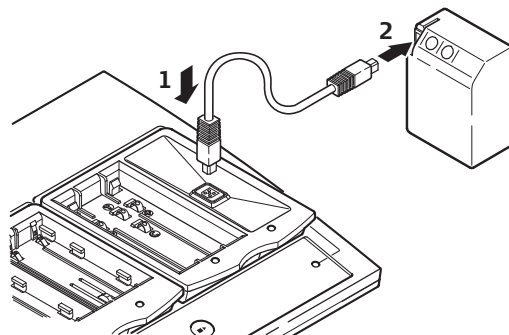

GKL221_009

As baterias Leica Geosystems com tomadas de carga de 5 pólos, como por exemplo GEB87 ou GEB70, devem ser ligadas à tomada de carga de 5 pólos do cabo.

Baterias externas com tomadas de carga de 5 pólos

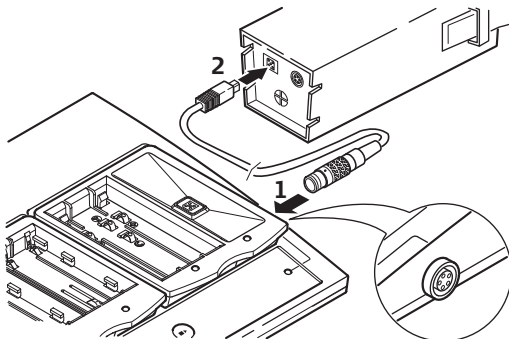

GKL221_010

As baterias Leica Geosystems com tomadas de carga de 5 pólos, como por exemplo GEB87 ou GEB70, devem ser ligadas à tomada de carga externa do cabo.

As baterias nas tomadas de ligação de bateria externa podem ser carregadas sem ter sido concluído qualquer processo de carga anterior.

PT

2.4

Botão de selecção

Funções

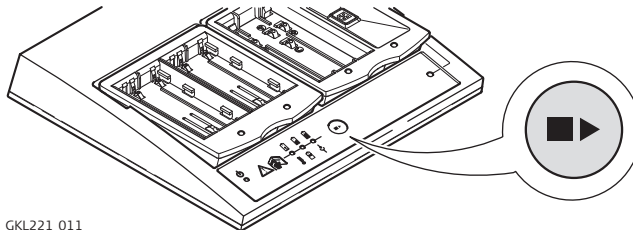

GKL221_011

O botão de selecção destina-se a seleccionar o espaço de carga no carregador e a mudar entre os modos de carga e descarga.

Funções	Premir o botão de selecção	Descrição
Seleccionar o espaço de carga	Menos de 2 segundos	É seleccionado o espaço de carga seguinte que tenha bateria. O espaço de carga é indicado pelo acendimento intermitente rápido da luz avisadora amarela durante 3 segundos; a capacidade da bateria é também indicada.
Comutação entre os modos de carga e descarga	Mais de 3 segundos	A comutação para o modo de descarga provoca o acendimento intermitente amarelo-vermelho da luz avisadora de estado durante cerca de 5 segundos; a comutação para o modo de carga provoca o acendimento intermitente amarelo-vermelho durante cerca de 5 segundos.



A descarga é indicada pelo acendimento intermitente da luz avisadora de estado vermelha. Após a conclusão do processo de descarga, a luz avisadora verde começa a piscar, indicando que a bateria se encontra carregada.

2.5

Carregamento da bateria

Procedimento

Medidas a tomar	Descrição
1.	Introduzir o adaptador da bateria.
2.	Ligar o carregador à fonte de alimentação; a luz avisadora verde (funcionamento) acende.
3.	Introduzir a bateria. A luz avisadora amarela pisca, indicando que a bateria foi reconhecida.
4.	A luz avisadora verde deve permanecer acesa. A bateria encontra-se agora em carga. Consultar o parágrafo "2.6 Luzes avisadoras", se, após a ligação da bateria, as luzes avisadoras acenderem de modo diferente do indicado.  Após cerca de 1 minuto, verificar a luz avisadora de estado.
5.	A bateria encontra-se totalmente carregada, quando a luz avisadora verde começar a piscar. Consultar o capítulo "5 Características Técnicas", para informações sobre a duração da carga.
6.	Se necessário, a bateria pode ser removida ou permanecer ligada ao carregador, para verificar se se encontra totalmente carregada. Consultar o capítulo "Modos de carregamento" para mais informações.

Configuração da sequência de carga

O carregador GKL221 permite o carregamento simultâneo de 2 baterias. Com duas baterias ligadas ao carregador, a bateria que tiver sido introduzida em primeiro lugar será a primeira a ser carregada. Assim, ligar primeiro a bateria que seja necessária em primeiro lugar.

Prioridades

As baterias são carregadas na ligação externa, sem interrupção do processo de carga já iniciado.



Manutenção da carga completa

As baterias carregadas podem permanecer ligadas ao carregador. As baterias NiCd e NiMH são carregadas em ciclos, de modo a manter a sua carga completa. Deste modo, é compensada a

auto-descarga, própria deste tipo de baterias, e a bateria encontra-se sempre carregada e pronta para utilização. Consultar o capítulo "Modos de carregamento" para mais informações.

Refrescamento das baterias



A função de refrescamento efectua a descarga total da bateria e carrega-a depois com uma carga rápida.

Medidas a tomar	Descrição
1.	Ligar o carregador à fonte de alimentação.
2.	Introduzir a bateria. A luz avisadora amarela pisca, indicando que a bateria foi reconhecida.
3.	<p>Premir o botão de selecção durante mais de 3 segundos, para iniciar o processo de descarga da bateria. A descarga é indicada pelo acendimento intermitente da luz avisadora de estado vermelha.</p> <p> As baterias de alta capacidade podem levar mais tempo a descarregar. Para manter os tempos de descarga reduzidos, utilizar esta função apenas com baterias descarregadas ou com uma carga reduzida.</p>
4.	Após a descarga da bateria, esta é colocada num ciclo de carga rápida. A luz avisadora de estado acende de cor verde.
5.	A bateria encontra-se totalmente carregada, quando a luz avisadora verde começar a piscar.
	Recomenda-se o refrescamento das baterias de NiCd e NiMH duas ou três vezes, quando a sua capacidade mostrar uma deterioração apreciável.
	Para baterias de íões de Li é suficiente um ciclo de descarga e de carga. Recomenda-se que o processo seja efectuado, quando a capacidade da bateria indicada pelo carregador ou por um instrumento Leica Geosystems se desviar significativamente da capacidade nominal da bateria.



2.6

Luzes avisadoras





Significado dos símbolos

Símbolo	Significado
	LED desligado (Off).
	LED aceso continuamente.
	LED a piscar.

Luzes avisadoras de operação

Símbolo	LED	Significado
	Off	O carregador não se encontra ligado à fonte de alimentação.
	Verde	O carregador encontra-se ligado à fonte de alimentação.

Luzes avisadoras de estado





Símbolo	LED	Significado
	Off	A bateria não foi reconhecida pelo carregador.
	Amarelo	A bateria foi reconhecida pelo carregador. O carregador encontra-se em modo de stand-by, por existirem duas baterias em carga ou em descarga.
	Verde	A bateria encontra-se agora em carga.
	Verde	A bateria encontra-se totalmente carregada e pode ser retirada do carregador.

Luzes avisadoras de carga e erro

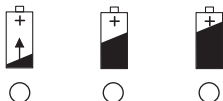
- Em funcionamento normal as 3 luzes avisadoras de capacidade e erro acendem de cor verde, indicando a capacidade da bateria no espaço de carga seleccionado. Após a selecção do espaço de carga, as luzes avisadoras acendem durante cerca de 10 segundos, apagando-se de seguida.
- Em caso de erro, as luzes avisadoras de capacidade e erro acendem de cor vermelha, indicando que foi detectada alguma anomalia no espaço de carga seleccionado.

Luzes avisadoras de capacidade











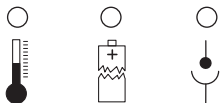



LEDs	Significado
	A carga da bateria é inferior a 20%.
	A carga da bateria é, pelo menos, de 20%.
	A carga da bateria é, pelo menos, de 50%.
	A carga da bateria é, pelo menos, de 80%.



Actualmente, o nível de carga é apenas apresentado para as baterias GEB211, GEB212, GEB221, GEB222, GEB241, GEB242 e GEB90 da Leica Geosystems.

Luzes avisadoras de erro



LEDs	Significado	Medidas a tomar
  	A bateria está demasiado fria ou demasiado quente.	Consultar o capítulo "Gama de temperaturas" para mais informações.
  	A bateria encontra-se defeituosa.	Utilizar outra bateria.
  	Contacto com defeito na bateria ou no adaptador da bateria.	Verificar os contactos.
  	Defeito no circuito interno do carregador.	Contactar um Centro de Assistência Leica Geosystems.



Se o carregador indicar alguma anomalia, quando a bateria se encontra ligada:

- Ligar uma bateria diferente, para verificar se o defeito é da bateria ou do carregador.
- Em caso de persistência da anomalia, contactar um Centro de Assistência Leica Geosystems.



Em caso de defeito, verificar também:

- Se existe corrente na tomada ou no isqueiro do veículo.
- Se os cabos se encontram correctamente ligados e se não existem outros defeitos óbvios.
- Se a luz avisadora de funcionamento se encontra acesa com o adaptador de veículo (opcional) ligado.

2.7

Sugestões

Sugestões

- Para carregar as baterias até à sua capacidade máxima, as baterias NiCd e NiMH novas devem ser totalmente descarregadas e carregadas 3 a 5 vezes.
- Deixar descarregar as baterias no instrumento o mais possível. No caso de baterias NiCd, a descarga completa antes da carga ajuda a evitar o chamado “efeito de memória”, típico destas baterias.
- Se for utilizado um adaptador de isqueiro, manter sempre o motor do veículo em funcionamento, durante a carga das baterias.



Evitar as mudanças bruscas de temperatura ambiente durante a carga das baterias (por exemplo, evitar a incidência directa da luz solar sobre as baterias ou o carregador). As mudanças bruscas da temperatura ambiente pode provocar a brusca finalização do processo de carga, sem as baterias estarem totalmente carregadas.

3

Cuidados e transporte

3.1

Transporte

Expedição

Para o transporte do produto por via férrea, aérea ou marítima, utilizar sempre a embalagem completa original Leica Geosystems, um contentor de transporte apropriado e uma caixa de cartão, para proteger o aparelho contra os choques e vibrações.

3.2

Armazenamento

Produto

Observar os limites de temperatura durante o armazenamento do produto, especialmente durante o Verão, se o produto estiver no interior de um veículo. Consultar o capítulo "5 Características técnicas" para mais informações sobre os limites de temperatura.

3.3

Limpeza e secagem do produto

Produto

Limpar o produto apenas com um pano macio e limpo.

Cabos e fichas

Manter os cabos e as fichas limpos e isentos de humidade. Limpar com ar comprimido a sujidade alojada nas fichas dos cabos.

4

Instruções de Segurança

4.1

Informações gerais

Descrição

As instruções seguintes destinam-se a informar a pessoa responsável pela unidade GKL 221 e a pessoa que utiliza o produto sobre os riscos inerentes à sua operação e ao modo de os evitar. A pessoa responsável pelo produto deve verificar se todos os utilizadores compreendem claramente estas instruções e controlar o seu estrito cumprimento.

4.2

Finalidade

Utilização correcta

- Carga e descarga de baterias de diversas tecnologias.
-

Utilização incorrecta

- Utilização do instrumento sem instruções de uso
 - Utilização fora dos limites correctos de utilização
 - Desactivação dos sistemas de segurança
 - Remoção dos avisos de segurança
 - Abertura do instrumento com ferramentas (chave de fendas, etc.), excepto quando autorizado por determinadas funções
 - Modificação ou alteração das características do carregador
 - Utilização após roubo
 - Utilização do produto obviamente danificado ou defeituoso
 - Utilização com acessórios de outros fabricantes, sem autorização expressa da Leica Geosystems
-

Atenção

A utilização incorrecta do aparelho pode conduzir a lesões corporais, avarias e danos materiais. Compete à pessoa responsável pelo produto informar os utilizadores sobre os riscos da sua utilização e as respectivas medidas correctivas. O produto não deverá ser utilizado até o utilizador ter sido devidamente instruído sobre o modo correcto da sua utilização.

4.3

Limites da utilização

Condições ambientais

Adequado para utilização exclusiva em ambientes secos e não sob condições adversas

4.4

Áreas de responsabilidade

Fabricante

A Leica Geosystems AG, com endereço em CH-9435 Heerbrugg (Suíça), adiante designada “Leica Geosystems”, é responsável pelo fornecimento do produto, incluindo o manual de operação e os acessórios originais, em condições de segurança adequadas.

Outros fabricantes

Os fabricantes de acessórios não Leica Geosystems são responsáveis pelo desenvolvimento, implementação e comunicação dos conceitos sobre os seus produtos em condições de segurança, e pela eficácia e adequação de tais conceitos com o produto da Leica Geosystems.

Pessoa responsável pelo produto

As responsabilidades do pessoal responsável pelo produto são as seguintes:

- Compreender as instruções de segurança do produto e as instruções constantes do Manual de Operação.
- Familiarização com os regulamentos locais sobre a prevenção de acidentes.
- Informar imediatamente a Leica Geosystems, em caso de falta de segurança do instrumento.

Atenção

A pessoa responsável pelo produto deve assegurar que a sua utilização é efectuada de acordo com as respectivas instruções de utilização. Esta pessoa é também responsável pela formação do pessoal utilizador do instrumento e pela segurança deste, durante a sua utilização.

4.5

Riscos da utilização

Atenção

A ausência de instruções adequadas, ou a instrução inadequada dos utilizadores, pode conduzir a utilizações incorrectas e a acidentes com consequências graves em termos humanos, materiais, financeiros e ambientais.

Precauções:

Todos os utilizadores do instrumento devem seguir as instruções do fabricante e da pessoa responsável pelo instrumento.

Atenção

O carregador não deve ser utilizado em ambientes ou locais húmidos ou com condições agressivas. A presença de humidade no aparelho pode provocar um choque eléctrico.

Precauções:

Utilizar o carregador apenas em espaços cobertos, secos e devidamente protegido contra a humidade. Não utilizar o carregador/adaptador se estiver molhado ou húmido.

Atenção

Em caso de abertura do carregador, o choque eléctrico pode ser provocado pelas seguintes situações:

- Contacto com componentes em tensão
- Utilização dos instrumentos e acessórios, após a reparação não autorizada.

Precauções:

Não abrir o carregador. A reparação destes produtos deve apenas ser efectuada por Centros de Assistência Leica Geosystems.

Atenção

As baterias não recomendadas pela Leica Geosystems podem ser danificadas e serem carregadas ou descarregadas pelo carregador. Nestas condições, as baterias podem inflamar-se ou explodir.

Precauções:

Utilizar com o carregador apenas as baterias recomendadas pela Leica Geosystems.

Atenção

A eliminação incorrecta do produto pode conduzir às seguintes ocorrências:

- A combustão dos componentes de polímeros pode libertar gases venenosos, nocivos para a saúde humana.
- Explosão das baterias, devido a aquecimento intenso, conduzindo a envenenamento, queimaduras, corrosão ou contaminação do ambiente.
- A eliminação final do produto de modo irresponsável pode permitir o seu acesso por pessoas não autorizadas e à sua utilização abusiva em termos dos regulamentos em vigor, com risco de exposição dos próprios e de terceiros e o risco de lesões corporais graves e de contaminação do ambiente.

Precauções:



O instrumento não deve ser misturado com os resíduos domésticos.

Eliminar o produto de modo apropriado, de acordo com os regulamentos em vigor no país de utilização.

Impedir sempre a utilização do instrumento por pessoas não autorizadas.

O tratamento específico para o produto e as informações sobre a gestão de resíduos podem ser descarregados do sítio da Leica Geosystems em <http://www.leicageosystems.com/treatment> ou solicitados a qualquer Distribuidor Leica Geosystems.

4.6

Compatibilidade electromagnética

Descrição

O termo “compatibilidade electromagnética” refere-se à capacidade de o instrumento funcionar correctamente em ambientes que existam radiações electromagnéticas e descargas electrostáticas, sem provocar perturbações magnéticas em outro equipamento.

Atenção

A radiação electromagnética pode provocar perturbações em outro equipamento.

Apesar de este carregador satisfazer integralmente os mais estritos regulamentos e normas em vigor, a Leica Geosystems não pode excluir completamente a possibilidade de interferência em outros equipamentos.



Aviso

Este carregador pode provocar a falha de outro equipamento, se for utilizado com componentes de outros fabricantes, i.e., cabos e baterias externas de outros fabricantes.

Precauções:

Utilizar apenas o equipamento e acessórios recomendados pela Leica Geosystems. Quando utilizados com o produto, os equipamentos e acessórios recomendados satisfazem as mais estritas normas e regulamentos.



Atenção

A utilização do produto com cabos (por exemplo, cabos de bateria) ligados apenas numa das extremidades, pode conduzir a que a radiação electromagnética exceda o nível admissível e provocar interferências em outros equipamentos.

Precauções:

Desligar ambas as extremidades do cabo, sempre que o produto não estiver a ser utilizado.

4.7

Referência FCC, Válida para os EUA



Atenção

Os testes realizados a este instrumento revelaram a sua compatibilidade com os limites referentes a dispositivos digitais da Classe B, nos termos da parte 15 dos Regulamentos FCC. Estes limites foram definidos para conferir um grau de protecção adequado contra as interferências nocivas em instalações domésticas.

Este equipamento gera, utiliza e pode irradiar energia de radiofrequências, caso não seja instalado de acordo com as instruções emitidas pelo fabricante, e pode provocar interferências nocivas para as comunicações via rádio.

Se o equipamento provocar interferências nocivas na recepção de sinais de rádio ou de televisão, o que pode ser determinado pela ligação e desligação do equipamento, o utilizador deverá tentar corrigir a interferência, através de uma ou mais das medidas seguintes:

- Reorientar ou deslocar a antena de recepção
- Aumentar o afastamento entre o equipamento e o receptor
- Ligar o equipamento a uma tomada ou circuito diferente do que alimenta do receptor
- Consultar um concessionário ou técnico especializado em equipamento de rádio e TV

Atenção

As alterações ou modificações funcionais não aprovadas expressamente pela Leica Geosystems podem cancelar a autoridade do utilizador para utilizar o equipamento.

Etiquetas

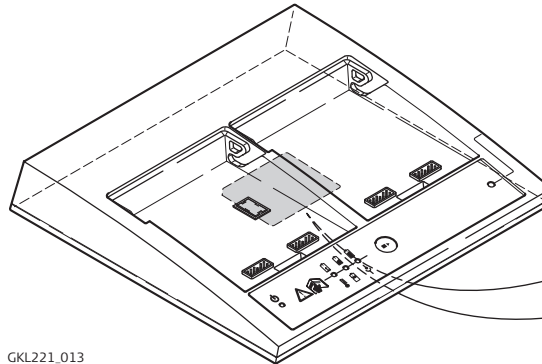

GKL221_013

Type: GKL221

Art.No.:

.....
.....
.....
.....
.....
.....

This device complies with part 15 of the FCC Rules. Operation is subject to the following two conditions: (1) This device may not cause harmful interference, and (2) this device must accept any interference received, including interference that may cause undesired operation.

PT

5

Características técnicas

Alimentação eléctrica	<ul style="list-style-type: none">• Ligação à rede eléctrica (corrente alternada)• Ligação a corrente contínua, ==
Tensão de alimentação	<ul style="list-style-type: none">• 100 - 240 V AC, 50/60 Hz• 24 V DC
Potência de carga	Máximo 18 V DC / máximo 4,0 A; conforme o tipo de bateria
Descarga	4 W
Potência nominal	~ : 75 W == : 55 W
Condições ambientais	Utilizar apenas em ambientes secos, como, por exemplo, em espaços cobertos ou no interior de veículos automóveis. Classe de protecção IP40, conforme norma IEC 60529
Gama de temperaturas	Em armazena- -40°C a +70°C -40°F a +158°F mento: Operação: ~ : 0°C a +40°C +32°F a 104°F == : 0°C a +50°C +32°F a 122°F
Modos de carregamento	Carregamento rápido para: <ul style="list-style-type: none">• Todas as baterias Leica Geosystems. Com controlo da temperatura e reconhecimento do tipo de bateria. Corrente de carga máxima de 4,0 A, conforme a bateria.• Todas as baterias tipo gravador de vídeo standard com 3 superfícies de contacto e controlo de temperatura. Corrente de carga máxima de 1,6 A

Carregamento normal para:

- Baterias NiCd e NiMH, em temperaturas inferiores a +10°C.
- Baterias de íões de Li, em temperaturas inferiores a +6°C.
- Baterias de Li-Ion, NiCd e NiMH totalmente ou parcialmente descarregadas.

Carregamento de conservação para:

- Baterias NiCd e NiMH. A corrente de carga depende do tipo de bateria. O carregamento é efectuado em ciclos de cerca de 15 segundos por cada bateria.



As baterias de íões de Li não necessitam de carregamento de conservação, já que estas baterias não perdem a carga quando não são utilizadas.

Tecnologia de carga

Condições de desligação no modo de carregamento rápido:

Baterias NiCd e NiMH:

Temporizador
Capacidade
Temperatura da bateria
Diferença de tensão negativa
Aumento de temperatura por minuto
Método de inflexão dupla

Baterias de íões de Li:

Temporizador
Capacidade
Temperatura da bateria
Corrente de carga

PT

Tipo de elemento

Carga de conservação para NiCd e NiMH:

Controla a tensão da bateria, a corrente de carga e a temperatura da bateria.

- NiCd
- NiMH
- Íões de Li

Durações das cargas e descargas

As durações das cargas e descargas dependem primariamente da corrente de carga e descarga, da capacidade da bateria e do estado da carga no momento da ligação.

Podem ser fornecidas as seguintes linhas de orientação:

Carregamento rápido a 20°C:

Baterias NiCd

máx. 2200 mA.h 1,0 a 1,5 h

máx. 7200 mA.h 2,5 a 4,0 h

Baterias NiMH

máx. 2200 mA.h 1,5 a 2,0 h

máx. 4900 mA.h 2,0 a 2,5 h

máx. 10000 mA.h 2,5 a 5,5 h

Baterias de iões de Li

máx. 4600 mA.h 2,5 a 3,5 h

Descarga:

Baterias NiCd e NiMH:

Baterias de 6 V com 600 mA.h por hora

Baterias de 12 V com 300 mA.h por hora

Baterias de iões de Li

Baterias de 7,4 V com 500 mA.h por hora

Indicação

Consultar o capítulo "2.6 Luzes avisadoras".

Peso

Carregador incluindo dois adaptadores de baterias: 1,12 kg

Dimensões

C X L X A: máximo 237 mm x 227 mm x 43 mm; incluindo o adaptador da bateria

Leica GKL221 ladestation

Brugervejledning

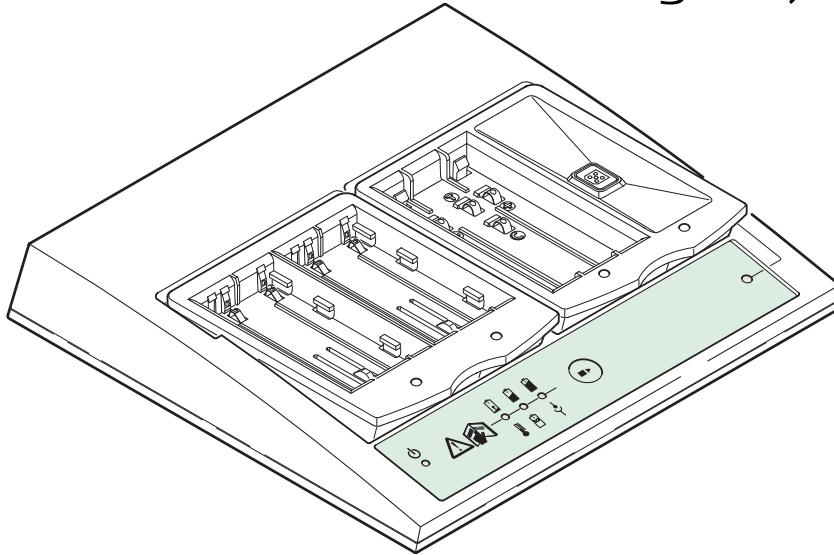

DA

Version 1.3
Dansk

- when it has to be **right**

Leica
Geosystems

Introduktion



Ud over vejledning i brug, indeholder brugervejledningen også vigtige sikkerhedsanvisninger. Se afsnit "4 Sikkerhedsanvisninger". Læs brugervejledningen grundigt, før produktet anvendes.

Produktidentifikation





Model og serienummer er trykt på produktets navneplade. Notér dem i brugervejledningen og angiv dem hver gang du kontakter et Leica Geosystems autoriseret værksted vedrørende produktet.

Model: _____

Serienr.: _____

Anvendte symboler

De anvendte symboler i denne brugervejledning har følgende betydning:

Symbol	Betydning
 Fare	Angiver en farlig situation med overhængende fare for alvorlige personskader eller død.
 Advarsel	Fare ved brug eller anvendelse i strid med anvisningerne, som kan føre til alvorlige personskader eller død.
 Udvis forsigtighed	Fare ved brug eller anvendelse i strid med anvisninger, som kun kan føre til mindre personskader, men til betydelige materielle, økonomiske eller miljømæssige skader.
	Brugsinformation, som hjælper brugeren til at benytte produktet på en teknisk korrekt og effektiv måde.

Indholdsfortegnelse

Indhold	Emne	Side
1	Systembeskrivelse	4
2	Betjening	8
	2.1 Batteriadapter	8
	2.2 Tilslutning af ladeaggregatet	9
	2.3 Isætning og aftagning af batterierne	11
	2.4 Valg-knap	14
	2.5 Opladning af batteriet	15
	2.6 Indikatorer	17
	2.7 Tips	20
3	Opbevaring og transport	21
	3.1 Transport	21
	3.2 Opbevaring	21
	3.3 Rengøring og tørring	21
4	Sikkerhedsanvisninger	22
	4.1 Generel information	22
	4.2 Anvendelsesformål	22
	4.3 Begrænsninger for anvendelse	23
	4.4 Ansvarsområder	23
	4.5 Risici ved anvendelse	23
	4.6 Elektromagnetisk kompatibilitet	25
	4.7 FCC Reference, gældende i USA	26
5	Tekniske Data	28

1

Systembeskrivelse

Beskrivelse

Leica Geosystems GKL221 er et intelligent ladeaggregat med avanceret ladeteknologi. Det er designet til at oplade alle Leica batterier. Som strømforsyning kan anvendes både lysnettet og GDC221 adapter tilsluttet cigarettænderen i køretøjer. GKL221 er et meget nyttigt supplement til dine batteridrevne produkter fra Leica Geosystems.

Generel information

Der kan tilsluttes op til fem batterier i ladeaggregatet. To batterier kan oplades på samme tid. Når mere end to batterier er tilsluttet, lades resten i den rækkefølge de blev tilsluttet. Ud over opladning kan ladeaggregatet også aflade og genopfriske batterier.



Vi anbefaler, at enheden startes op nu, mens resten af brugervejledningen læses.

Systemenheder

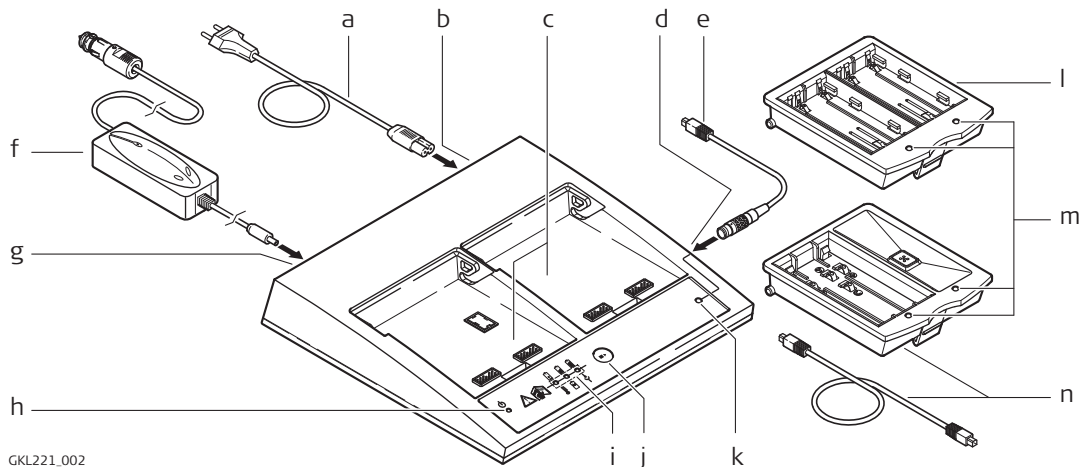

GKL221_002

- a) Strømkabel, specifikt for det relevante land
- b) Stik til strømkabel på ladeaggregatet
- c) Adaptertilslutninger I og II til GDI221 / GDI222 batteriadaptere
- d) Tilslutning af kabel til eksternt batteri
- e) Kabelstik til eksterne 5-pols batterier
- f) Køretøjsadapter GDC221, ekstra tilbehør
- g) Køretøjskabelstik på ladeaggregatet
- h) Funktionsindikator
- i) Kapacitets- og fejlindikatorer
- j) Valgknop til at foretage valg
- k) Statusindikator for eksternt batteritilslutning
- l) GDI221 batteriadapter, ekstra tilbehør
- m) Batteristatus-indikatorer
- n) GDI222 batteriadapter og 5-pols ladekabel, ekstra tilbehør

Genopladelige batterier

Følgende Leica Geosystems batterier kan oplades:

GEB90
GEB211
GEB212
GEB221
GEB222
GEB241
GEB242



GEB111
GEB121

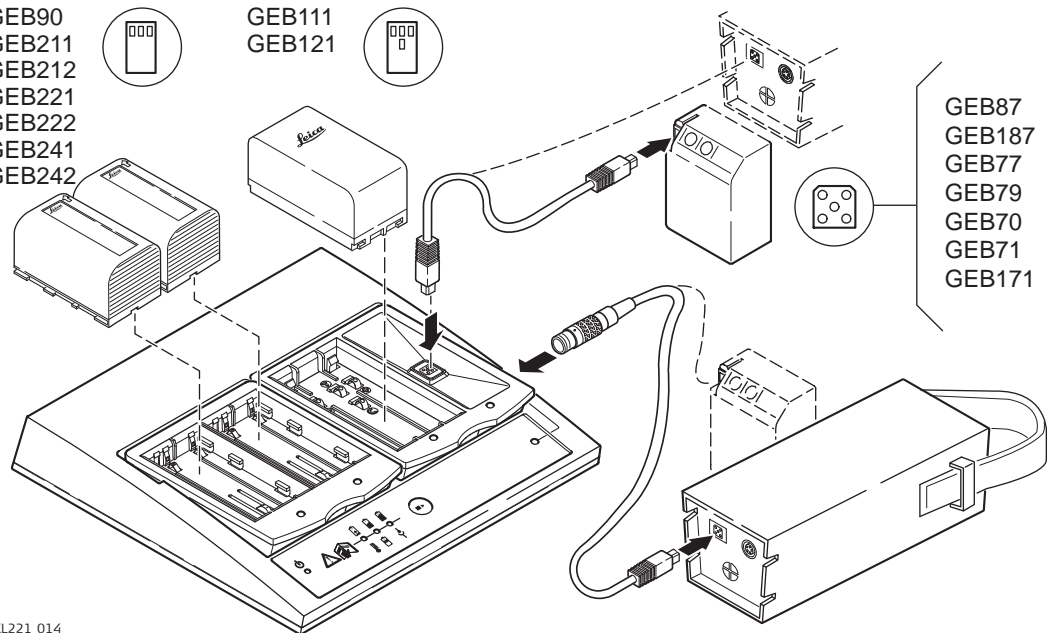

GEB87
GEB187
GEB77
GEB79
GEB70
GEB71
GEB171

GKL221_014



Ladeaggregatet er designet til at genoplade og aflade originale Leica batterier og også nogle NiMH/ NiCd videokamera-batterier. Se afsnit "2.3 Isætning og aftagning af batterierne".

Adaptore til oplader og batterier

Brug af ladeaggregatet i kombination med batteriadapterne giver mulighed for tilslutning af følgende batterier til ladeaggregatet:

Adaptore til oplader og batterier	Genopladelige batterier
GKL221 med to GDI221	Op til fire Li-ion batterier og ét batteri med et 5-pols-stik.
GKL221 med en GDI221 og en GDI222	Op til to Li-ion batterier, ét videokamerabatteri og to batterier med 5-pols-stik.
GKL221 med to GDI222	Op til to videokamerabatterier og tre batterier med 5-pols-stik.

2

2.1

Betjening

Batteriadapter

Anvendelsesformål

Batteriadapteren forbinder ladeaggregatet med de tilsvarende batterier og har for hver opladningsplads til batterier én LED som angiver batteriets status.

Type

Der findes følgende batteriadaptere:

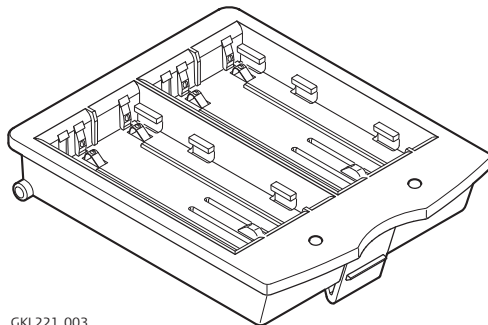

GKL221_003

GDI221

- Til to Leica Geosystems Li-ion batterier GEB90, GEB211, GEB212, GEB221, GEB222, GEB241 eller GEB242.

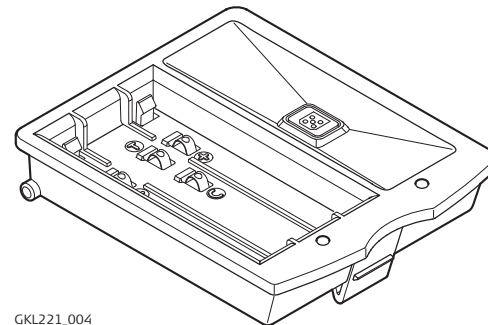

GKL221_004

GDI222

- Til ét Leica Geosystems NiMH batteri GEB111 eller GEB121 og ét NiCd eller NiMH 5-pols batteri.

Isætning og aftagning

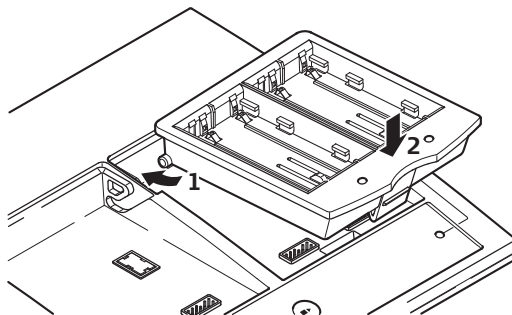

GKL221_005

Isætning

1. Isæt batteriadapteren langs den bagerste styrende kant.
2. Tryk på batteriadapterens front til den klikker på plads.

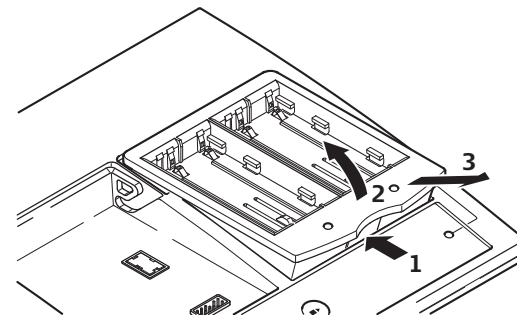

GKL221_006

Aftagning

1. Tryk på batteriadapterens front for at åbne den.
2. Løft det forsigtigt op til det stopper.
3. Fjern adapteren ved at trække den frem.

DA

2.2

Tilslutning af ladeaggregatet

Advarsel

Opstart

Brug kun ladeaggregatet i tørre rum! Brug aldrig ladeaggregatet, når det er vådt eller fugtigt!

Stil altid ladeaggregatet på et stabilt underlag, inden det startes.

Tilslut ladeaggregatet enten:

- Med det medfølgende kabel til stikkontakt eller
- Med GDC211 køretøjsadapter (ekstra tilbehør) til køretøjets batteri



Tag stikket ud af stikkontakten eller fra køretøjets strømforsyningsstik, hvis ladeaggregatet ikke bruges i længere tid.



Brug kun køretøjsadapteren til strømforsyning i køretøj. Hvis strømmen kommer fra andre kilder, som f.eks. transformatorer, kan fejl opstå. Se afsnit "5 Tekniske Data" om spænding og angivet effekt.



Ved ældre køretøjer kontrolleres at + polen er i den midterste kontaktoverflade i cigarettænderen. Skulle polariseringen være forkert, vil sikringen i ladeaggregatet eller sikringen i køretøjsadapteren skulle skiftes. Sikringen i ladeaggregatet skal skiftes af et autoriseret Leica Geosystems serviceværksted. Sikringen i køretøjsadapteren skal skiftes som beskrevet i adapterens brugervejledning.

Funktionstjek

Efter at adapteren er tilsluttet til stikkontakten eller til strømforsyning i køretøj, lyser rød, gul og grøn funktionsindikator op én gang og kapacitets- og fejl-indikatorerne lyser rødt og grønt. Dette er et funktionstjek.

Hvis der ikke er sat batteri i, vil kun den grønne funktionsindikator lyse.

Hvis statusindikatoren og de tre kapacitets- og fejl-indikatorer tændes og forbliver røde, er der fundet en fejl. Se afsnit "2.6 Indikatorer" for mere information.

2.3

Isætning og aftagning af batterierne

Li-Ion batterier

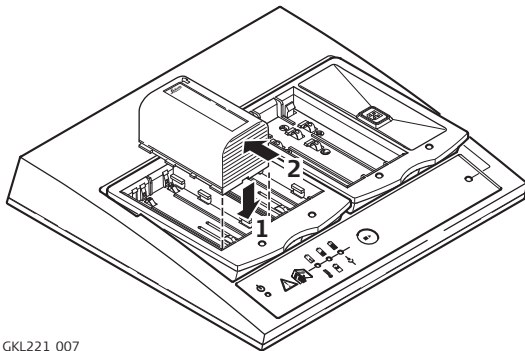

GKL221_007

Isætning:

1. Isæt batteriet mod forkanten af GDI221 batteritilslutningen.
2. Skub batteriet nedad med et svagt tryk indtil det ikke kan komme længere.

Aftagning:

- Skub batteriet bagud til det stopper og tag det ud.



Op- og aflad kun batterier anbefalet af Leica Geosystems. Brug kun Leica Geosystems Li-ion batterier.

DA

NiCd og NiMH Batterier

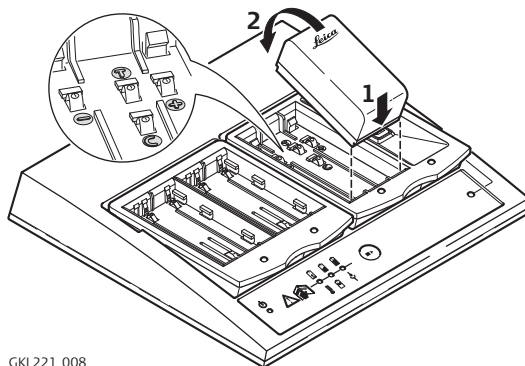

GKL221_008

Isætning:

1. Isæt batteriet mod forkanten af GDI221 batteritilslutningen.
2. Skub batteriet nedad indtil det klikker på plads.

Aftagning:

- Skub batteriet bagud og fjern det.

DA



Leica Geosystems GEB111 og GEB121 batterier har fire kontaktflader, hvor batterier til videokameraer lavet af andre kun har tre. Ladeaggregatet kan skelne mellem disse to typer batterier og indstille ladeprocessen herefter.



Batterier med tre kontaktflader skal leve op til følgende specifikationer for at undgå beskadigelse:

- Spænding: 6 V
- Batteritype: NiCd eller NiMH
- Minimumskapacitet: NiCd 1500 mAt, NiMH 1800 mAt
- Kompatible kontakter i den rigtige rækkefølge, f.eks. "+, T, -" på linie.

Videokamerabatterier som lever op til disse krav, monitoreres for temperatur og lades med en strøm på 1,6 A.

Batterier med 5-pols opladningsstik

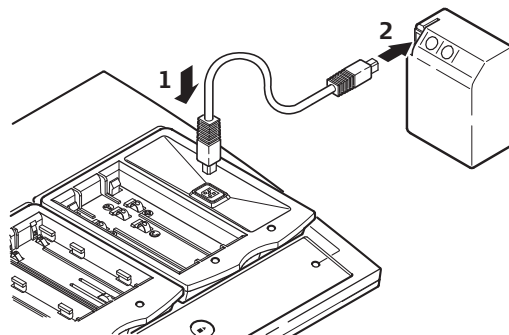

GKL221_009

Leica Geosystems batterier med 5-pols opladningsstik, f.eks. GEB87 eller GEB70, skal tilsluttes til ladekablets 5 pins strømforsyningsstik.

Eksterne batterier med 5-pols opladningsstik

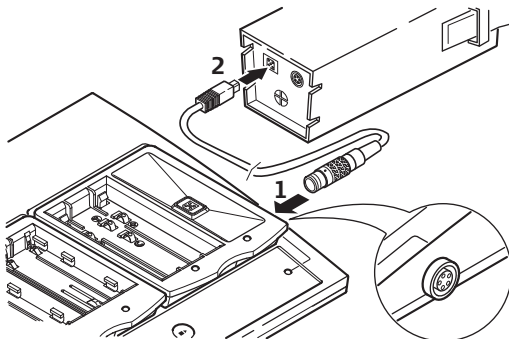

GKL221_010

Leica Geosystems batterier med 5-pols opladningsstik, f.eks. GEB87 eller GEB70, skal tilsluttes til ladekablets stik til ekstern batteritilslutning.

👉 Batterier på stik til ekstern batteritilslutning kan oplades uden at afbryde en ladeproces, der allerede er igang.

DA

2.4

Valg-knap

Funktioner

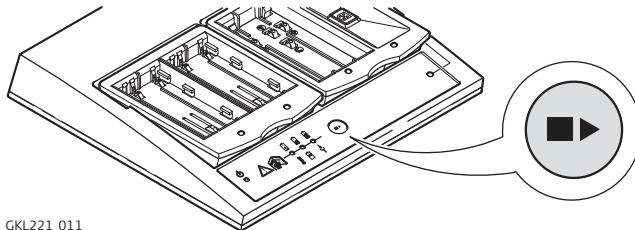

GKL221_011

Valgknappen bruges til at vælge en batteritilslutning og til at skifte mellem lade- og aflade-tilstand.

Funktioner	Tryk på valg-knappen	Beskrivelse
Valg af batteritilslutning	Mindre end to sekunder	Den næste batteritilslutning med et batteri vælges. Den valgte batteritilslutning indikeres af den gule statusindikator, som blinker hurtigt i omkring tre sekunder; batterikapaciteten vises også
Skift mellem op og af-ladningstilstand	Mere end tre sekunder	Skift til afladetilstand får statusindikatoren til at blinke gult-rød i omkring fem sekunder, mens skift til opladetilstand får statusindikatoren til at blinke gult-grønt i omkring fem sekunder.



Afladning indikeres af den blinkende røde statusindikator. Når afladningsprocessen er færdig, begynder den grønne indikator at blinke, for at indikere at batteriet er opladet.

2.5

Opladning af batteriet

Procedure

Trin	Beskrivelse
1.	Isæt batteriadapteren.
2.	Tilslut ladeaggregatet til strømforsyning, og den grønne funktionsindikator lyser.
3.	Isæt batteriet. Den gule statusindikator blinker for at indikere, at batteriet er detekteret.
4.	Hold øje med, at den grønne statusindikator forbliver tændt. Batteriet oplades nu. Se afsnit "Indikatorer", hvis andre statusindikatorer tændes, når batteriet er tilsluttet.  Tjek statusindikatoren efter omkring ét minut.
5.	Batteriet er fuldt opladet, når den grønne statusindikator begynder at blinke. Se afsnit "Tekniske Data", for information om opladningstider.
6.	Batteriet kan fjernes eller forblive tilsluttet for at sikre, at det er fuldt opladet, når der er behov for det. Se afsnit "Opladningstilstande".

Opsætning af ladeforløb

GKL221 opladeren kan oplade to batterier samtidigt. Sluttes mere end ét batteri til ladeaggregatet, lades de op i den rækkefølge, de bliver tilsluttet. Tilslut derfor først det batteri, som du har mest brug for bliver ladet op først.

Prioriteringer



Batterier oplades på eksterne batteritilslutning, uden at forstyrre en allerede påbegyndt ladeprocess.

Opretholde fuld opladning

Når batteriet er fuldt opladet, kan det forblive tilsluttet. NiCd og NiMH batterier lades på skift for at opretholde deres fulde opladning. På denne måde kompenseres for indre selvafladning og batteriet er altid fuldt opladet og klart til brug. Se afsnit "Opladningstilstande".

Genopfriskning af batteriet



Genopfriskningsfunktionen aflader batteriet helt og sætter det derefter på hurtigopladning.

Trin	Beskrivelse
1.	Tilslut ladeaggregatet til strømforsyningen.
2.	Isæt batteriet. Den gule statusindikator blinker for at indikere, at batteriet er detekteret.
3.	Tryk på valgknappen i mere end tre sekunder for at starte processen med afladning af batteriet. Afladning vises ved at den røde statusindikator blinker.  Afladning kan tage længere tid for batterier med stor kapacitet. For at holde afladningstiderne lave, kan man benytte denne funktion med batterier, som i forvejen er helt eller delvist afladede.
4.	Når batteriet er afladet, sættes det på hurtig opladning. Statusindikatoren lyser grønt .
5.	Batteriet er fuldt opladet, når den grønne statusindikator begynder at blinke.
	Vi anbefaler genopfriskning af NiCd og NiMH batterier to eller tre gange, når deres kapacitet begynder at falde mærkbart.
	For Li-ion batterier er en enkelt af- og opladningsrunde tilstrækkeligt. Vi anbefaler at udføre processen, når batteriets kapacitetsindikator på laderen eller på et Leica Geosystems produkt afviger markant fra den reelle tilgængelige batterikapacitet.



2.6

Indikatorer





Forklaring af symbolerne

Symbol	Betydning
	LED slukket.
	LED tændt konstant.
	LED blinker.



Betjeningsindikatorer

Symbol	LED	Betydning
	Slukket	Ladeaggregatet er ikke tilsluttet til strømforsyningen.
	Grøn	Ladeaggregatet er tilsluttet til strømforsyningen.

Statusindikatorer

Symbol	LED	Betydning
	Slukket	Det tilsluttede batteri blev ikke detekteret.
	Gul	Det tilsluttede batteri blev detekteret. Ladeaggregatet er i stand-by mode, da to andre batterier op- eller aflades.
	Grøn	Det tilsluttede batteri oplades nu.
	Grøn	Det tilsluttede batteri er fuldt opladet og kan fjernes.
	Rød	Ladeaggregatet har opdaget en fejl.

DA





Symbol	LED	Betydning
	Rød	Et batteri til genopfriskning er tilsluttet. Batteriet aflades.
	Gul	Indikerer den aktive, valgte batteritilslutning.

Kapacitets- og fejl-indikatorer

- Ved normalt brug lyser de tre kapacitets- og fejl-indikatorer grønt for at indikere kapaciteten af batteriet i den valgte batteritilslutning. Efter valg af batteritilslutning lyser indikatorerne i omkring 15 sekunder, derefter slukkes de.
- I tilfælde af fejl vil kapacitets- og fejl-indikatorerne skifte til rødt for at indikere, at der er en fejl i den valgte batteritilslutning.

Kapacitetsindikatorer









LED'ere	Betydning
	Batteriets opladning er mindre end 20%.
	Batteriets opladning er mindst 20%.
	Batteriets opladning er mindst 50%.
	Batteriets opladning er mindst 80%.

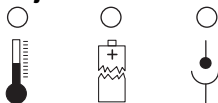

På nuværende tidspunkt kan niveauet for ladning kun vises for Leica Geosystems GEB211, GEB212, GEB221, GEB222, GEB241, GEB242 og GEB90 batterier.

Fejlindikatorer



LED'ere	Betydning	Løsningsmuligheder
 ○ ○	Batteriet er for koldt eller overophedet.	Se afsnit "Temperaturområde".
○  ○	Batteriet er defekt.	Brug et andet batteri.
○ ○ 	Defekt kontakt med batteriet eller batteri-adapter.	Tjek kontakten.
  	Hardware-fejl i ladeaggregatet.	Kontakt et autoriseret Leica Geosystems serviceværksted.



Hvis ladeaggregatet indikerer fejl, når batteriet er tilsluttet:

- Tilslut et andet batteri for at tjekke om fejlen skyldes batteriet eller ladeaggregatet.
- Hvis problemet fortsætter, kontaktes et autoriseret Leica Geosystems serviceværksted.



I tilfælde af fejl tjekkes også:

- Om der er strøm i stikkontakten eller køretøjets strøm kredsløb.
- Om alle kablerne er korrekt tilsluttet og om der kan findes nogen iøjnefaldende fejl.
- Om funktionsindikatoren er tændt på evt. tilsluttet køretøjsadapter.

2.7

Tips

Tips

- For at oplade batterier til deres fulde kapacitet, bør nye NiCd og NiMH batterier af- og oplades helt 3 til 5 gange.
 - Lad batterierne i instrumentet aflade så meget som muligt. Det forebygger den såkaldt "memoryeffekt" med NiCd batterier.
 - Når der bruges en køretøjsadapter, bør motoren altid holdes i gang, når batterierne oplades.
-



Undgå hurtige ændringer i den omgivende temperatur, når batterierne oplades (lad f.eks. ikke solen skinne direkte på batterierne eller på ladeaggregatet). Hurtige ændringer i den omgivende temperatur kan få ladeprocessen til at stoppe for tidligt, uden at have opladet batterierne helt.

3

Opbevaring og transport

3.1

Transport

Forsendelse

Ved transport af produktet med tog, fly eller skib bør man altid benytte den komplette, originale Leica Geosystems emballage, transportcontainer og kasse, eller tilsvarende, for at beskytte mod stød og vibrationer.

3.2

Opbevaring

Produkt

Overhold temperaturgrænserne ved opbevaring af produktet, især om sommeren hvis produktet er i et køretøj. Se afsnit "5 Tekniske Data" om temperaturgrænserne.

3.3

Rengøring og tørring

Produkt

Produktet aftørres altid med en blød og ren klud.

Kabler og stik

Hold stik rene og tørre. Skidt i kablernes stik blæses væk.

4

Sikkerhedsanvisninger

4.1

Generel information

Beskrivelse

De følgende anvisninger skal gøre personen med ansvaret for GKL221 og brugeren i stand til at forudse og udgå farer ved brug.

Personen med ansvar for produktet skal sikre, at alle brugere forstår og overholder disse anvisninger.

4.2

Anvendelsesformål

Tilladt brug

- Op- og afladning af diverse celleteknologier.
-

Ukorrekt brug

- Anvendelse af produktet uden instruktion
- Anvendelse af produktet udenfor de fastsatte grænser
- Frakobling af sikkerhedssystemet
- Fjernelse af advarselsmærkater
- Åbning af produktet med værktøj (skruetrækker etc.), undtagen når dette udtrykkeligt tillades i bestemte situationer
- Ændring eller ombygning af instrumentet
- Anvendelse efter uretmæssig tilegnelse
- Brug af produkter med tydelige skader eller fejl
- Brug af tilbehør af andet fabrikat uden Leica Geosystems udtrykkelige godkendelse

Advarsel

Ukorrekt anvendelse kan føre til personskade, fejlfunktion og materiel skade. Den person, som er ansvarlig for produktet, skal informere brugeren om risici ved brugen af udstyret og hvordan disse undgås.

Produktet må ikke tages i brug, før brugeren er blevet instrueret i den korrekte brug af det.

4.3

Begrænsninger for anvendelse

Omgivelser

Må kun anvendes i tørre omgivelser og ikke under mere barske forhold

4.4

Ansvarsområder

Producenten

Leica Geosystems AG, CH-9435 Heerbrugg, herefter kaldet Leica Geosystems, er ansvarlig for at levere produktet, inklusiv brugervejledning og originalt tilbehør, i komplet sikker tilstand.

Tredieparts producenter

Producenterne af ikke-Leica Geosystems tilbehør er ansvarlige for udvikling, indførelse og formidling af sikkerhedskoncepter for deres produkter og er også ansvarlige for effekten af disse sikkerhedskoncepter i kombination med Leica Geosystems produktet.

Person med ansvar for produktet

Den person, som er ansvarlig for instrumentet, har følgende forpligtelser:

- At forstå sikkerhedsanvisningerne på produktet og anvisningerne i brugervejledningen
 - At være bekendt med gældende regler med hensyn til sikkerhed og forebyggelse af ulykker.
 - At informere Leica Geosystems straks, hvis produktet bliver usikkert.
-

Advarsel

Personen med ansvar for produktet skal sikre, at det bruges i overensstemmelse med anvisningerne. Denne person er også ansvarlig for træning og informering af medarbejderne, som bruger produktet, og for sikkerheden ved brug af produktet.

4.5

Risici ved anvendelse

Advarsel

Manglende eller ufuldstændig instruktion kan føre til fejlbetjening eller ukorrekt anvendelse. Derved kan der ske ulykker med alvorlige følger for personer, ting, økonomi og miljøet

Modforholdsregler:

Alle brugere skal følge producentens sikkerhedsanvisninger og anvisningerne givet af den person, der er ansvarlig for produktet.

 **Advarsel**

Ladeaggregatet må ikke anvendes i våde eller barske omgivelser. Hvis enheden bliver våd, kan du få et elektrisk stød.

Modforholdsregler:

Anvend kun ladeaggregatet i tørre omgivelser og beskyt det mod fugt. Et vådt ladeaggregat må ikke anvendes.

 **Advarsel**

Hvis du åbner ladeaggregatet, kan følgende ting forårsage, at du får elektrisk stød:

- Hvis der røres ved strømførende dele
- Anvendelse af ladeaggregatet efter et ukorrekt forsøg på reparation.

Modforholdsregler:

Åben aldrig laderen. Kun serviceværksteder autoriseret af Leica Geosystems må reparere disse produkter.

 **Advarsel**

Batterier, som ikke er anbefalet af Leica Geosystems, kan blive beskadiget ved op- eller afladning. De vil kunne brænde eller eksplodere.

Modforholdsregler:

Op- eller aflad kun batterier anbefalet af Leica Geosystems.

 **Advarsel**

Ved ukorrekt bortskaffelse af udstyret kan der ske følgende:

- Hvis polymere dele afbrændes kan der opstå giftige gasser, som kan være sygdomsfremkaldende.
- Hvis batterierne er beskadigede eller kraftigt ophedede, kan de eksplodere og forårsage forgiftning, forbrænding, korrosion eller forurening.

- Ved ukorrekt bortskaffelse giver du uberettigede personer mulighed for at anvende udstyret ukorrekt. Herved kan du og trediemand komme alvorligt tilskade og miljøet kan blive forurennet.

Modforholdsregler:

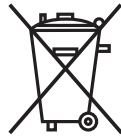

Produktet må ikke smides ud sammen med husholdningsaffald.
Sørg for at udstyret bortskaffes korrekt i overensstemmelse med de nationale miljøbestemmelser i dit land.
Sørg altid for at uautoriserede personer ikke får adgang til produktet.

Produkt-specifik information om håndtering og affaldshåndtering kan downloades på Leica Geosystems hjemmesiden på <http://www.leica-geosystems.com/treatment> eller modtages fra din Leica Geosystems forhandler.

4.6

Elektromagnetisk kompatibilitet

DA

Beskrivelse

Med begrebet "elektromagnetisk kompatibilitet" forstår vi evnen hos produktet til at fungere korrekt i et område med elektromagnetisk stråling og statisk elektricitet uden at forårsage elektromagnetiske forstyrrelser i andre instrumenter.

Advarsel

Elektromagnetisk stråling kan forårsage forstyrrelser i andre instrumenter

Selvom produktet opfylder de strenge krav og standarder, som gælder på dette område, kan Leica Geosystems ikke helt udelukke forstyrrelser af andre instrumenter.

Udvis forsigtighed

Det kan forårsage fejl i andet udstyr, hvis produktet bruges sammen med trediepartsenheder, som f.eks. tredieparts kabler eller eksterne batterier.

Modforholdsregler:

Brug kun udstyr eller tilbehør anbefalet af Leica Geosystems. Når de bruges sammen med produktet, opfylder de alle de strenge standarder og krav.

Advarsel

Brug af produktet med kabler (f.eks. batterikabler), der kun er stukket ind i den ene ende, kan få den elektromagnetiske stråling til at overskride det tilladte niveau og forstyrre andet udstyr.

Modforholdsregler:

Når produktet er i brug, skal begge ender af kabler være i.

4.7

FCC Reference, gældende i USA

Advarsel

Dette produkt har ved test overholdt de grænseværdier, som er fastsat i afsnit 15 i FCC-sestemmelserne for digitale apparater i klasse B.

Disse grænseværdier forudsætter for installation i boligområder en tilstrækkelig beskyttelse mod forstyrrende stråling.

Dette produkt frembringer, bruger og kan udstråle højfrekvent energi og kan, hvis det ikke er installeret og anvendt i overensstemmelse med anvisningerne, forårsage skadelig forstyrrelse af radiokommunikation.

Hvis produktet giver skadelig forstyrrelse af radio eller TV, hvilket kan afgøres ved at tænde og slukke produktet, bør brugeren forsøge af fjerne forstyrrelsen på eller flere af følgende måder:

- Drej eller flyt modtageantennen
 - Forøg afstanden mellem instrument og modtager
 - Tilslut instrumentet til stikket i en strømkreds, som er en anden end modtagerens
 - Kontakt Deres forhandler eller en erfaren radio- og TV-tekniker for yderligere hjælp.
-

Advarsel

Ændringer eller modifikationer, der ikke udtrykkeligt er blevet tilladt af Leica Geosystems, kan indskrænke brugerens rettigheder til at tage apparatet i brug.

Mærkater

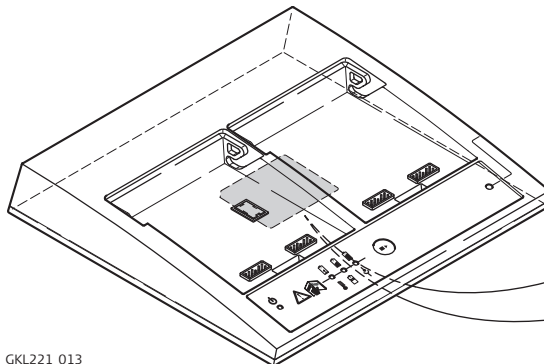

GKL221_013

Type: GKL221

Art.No.:

.....
.....
.....
.....
.....
.....
.....

This device complies with part 15 of the FCC Rules. Operation is subject to the following two conditions: (1) This device may not cause harmful interference, and (2) this device must accept any interference received, including interference that may cause undesired operation.

DA

5

Tekniske Data

Strømforsyning	<ul style="list-style-type: none">• Tilslutning til jævnstrømsspænding, ~• Vekselstrømsspændingstilslutning, ==
Input spænding	<ul style="list-style-type: none">• 100 - 240 V vekselstrøm, 50/60 Hz• 24 V jævnstrøm
Ladeeffekt	Maksimum 18 V jævnstrøm / maksimum 4,0 A; afhænger af batteritype
Afladning	4 W
Effektangivelse	~ : 75 W == : 55 W
Anvendelsesmiljø	Anvendes kun i tørre omgivelser, f.eks. i bygninger og køretøjer IP40, ifølge IEC60529
Temperaturområde	Opbevaring: -40°C til +70°C -40°F til +158°F Anvendelse: ~ : 0°C til +40°C +32°F til 104°F == : 0°C til +50°C +32°F til 122°F
Opladningstilstande	Hurtigopladnings -tilstand for: <ul style="list-style-type: none">• Alle Leica Geosystems batterier. Det foretager temperaturovervågning og batteridetektion. Ladestrømmen er maksimalt 4,0 A, afhængigt af batteriet.• Alle standard videokamerabatterier med tre kontaktflader og temperaturovervågning. Ladestrømmen er maksimalt 1,6 A Normal opladnings -tilstand for: <ul style="list-style-type: none">• NiCd og NiMH batterier ved temperaturer under +10°C.• Li-ion batterier ved temperaturer under +6°C• Helt eller næsten afladene Li-Ion, NiCd og NiMH batterier.



Ladeteknologi

Vedligeholdelsesladning for:

- NiCd og NiMH batterier. Ladestrømmen afhænger af batteritype. Opladning foregår på skift med omkring 15 sekunder pr. batteri.

Li-ion batterier kræver ikke vedligeholdelsesladning, da de ikke taber deres ladning, når de ikke bruges.

Forhold, hvor hurtigladning slår fra:

NiCd og NiMH batterier:

Timer
Kapacitet
Batteritemperatur
Negativ spændingsdifference
Temperaturforøgelse pr. minut
Dobbelt infleksionsmetode

Li-ion batterier:

Timer
Kapacitet
Batteritemperatur
Ladestrømstyrke

Vedligeholdelsesladning af NiCd og NiMH batterier:

Overvåger batterispænding, ladestrøm og batteritemperatur.

Celletype

- NiCd
 - NiMH
 - Li-ion
-

Tider for opladning og afladning

Tiderne for op- og afladning afhænger primært af ladestrømmen og afladningsstrømmen, kapaciteten for batteriet og tilstanden ladeaggregatet er i, når det er tilsluttet.

Der kan gives følgende guidelines:

Hurtigopladning ved 20°C:

NiCd batterier

max 2200 mAh 1,0 til 1,5 t

max 7200 mAh 2,5 til 4,0 t

NiMH batterier

max 2200 mAh 1,5 til 2,0 t

max 4900 mAh 2,0 til 2,5 t

max 10000 mAh 2,5 to 5,5 t

Li-Ion batterier

max 4600 mAh 2,5 til 3,5 t

Afladning:

NiCd og NiMH batterier

6V batterier med 600 mAh pr. time

12V batterier med 300 mAh pr. time

Li-ion batterier

7,4V batterier med 500 mAh pr. time

Indikatorer

Se afsnit "2.6 Indikatorer".

Vægt

Ladeaggregat inklusiv to batteriadaptere: 1,12 kg

Dimensioner

B X D X H: maksimum 237 mm x 227 mm x 43 mm; inklusiv batteriadapter

Leica GKL221 Ladeapparat

Brukerhåndbok

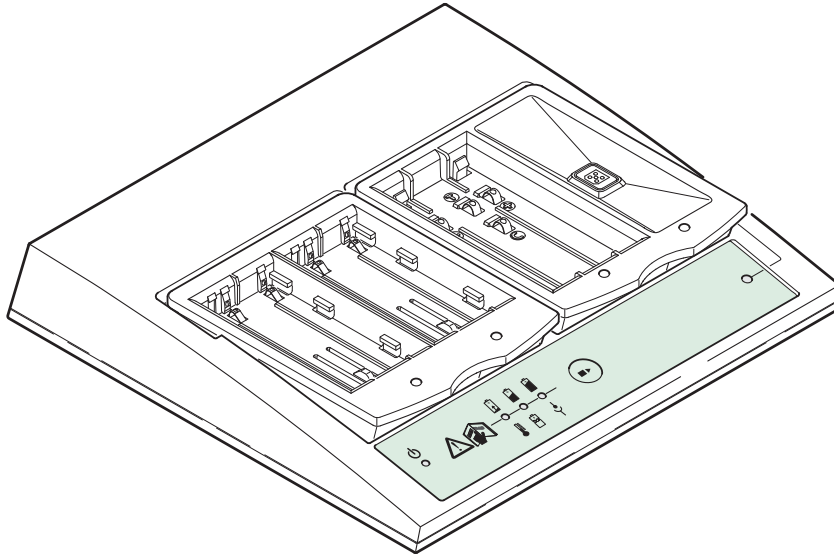

Versjon 1.3
Norsk

- when it has to be **right**

Leica
Geosystems

NO

Innledning



Denne brukerhåndboka inneholder bruksanvisning og viktige sikkerhetsinstrukser. Se kapittel "4 Sikkerhetsinstrukser" for ytterligere opplysninger. Brukerhåndboka må gjennomleses nøye før instrumentet tas i bruk.

Produktidentifisering





Typebetegnelsen og serienummeret for dette produktet er angitt på typeskiltet. Skriv opp type og serienummer i denne håndboka og oppgi alltid disse ved henvendelser til leverandøren eller et autorisert serviceverksted.

Type: _____

Serienr.: _____

Benyttede symboler

De symbolene som benyttes i denne brukerhåndboka, har følgende betydning:

Symbol	Betydning
 Fare	Angir umiddelbar fare ved bruk, som med sikkerhet har alvorlige personskader eller døden til følge.
 Advarsel	Farlig eller ufagmessig bruk som kan føre til alvorlige personskader eller død.
 Forsiktig	Farlig eller ufagmessig bruk som kan føre til mindre personskader, men til stor skade på materiell, verdier eller miljø.
	Viktige opplysninger som skal hjelpe brukeren til å benytte instrumentet på en teknisk korrekt og effektiv måte.

Innholdsfortegnelse

Innhold	Emne	Side
1	Systembeskrivelse	4
2	Betjening	8
	2.1 Batteriadapter	8
	2.2 Tilkopling av ladeapparatet	9
	2.3 Innsetting og fjerning av batterier	11
	2.4 Velger	14
	2.5 Lading av batteri	15
	2.6 Signallamper	17
	2.7 Tips	20
3	Vedlikehold og transport	21
	3.1 Transport	21
	3.2 Lagring	21
	3.3 Rengjøring og tørking	21
4	Sikkerhetsinstrukser	22
	4.1 Generelt	22
	4.2 Bruksområde	22
	4.3 Bruksbegrensninger	23
	4.4 Ansvarsområder	23
	4.5 Bruksfarer	23
	4.6 Elektromagnetisk kompatibilitet EMC	25
	4.7 FCC forskrift, gjeldende i USA	26
5	Tekniske data	28

NO

1

Systembeskrivelse

Beskrivelse

GKL221 fra Leica Geosystems er et intelligent ladeapparat med avansert teknologi for lading. Det egner seg til lading av alle batterier fra Leica Geosystems, både fra nettforsyningen og fra bilbatterier via biladapter GDC221. Ladeapparatet er et optimalt supplement til batteridrevet utstyr fra Leica Geosystems.

Generelle opplysninger

Det kan koples opp til fem batterier til ladeapparatet. Det er mulig å lade to batterier samtidig. Batteriene lades i den rekkefølge de ble tilkopleet. Ladeapparatet har i tillegg til batterilading også mulighet for utlading, vedlikeholdslading og gjenoppfrisking av batterier.



Det anbefales å ha denne brukerhåndbok for hånden når utstyret tas i bruk.

Systemkomponenter

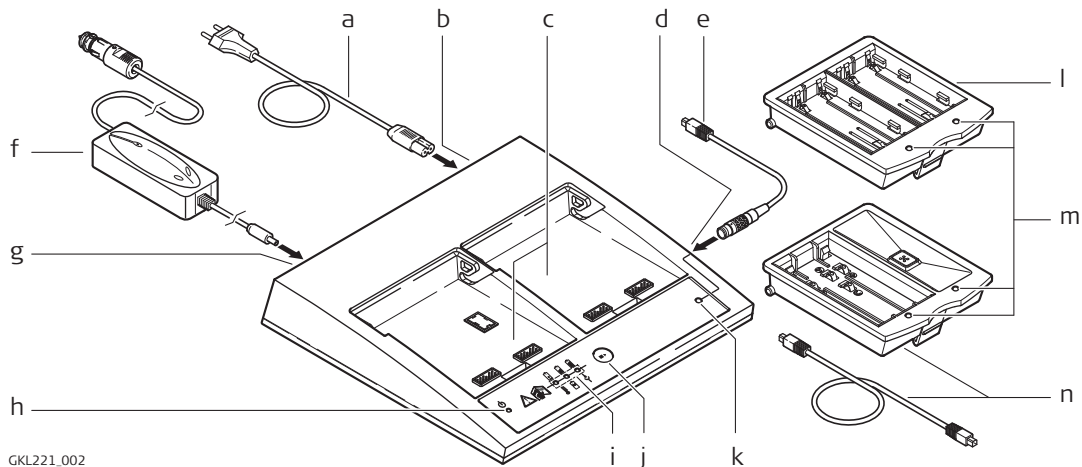

GKL221_002

- a) Nettkabel ifølge nasjonal standard
- b) Tilkopling for nettkabel
- c) Tilkoplinger I og II for batteriadapter GDI221 / GDI222
- d) Tilkopling for eksternt batteri
- e) Ladekabel for eksternt 5-polet batteri
- f) Biladapter GDC221, ekstra utstyr
- g) Tilkopling for biladapter
- h) Driftslampe
- i) Lamper for kapasitet og feil
- j) Velger
- k) Tilstandslampe for eksternt batteriadapter
- l) Batteriadapter GDI221, ekstra utstyr
- m) Tilstandslamper for batterier
- n) Batteriadapter GDI222 med tilsvarende 5-polet ladekabel, ekstra utstyr

Oppladbare batterier

Følgende batterier fra Leica Geosystems kan lades:

GEB90
GEB211
GEB212
GEB221
GEB222
GEB241
GEB242



GEB111
GEB121

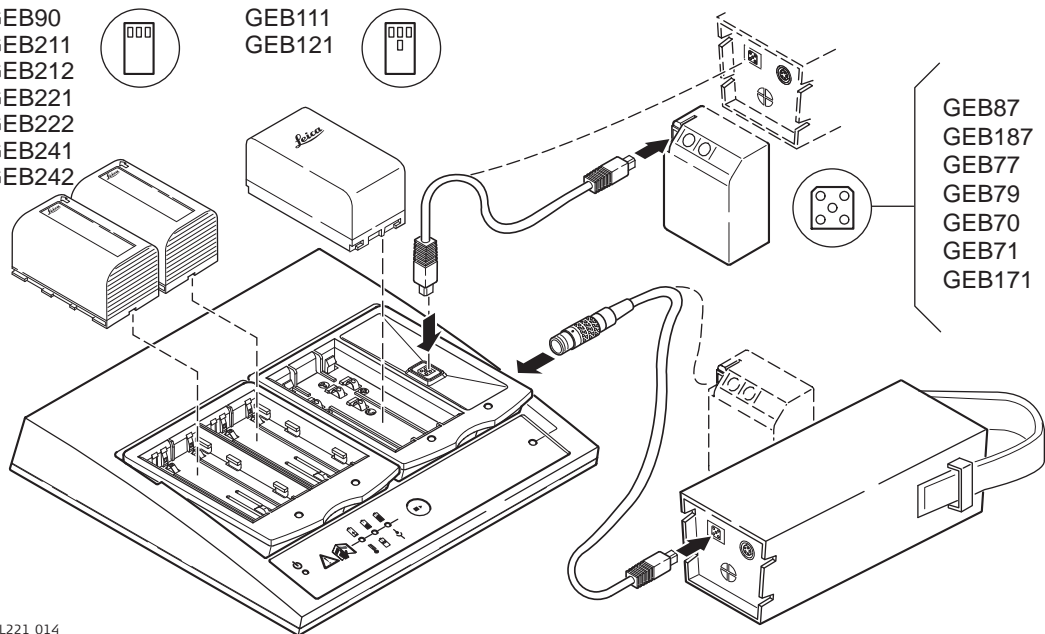

GKL221_014



Ladeapparatet er bare egnet for lading og utlading av originale batterier fra Leica Geosystems samt ulike standardbatterier av typen NiMH/NiCd for camcorder. Se kapittel "2.3 Innsetting og fjerning av batterier" for ytterligere opplysninger.

Ladeapparat og batteriadapter

Med ulike kombinasjoner av ladeapparat og batteriadaptere er det mulighet for lading av følgende batterier:

Ladeapparat / batteriadapter	Oppladbare batterier
GKL221 med to GDI221	Opp til fire batterier av typen Li-Ion og ett batteri med 5-polet ladekontakt.
GKL221 med ett GDI221 og ett GDI222	Opp til to batterier av typen Li-Ion, ett batteri i format for camcorder og to batterier med 5-polet ladekontakt.
GKL221 med to GDI222	Opp til to batterier i format for camcorder og tre batterier med 5-polet ladekontakt.

NO

2

2.1

Betjening

Batteriadapter

Formål

Batteriadapteren forbinder batteriene til ladeapparatet og har en signallampe for hver av tilkoblingene som viser batteriets ladetilstand.

Typen

Det finnes følgende typer av batteriadaptene:

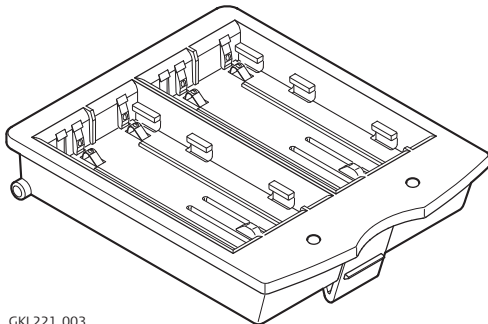

GKL221_003

GDI221

- For to batterier, GEB90, GEB211, GEB212, GEB221, GEB222, GEB241 eller GEB242 av typen Li-Ion fra Leica Geosystems.

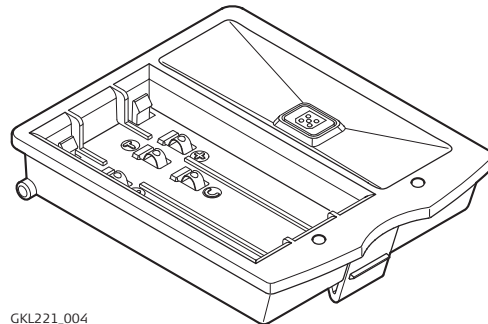

GKL221_004

GDI222

- For ett Leica Geosystems NiMH batteri GEB111 eller GEB121 pluss et NiCd eller NiMH 5-polet batteri.

Innsetting og fjerning

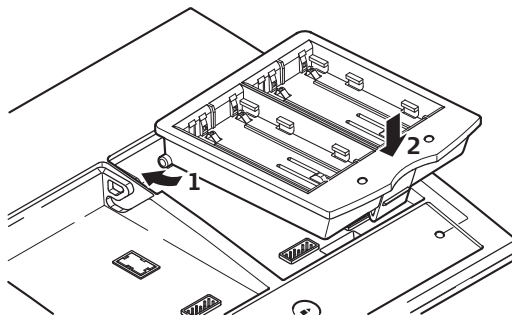

GKL221_005

Innsetting

1. Batteriadapteren skyves på plass ved hjelp av sporet bak.
2. Den smettes på plass med et trykk på området foran. Det høres tydelig og merkes når den smetter på plass.

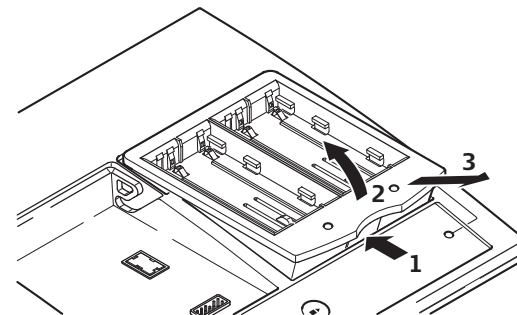

GKL221_006

Fjerning

1. Batteriadapteren utløses med et trykk på adapterets forkant.
2. Den dras lett oppover til anslaget.
3. Adapteren dras ut i fronten.

NO

2.2

Tilkopling av ladeapparatet

Advarsel

Ladeapparatet må bare brukes innendørs i tørre omgivelser! Våte eller fuktige apparater må ikke benyttes!

Betjening

Før bruken må det alltid sørges for et fast underlag for utstyret.

Ladeapparatet forbindes med enten:

- den medleverte nettkabelen til nettforsyningen eller
- biladapteren GDC211, som er valgfritt ekstrautstyr, og koples til bilens uttak for lighter.



For å sikre at strømforsyningen er slått av når ladeapparatet ikke skal brukes over lengre tid, må støpslet til nettet eller bilens uttak for lighter, dras ut.



Ladeapparatet må bare koples til bilbatteriet med biladapteren. Dersom lading skjer med andre former for strømforsyning, f.eks. nettaggregater med strømbegrensning, er det mulighet for feil funksjon. Se kapittel "5 Tekniske data" for ytterligere opplysninger om inngangsspenning og nominell effekt.



For eldre bilmodeller kan det være nødvendig å kontrollere at bilens uttak for lighter har riktig polaritet, dvs. positiv pol i senterkontakten. Ved feil polaritet må ladeapparatets sikring eller biladapterens sikring utskiftes. Ladeapparatets sikring må byttes av et serviceverksted som er autorisert av Leica Geosystems. Bytte av biladapterens sikring skjer ifølge brukerhåndboka for biladapteren.

Funksjonskontroll

Etter tilkøpling til nettet eller bilens uttak for lighter, vil batteriadapterens tilstandslamper lyse rødt, gult og grønt én gang, dessuten lyser lampene for kapasitet og feil, rødt og grønt. Dette utgjør en kontroll av funksjonen.

Dersom det ikke er tilkøplet noe batteri, vil bare driftslampen lyse grønt.

Dersom tilstandslampene og de tre lampene for kapasitet og feil lyser kontinuerlig rødt, har apparatet detektert en feil. Se kapittel "2.6 Signallamper" for ytterligere opplysninger.

2.3

Innsetting og fjerning av batterier

Batterier av typen Li-Ion

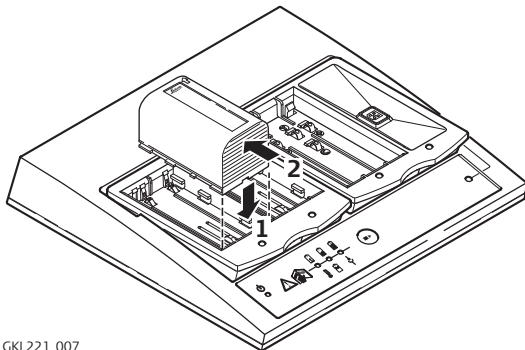

GKL221_007

Innsetting:

1. Batteriet legges plant inn mot fronten av batteriadapteren GDI221.
2. Batteriet skyves med et lett trykk nedover til anslag.

Fjerning

- Batteriet dras bakover til anslag og tas ut.

Advarsel

Det er bare tillatt å bruke ladeapparatet til å lade eller utlade batterier som anbefales av Leica Geosystems. Bruk bare batterier av typen Li-Ion fra Leica Geosystems.

NO

Batterier av typen NiCd og NiMH

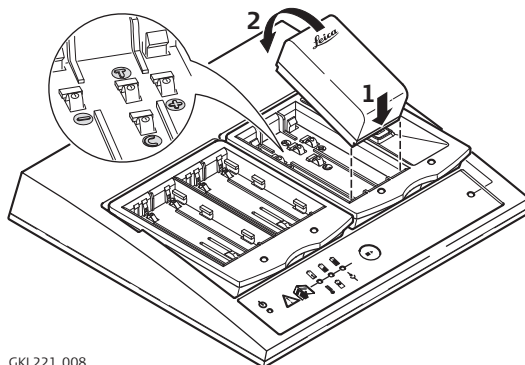

GKL221_008

Innsetting:

1. Legg batteriet mot fronten av batteriadapteren GDI222.
2. Trykk det nedover til det tydelig høres og merkes at det smetter på plass.

Fjerning

- Batteriet dras oppver mot baksiden og fjernes.



Batteriene GEB111 og GEB121 fra Leica Geosystems har fire kontaktflater mens camcorder-batterier fra andre leverandører bare har tre. Ladeapparatet kan skille mellom disse typene og tilpasse ladeforløpet.



Camcorder-batterier med tre kontaktflater må oppfylle følgende betingelser for å unngå skader:

- Spenning: 6 V
- Type: NiCd eller NiMH
- Minimum kapasitet: NiCd 1500 mAh, NiMH 1800 mAh
- kompatible kontakter, dvs. "+, T, -" i rekkefølge fra venstre mot høyre

Camcorder-batterier som oppfyller disse betingelsene, blir oppladet med temperaturovervåking og en ladestrøm på 1,6 A.

Batterier med 5-polet ladekontakt

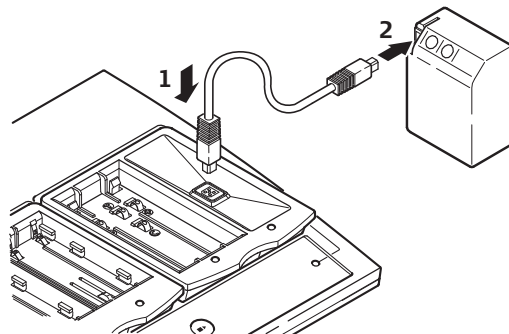

GKL221_009

Batterier fra Leica Geosystems med 5-polet ladekontakt, f.eks. GEB87 eller GEB70, tilkoples ladekontakten med 5 poler via ladekabelen.

Eksterne batterier med 5-polet ladekontakt

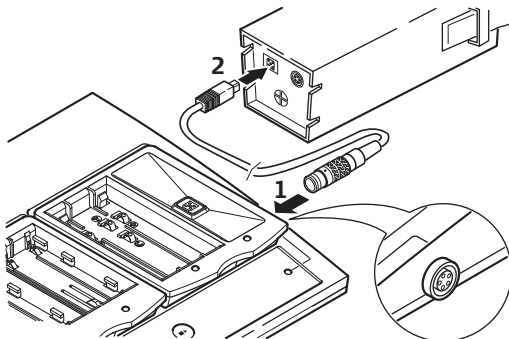

GKL221_010

Batterier fra Leica Geosystems med 5-polet ladekontakt, f.eks. GEB87 eller GEB70, forbindes med den eksterne batteriadapteren via ladekabelen.

👉 Batterier som er forbundet til ekstern batteriadapter, bør helst lades uten avbrudd av et ladeforløp som er på gang.

NO

2.4

Velger

Funksjon

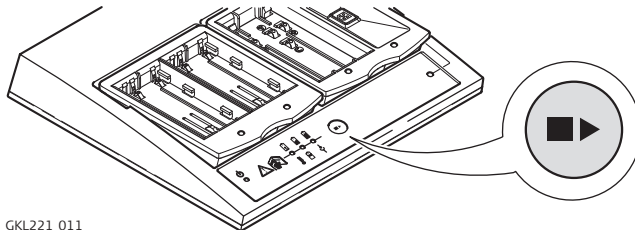

GKL221_011

Velgeren brukes til å velge en batteriadapter og til å veksle mellom lading og utlading.

Funksjon	Betjening av velger	Beskrivelse
Valg av batteriadapter	Trykkes i mindre enn to sekunder	Den neste batteriadapteren som har batteri, blir valgt. Den valgte batteriadapteren angis med raske gule blink i tilstandslampen i ca. tre sekunder, dessuten vises batteriets kapasitet.
Veksling mellom lading og utlading	Trykkes i mer enn tre sekunder	Ved omkopling til utlading vil tilstandslampen blinke gult og rødt, og ved omkopling til lading vil den blinke gult og grønt i ca. fem sekunder.



Utlading angis med rødt blink i tilstandslampen. Når utladingen er avsluttet, går tilstandslampen tilbake til grønt, dvs. opplading av batteriet.

2.5

Lading av batteri

Forløp

Fase	Beskrivelse
1.	Sett inn batteriadapteren.
2.	Ladeapparatet koples til strømforsyningen, driftslampen lyser grønt.
3.	Batteriet settes inn. Tilstandslampen blinker gult, dvs. batteriet er detektert.
4.	Det må kontrolleres at tilstandslampen lyser kontinuerlig grønt. Batteriet lades nå opp. Se kapittel "2.6 Signallamper" dersom det vises en annen tilstand etter at batteriet er tilkopleet.  Tilstandsvisningen bør kontrolleres på nytt etter ca. ett minutt.
5.	Batteriet er fullt oppladet når tilstandslampen blinker gult. Se kapittel "5 Tekniske data" for ytterligere opplysninger om ladetider.
6.	Batteriene kan enten tas ut eller bli sittende slik at de er oppladet og klare til bruk ved behov. Se kapittel "Lademuligheter" for ytterligere opplysninger.

Bestemmelse av rekkefølge for lading

Ladeapparatet GKL221 kan lade to batterier samtidig. Når det koples mer enn ett batteri til ladeapparatet, blir batteriene ladet i den rekkefølge de ble tilkopleet. Derfor må det batteriet som skal brukes først, også tilkoples først.

Prioritet



Batterier som er forbundet til ekstern batteriadapter, bør helst lades uten avbrudd av et ladeforløp som er på gang.

Vedlikeholdslading

Batterier kan fortsatt være tilkopleet, selv etter at de er ladet helt opp. Det gjennomføres en sekvensiell vedlikeholdslading av batterier av typen NiCd og NiMH. Dette kompenserer for den teknisk bestemte egenutlading av batteriene, og batteriene har full lading når de skal brukes. Se kapittel "Lademetoder" for ytterligere opplysninger.

Gjenoppfriskning av batteri

Gjenoppfriskning av batteriet består av en fullstendig utlading etterfulgt av en hurtigopplading.



Fase	Beskrivelse
1.	Ladeapparatet kobles til strømforsyningen.
2.	Batteriet settes inn. Tilstandslampen blinker gult, dvs. batteriet er detektert.
3.	Velgeren trykkes i mer enn tre sekunder for å starte utlading av det valgte batteriet. Utlading angis med rødt blink i tilstandslampen.  Det kan ta lang tid å lade ut store batterier. For å redusere utladetiden bør denne funksjonen derfor bare benyttes for flate eller nesten flate batterier!
4.	Når batteriet er ferdig utladet, blir det automatisk hurtigladet. Tilstandslampen lyser da grønt.
5.	Batteriet er fullt oppladet når tilstandslampen blinker gult.
	Det anbefales å gjennomføre gjenoppfriskning av batterier av typene NiCd og NiMH to eller tre ganger når kapasiteten er merkbart redusert.
	For batterier av typen Li-Ion er det tilstrekkelig med utlading og lading en enkelt gang. Det anbefales å gjennomføre dette når den kapasiteten som angis på ladeapparatet eller et annet produkt fra Leica Geosystems, avviker vesentlig fra den kapasiteten som faktisk er til rådighet.

NO



2.6

Signallamper





Symbolenes betydning

Symbol	Betydning
	Lampe slukket.
	Lampe lyser kontinuerlig.
	Lampe blinker.



Driftslampe

Symbol	Lampe	Betydning
	Slukket	Ladeapparatet er ikke koplet til noen strømforsyning.
	Grønn	Ladeapparatet er koplet til en strømforsyning.

Tilstandslamper

Symbol	Lampe	Betydning
	Slukket	Det er ikke detektert noe tilkoplede batteri.
	Gul	Ladeapparatet har detektert et tilkoplede batteri. Det venter mens to andre batterier blir ladet eller utladet.
	Grønn	Tilkoplede batteri lades opp.
	Grønn	Tilkoplede batteri er helt oppladet og kan tas ut.
	Rød	Ladeapparatet har detektert en feil.

NO





Symbol	Lampe	Betydning
	Rød	Batteri er tilkople for gjenoppfrisking. Det er i utladingsfasen.
	Gul	Indikasjon av aktiv, dvs. valgt batteriadapter.

Indikasjon av kapasitet og feil

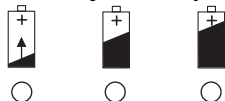
- Ved normal drift vil de tre lampene for kapasitet og feil vise batteriets kapasitet for det valgte batteriadapteret og lyse grønt. Lampen lyser i ca. ti til femten sekunder etter valg av en batteriadapter, deretter slukkes den.
- Dersom det oppstår en feil, vil feilkoden for den valgte batteriadapteren angis med rødt av lampene for kapasitet og feil.

Indikasjon av kapasitet



Lamper	Betydning
	Batteriets ladetilstand er mindre enn 20 %.
	Batteriets ladetilstand er minst 20 %.
	Batteriets ladetilstand er minst 50 %.
	Batteriets ladetilstand er minst 80 %.



Indikasjon av kapasitet er inntil videre bare mulig for batteritypene GEB211, GEB212, GEB221, GEB222, GEB241, GEB242 og GEB90 fra Leica Geosystems.

Indikasjon av feil

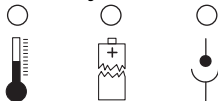

Lamper	Betydning	Tiltak
	For høy eller lav batteritemperatur.	Se kapittel "Temperaturområde" for ytterligere opplysninger.
	Defekt batteri.	Bytt batteri.
	Dårlig kontakt til batteri eller batteriaadapter.	Kontroller kontakten.
	Feil i ladeapparatets utstyr.	Ta kontakt med et serviceverksted som er autorisert av Leica Geosystems.



Når ladeapparatet indikerer feil med tilkoplett batteri:

- Prøv å tilkople et annet batteri for å se om feilen skyldes batteriet eller ladeapparatet.
- Dersom problemet fortsetter må det søkes hjelp fra et serviceverksted som er autorisert av Leica Geosystems.



Når det oppstår feil bør dessuten følgende undersøkes:

- Er det strømforsyning fra nettet eller bilens uttak for lighter?
- Er kablet korrekt tilkoplett og uten synlige defekter?
- Ved tilkopleing av valgfritt ekstrautstyr for strømforsyning fra bilens uttak for lighter: Lyser driftslampen for adapteren til bilens uttak?

NO

2.7

Tips

Tips

- For å oppnå maksimal utnyttelse av batteriene bør nye batterier av typen NiCd og NiMH lades helt opp og helt ut tre til fem ganger.
 - Batteriene bør utlades mest mulig i instrumentet. Dermed elimineres den såkalte minne-effekten i batterier av typen NiCd.
 - Ved bruk av adapter for bilens uttak for lighter må det sørges for at motoren er i gang under lading.
-



Unngå raske temperaturstigninger i omgivelsene under lading, f.eks. solstråling på ladeapparatet og batteriene. Raske temperaturstigninger i omgivelsene kan føre til at ladingen avsluttes for tidlig og at batterikapasiteten derved reduseres.

3

Vedlikehold og transport

3.1

Transport

Forsendelse

Ved forsendelse med jernbane, fly eller skip må det alltid benyttes komplett emballasje fra Leica Geosystems, Transportbeholder og forsendelseskartong eller eventuelt tilsvarende innpakking. Emballasjen beskytter produktet mot slag og vibrasjoner.

3.2

Lagring

Produkt

Vær oppmerksom på lagringstemperaturen ved oppbevaring av utstyret, spesielt om sommeren når utstyret oppbevares inne i kjøretøy. Se kapittel "5 Tekniske data" med opplysninger om temperaturområdet for lagring.

3.3

Rengjøring og tørking

Produkt

Bruk bare en ren og myk klut til rengjøring.

Kabler og plugg

Plugg må ikke utsettes for støv eller skitt, og de må beskyttes mot fukt. Støv i kabelpluggene må blåses ut.

NO

4

Sikkerhetsinstrukser

4.1

Generelt

Beskrivelse

Disse instruksene skal sette den som har ansvar for - og den som betjener utstyret, i stand til å oppdage eventuelle farer som er forbundet med bruken i rett tid, eller så vidt mulig unngå at slike farer oppstår.

Den som har ansvar for utstyret er forpliktet til å sørge for at alle brukere forstår og følger disse instruksene.

4.2

Bruksområde

Tillatt bruk

- Lading og utlading av batterier med ulike typer av celler.

Ulovlig bruk

- Bruk av utstyret uten instruksjon
- Bruk utenfor gitte grenseverdier
- Sette sikkerhetsanordninger ut av funksjon
- Fjerne anvisninger og advarselskilt
- Åpne utstyret med verktøy, f.eks. skrutrekker osv, dersom dette ikke er uttrykkelig tillatt i visse tilfelle
- Modifisering eller ombygging av utstyret
- Bruk etter vraking
- Bruk av utstyr med tydelige mangler eller skader
- Bruk av tilbehør fra andre fabrikanter dersom dette ikke er uttrykkelig godkjent av Leica Geosystems.



Advarsel

Mulighet for personskade, feilfunksjon og materiell skade ved ukorrekt bruk.

Den som har ansvar for instrumentet må informere brukeren om farer som er forbundet med bruken av utstyret samt beskyttende tiltak. Utstyret må ikke tas i bruk før brukeren er instruert.

4.3 Bruksbegrensninger

Miljø

Tillatt for innendørs bruk i tørre rom uten farlige miljøpåvirkninger.

4.4 Ansvarsområder

Utstyrproduzenten

Leica Geosystems AG, CH-9435 Heerbrugg, forkortet Leica Geosystems, står ansvarlig for en sikkerhetsteknisk feilfri leveranse av utstyret, inklusive brukerhåndbok og originaltilbehør.

Produsenter av fremmed tilbehør

Fabrikanter av fremmed tilbehør for utstyret er ansvarlige for utvikling, omsetning og informasjon om sikkerhetskonsepter for sine produkter samt for funksjonen av disse i kombinasjon med utstyret fra Leica Geosystems.

Den som betjener utstyret

For den som betjener utstyret gjelder følgende plikter:

- Vedkommende skal forstå verneinformasjonen på utstyret og instruksjonene i brukerhåndboka.
- Vedkommende skal kjenne de stedlige forskrifter for arbeidsmiljø og sikkerhet.
- Vedkommende skal underrette Leica Geosystems straks det oppdages mangler ved utstyret som har betydning for en sikker bruk av dette.

Advarsel

Den som er ansvarlig for utstyret står ansvarlig for forskriftmessig bruk av utstyret, brukernes arbeidsinnsats, instruksjon av brukere og at utstyret er i driftsikker tilstand.

4.5 Bruksfarer

Advarsel

Manglende eller utilstrekkelig instruksjon kan føre til feil betjening eller ukorrekt bruk. Dette kan resultere i ulykker med alvorlige personskader samt skader på materiell, verdier og miljø.

Forholdsregler:

Alle brukere må følge sikkerhetsforskriftene fra produsenten og direktiver gitt av ansvarshavende.

Advarsel

Utstyret er ikke beregnet til bruk i fuktig og farlig miljø. Dersom fukt trenger inn i utstyret kan det føre til personskade på grunn av elektrisk støt.

Forholdsregler:

Bruk bare utstyret innendørs i tørre omgivelser, f.eks. i et bygg eller en bil.

Beskytt utstyret mot fukt. Utstyr som er blitt vått, må ikke benyttes!

Advarsel

Når utstyret åpnes er det fare for elektrisk støt ved følgende forhold:

- Berøring av strømførende deler.
- Bruk etter ukorrekt reparasjonsforsøk.

Forholdsregler:

Utstyret må ikke åpnes. Reparasjoner må bare overlates til et serviceverksted som er autorisert av Leica Geosystems.

Advarsel

Ved lading og utlading av batterier som ikke er anbefalt av Leica Geosystems, kan batteriene skades. Dette kan føre til brann- og eksplosjonsfare.

Forholdsregler:

Det er bare tillatt å lade eller utlade batterier som er anbefalt av Leica Geosystems.

Advarsel

Dersom produktet kasseres uforvarlig, kan følgende skje:

- Når plastdeler brennes kan det dannes giftige gasser som kan være helsefarlige.
- Når batterier skades eller overopphetes kan de eksplodere og være årsak til forgiftning, brann, korrosjon eller miljøforsøpling.
- Ved uansvarlig avfallshåndtering av utstyret er det mulighet for at uvedkommende kan bruke det i strid med forskrifter og dermed utsette seg selv eller andre for alvorlige personskader og miljøet kan risikere å bli forurenset.

Forholdsregler:

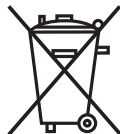

Produktet må ikke kastes i husholdningsavfallet.
Utstyret må kasseres på forsvarlig måte i samsvar med gjeldende nasjonale forskrifter.
Sørg alltid for at ingen uvedkommende har adgang til utstyret.

Produktspesifikk håndtering og avfallshåndtering kan lastes ned fra hjemmesiden til Leica Geosystems på <http://www.leica-geosystems.com/treatment> eller du kan få dette tilsendt fra din Leica Geosystems-forhandler.

4.6

Elektromagnetisk kompatibilitet EMC

Beskrivelse

Med elektromagnetisk kompatibilitet menes utstyrets evne til å virke korrekt i et felt med elektromagnetisk stråling og elektrostatisk utlading uten å forårsake elektromagnetiske forstyrrelser av andre apparater.

Advarsel

Mulighet for forstyrrelse av andre apparater på grunn av elektromagnetisk stråling.
Selv om utstyret oppfyller de strenge kravene ifølge gjeldende standarder, kan ikke Leica Geosystems helt utelukke muligheten for forstyrrelse av andre apparater.

Forsiktig

Det er mulighet for å forstyrre andre apparater når utstyret brukes i kombinasjon med fremmed utstyr som f.eks. diverse kabler eller eksterne batterier.

Forholdsregler:

Bruk bare utstyr eller tilbehør som er anbefalt av Leica Geosystems. I kombinasjon med utstyret oppfylles de strenge kravene ifølge gjeldende retningslinjer og normer.

Advarsel

Når utstyret brukes med en kabel som er åpen i den ene enden, f.eks. en ekstern matekabel, kan de tillatte grenseverdiene for elektromagnetisk stråling overskrides, og andre apparater kan dermed bli forstyrret.

Forholdsregler:

Når utstyret er i bruk, må kabler tilkoples i begge ender, f.eks. til instrument og eksternt batteri.

4.7

FCC forskrift, gjeldende i USA

Advarsel

Dette apparatet har under forsøk overholdt de grenseverdiene som foreskrives i FCC forskriftenes avsnitt 15 for digitale apparater i klasse B.

Disse grenseverdiene gir tilstrekkelig beskyttelse for installasjoner i boligområder mot forstyrrende stråling.

Apparater av den aktuelle typen produserer og anvender høyfrekvens, og de kan også avgi slik høyfrekvent utstråling. Dermed kan de også være årsak til forstyrrelse av radio- og TV-mottakere, når de ikke installeres og benyttes i samsvar med anvisningene.

Det kan imidlertid ikke garanteres at ikke forstyrrelser likevel kan forekomme ved bestemte installasjoner.

Dersom dette apparatet er årsak til forstyrrelser av radio- eller TV-mottakere, hvilket kan påvises ved å slå apparatet av og på igjen, er brukeren forpliktet til å avhjelpe problemet ved hjelp av følgende tiltak:

- Omplussing eller bytte av mottakerantennen.
 - Øke avstanden mellom apparatet og mottakeren.
 - Tilkopling av apparatet til et nettstøpsel fra en annen kurs enn den som mottakeren er koplet til.
 - Konsultasjon med en forhandler eller en erfaren servicetekniker for radio og TV.
-

Advarsel

Endringer og modifikasjoner som ikke er uttrykkelig tillatt av Leica Geosystems, kan medføre begrensninger i brukers rett til å benytte apparatet.

5

Tekniske data

Strømforsyning

- Nettilslutning, ~
- Likespenningstilslutning, ==

Inngangsspenning

- 100 - 240 VAC, 50/60 Hz
- 24 VDC

Ladeeffekt

maksimalt 18 VDC / maksimalt 4,0 A; avhengig av batteritype

Utladeeffekt

4 W

Nominell effekt

~ : 75 W ==55 W

Bruksmiljø

Må bare brukes innendørs i tørre rom, f.eks. i bygg eller bil
IP40, ifølge IEC60529

Temperaturområde

Lagring:	-40 °C til +70 °C	-40 °F til +158 °F
Drift:	~ : 0 °C til +40 °C	+32 °F til 104 °F
	== : 0 °C til +50 °C	+32 °F til 122 °F

Lademetoder

Hurtiglading skjer for:

- Alle batterier fra Leica Geosystems. Disse er utrustet med temperaturovervåking og batteridetektering. Ladestrøm maksimalt 4,0 A, avhengig av batteriet.
- Alle standard camcorderbatterier med tre kontaktflater og temperaturovervåking. Ladestrøm maksimalt 1,6 A

Langsom lading skjer for:

- Batterier av typen NiCd og NiMH med temperatur under +10 °C.
- Batterier av typen Li-Ion med temperatur under +6 °C
- Nesten eller helt flate batterier av typen Li-Ion, NiCd og NiMH.

Vedlikeholdslading skjer for:

- Batterier av typen NiCd og NiMH Ladestrømmen avhenger av batteriet. Ladingen skjer i intervaller på ca. femten sekunder per batteri.



For batterier av typen Li-Ion er det ikke nødvendig med vedlikeholdslading, fordi det er liten selvutlading.

Ladeteknologi

Kriterier for utkopling ved hurtiglading:

For batterier av typen NiCd og NiMH:

Tidsstyring
Kapasitet
Batteritemperatur
Negativ spenningsdifferanse
Temperaturstigning per minutt
Repetisjonsgradientmetode (vendepunktmetode)

For batterier av typen Li-Ion:

Tidsstyring
Kapasitet
Batteritemperatur
Ladestrøm

Vedlikeholdslading av batterier av typen NiCd og NiMH:

Overvåking av batterispenning, ladestrøm og batteritemperatur.

Celletyper

- NiCd
- NiMH
- Li-Ion

Lade- og utladetider

Tider for lading og utlading er først og fremst avhengig av maksimal lade- og utladestrøm, batterikapasitet og ladetilstanden ved innsetting.

Følgende verdier er retningsgivende:

Hurtiglading ved 20 °C:

Batterier av typen NiCd

opp til 2200 mAh 1,0 til 1,5 h

opp til 7200 mAh 2,5 til 4,0 h

Batterier av typen NiMH

opp til 2200 mAh 1,5 til 2,0 h

opp til 4900 mAh 2,0 til 2,5 h

opp til 10000 mAh 2,5 til 5,5 h

Batterier av typen Li-Ion

opp til 4600 mAh 2,5 til 3,5 h

Utlading:

Batterier av typen NiCd og NiMH:

6 Volts batterier med 600 mAh per time

12 Volts batterier med 300 mAh per time

Batterier av typen Li-Ion

7,4 Volts batterier med 500 mAh per time

NO

Signallamper

Se kapittel "2.6 Signallamper".

Vekt

Ladeapparat med to batteriadaptere: 1,12 kg

Utvendige dimensjoner

B X D X H: maksimalt 237 mm x 227 mm x 43 mm; inklusive batteriadapter

Leica GKL221 Acculader

Gebruiksaanwijzing

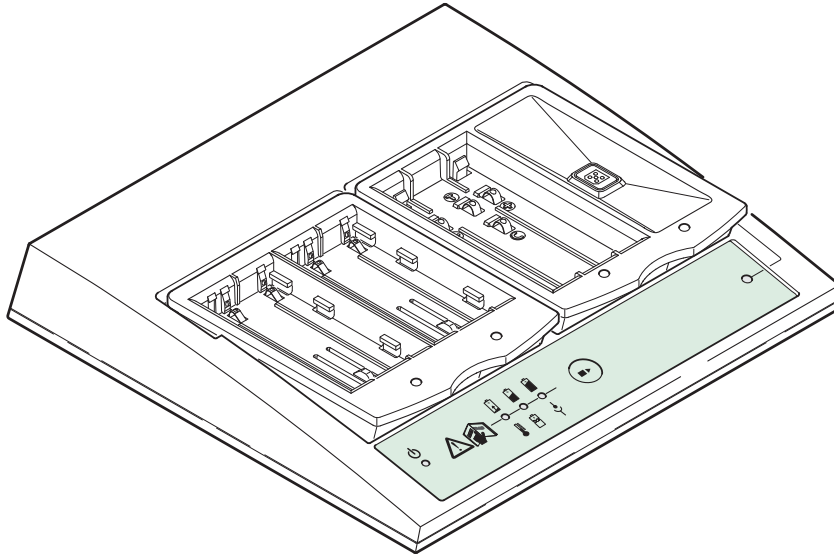

Versie 1.3
Nederlands

- when it has to be **right**

Leica
Geosystems

Introductie



Deze gebruiksaanwijzing bevat naast de aanwijzingen voor gebruik ook belangrijke veiligheidstips. Zie hoofdstuk "4 Veiligheidsvoorschriften" voor aanvullende informatie. Lees voor u het apparaat in gebruik neemt de gebruiksaanwijzing zorgvuldig door.

Productidentificatie





Het type en serienummer staan vermeld op de sticker op de onderzijde van het laadapparaat. Vul deze gegevens in op deze bladzijde en refereer bij vragen aan een van de geautoriseerde Leica Geosystems service centra altijd aan deze gegevens.

Type: _____

Serienr.: _____

Gebruikte Symbolen

De symbolen, die in dit handboek zijn gebruikt, hebben de volgende betekenis:

Symbool	Betekenis
 Gevaar	Direct gevaar bij gebruik, dat beslist leidt tot ernstig lichamelijk letsel of de dood.
 Waarschuwing	Gevaar bij gebruik of onjuist gebruik, dat kan leiden tot ernstig lichamelijk letsel of de dood.
 Voorzichtig	Gevaar bij gebruik of onjuist gebruik, dat tot gering lichamelijk letsel en/of aanzienlijke materiële, financiële of milieuschade kan leiden.
	Gebruiksinformatie, welke de gebruiker helpt, om het instrument technisch juist en efficiënt toe te passen.

Inhoudsopgave

Inhoud	Onderwerp	Pagina
1	Systeembeschrijving	4
2	Werking	8
	2.1 Accu Adapter	8
	2.2 Aansluiten van de Lader	9
	2.3 Inzetten en Uitnemen van Accu's	11
	2.4 Selectietoets	14
	2.5 De Accu Opladen	15
	2.6 Indicatie Lampjes	17
	2.7 Tips	20
3	Verzorging en Vervoer	21
	3.1 Vervoer	21
	3.2 Opslag	21
	3.3 Onderhoud en Drogen	21
4	Veiligheidsvoorschriften	22
	4.1 Algemene Informatie	22
	4.2 Gebruiksdoel	22
	4.3 Beperkingen in het Gebruik	23
	4.4 Verantwoordelijkheden	23
	4.5 Gebruiksrisico's	24
	4.6 Elektromagnetische Verdraagbaarheid	25
	4.7 FCC Verwijzing, geldig in de VS	26
5	Technische Specificaties	28

1

Systeembeschrijving

Beschrijving

De Leica Geosystems GKL221 is een intelligente acculader met geavanceerde oplaad-technologie. Hij is ontworpen om alle Leica accu's te kunnen opladen. De GKL221 kan op een stopcontact worden aangesloten, maar ook via de GDC221 voertuigadapter op de aansluiting voor een sigarettenaansteker in een voertuig. De GKL221 is een zeer bruikbare aanvulling op al uw batterij of accu gevoede Leica Geosystems producten.

Algemene Informatie

Tot vijf accu's kunnen tegelijkertijd op de lader worden aangesloten. Er kunnen twee accu's tegelijkertijd worden opgeladen. Als meer dan twee accu's zijn aangesloten, dan zullen de overige accu's worden opgeladen in de volgorde waarin ze werden aangesloten. Behalve opladen, kan de lader ook accu's ontladen en verversen.



Wij adviseren om op dit moment het product in te schakelen en daarna door te gaan met het lezen van deze handleiding.

System Componenten

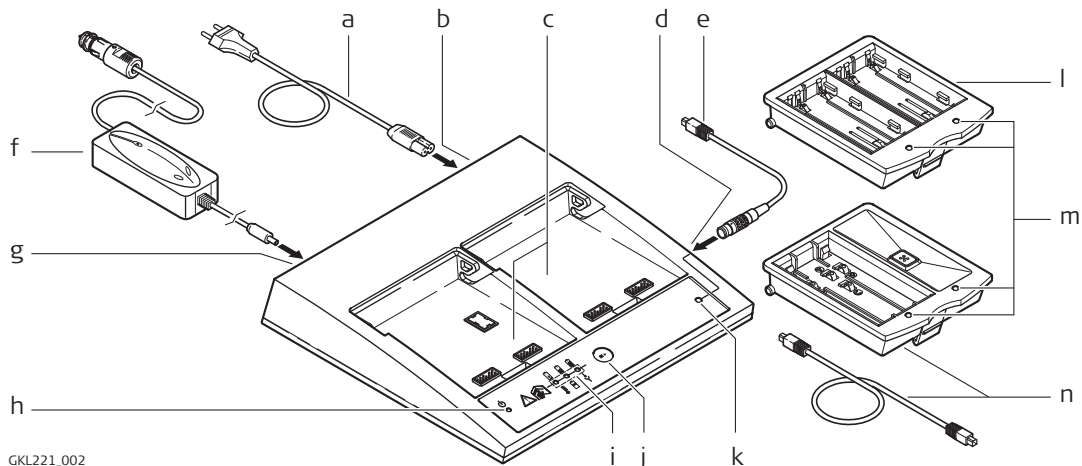

GKL221_002

- a) Netstroomkabel, specifiek per land
- b) Aansluiting op de lader voor de netstroomkabel
- c) Adapter slots I en II voor de GDI221 / GDI222 accu-adapters
- d) Kabelaansluiting voor externe accu's
- e) Kabelaansluiting 5-polig voor externe accu's
- f) Voertuigadapter GDC221, optioneel
- g) Kabelaansluiting voor voertuigadapter
- h) Functie indicatie
- i) Capaciteit en foutindicaties
- j) Selectietoets
- k) Statusindicatie voor aangesloten externe accu
- l) GDI221 accu-adapter, optioneel
- m) Accu statusindicaties
- n) GDI222 accu-adapter en 5 polige aansluitkabel, optioneel

NL

Oplaadbare Batterijen

De volgende Leica Geosystems accu's kunnen worden geladen:

GEB90
GEB211
GEB212
GEB221
GEB222
GEB241
GEB242



GEB111
GEB121

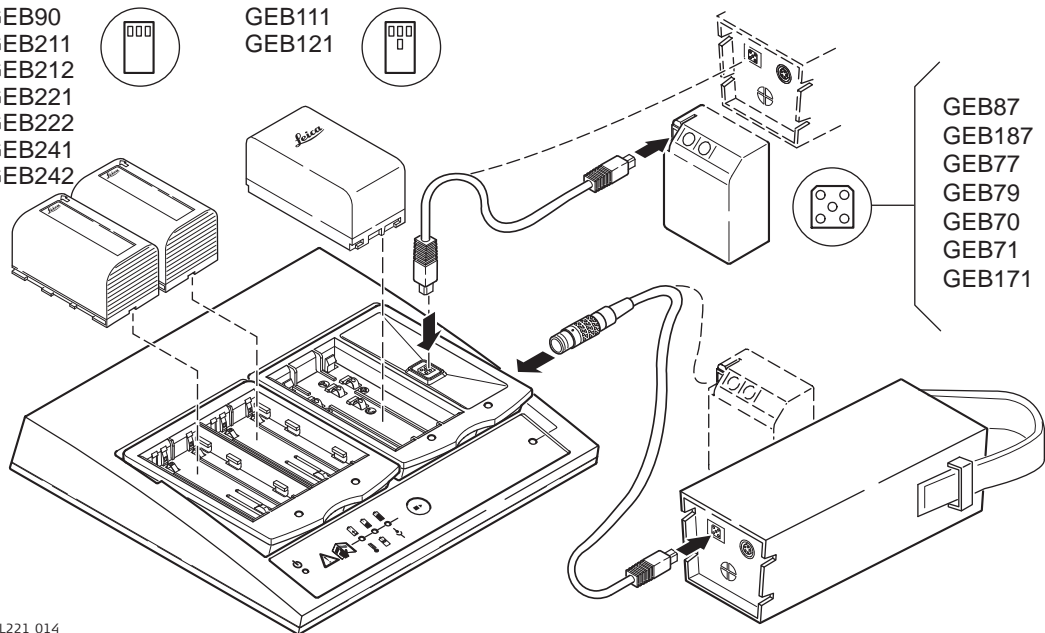

GEB87
GEB187
GEB77
GEB79
GEB70
GEB71
GEB171

GKL221_014



De lader is ontworpen om originele Leica accu's, zowel als enkele NiMH/NiCd camcorder accu's te kunnen opladen en ontladen. Zie hoofdstuk "2.3 Inzetten en Uitnemen van Accu's" voor verdere informatie.

Lader en Accu-adapters

Gebruik van de lader in combinatie met de accu-adapters biedt de mogelijkheden om de volgende accu's op de lader aan te sluiten:

Lader / Accu-adapter	Oplaadbare Batterijen
GKL221 met twee GDI221	Tot vier Li-Ion accu's en een accu met een 5 polige aansluiting.
GKL221 met een GDI221 en een GDI222	Tot twee Li-Ion accu's , een camcorder type accu en twee accu's met een 5 polige aansluiting.
GKL221 met twee GDI222	Tot twee camcorder type accu's en drie accu's met een 5 polige aansluiting.

2

2.1

Werking

Accu Adapter

Gebruiksdoel

De accu-adapter verbindt de lader met de corresponderende accu's en heeft een LED voor elk slot om de status van de accu aan te geven.

Type

De volgende accu-adapters zijn beschikbaar:

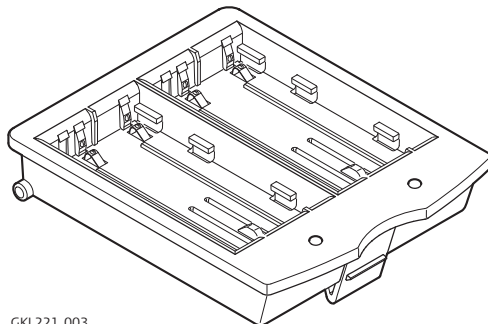

GKL221_003

GDI221

- Voor het aansluiten van twee Leica Geosystems Li-Ion accu's GEB90, GEB211, GEB212, GEB221, GEB222, GEB241 of GEB242.

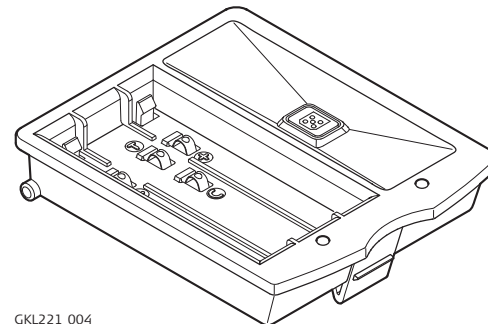

GKL221_004

GDI222

- Voor een Leica Geosystems NiMH accu GEB111 of GEB121 en een NiCd of NiMH 5 polige accu.

Inzetten en Uitnemen

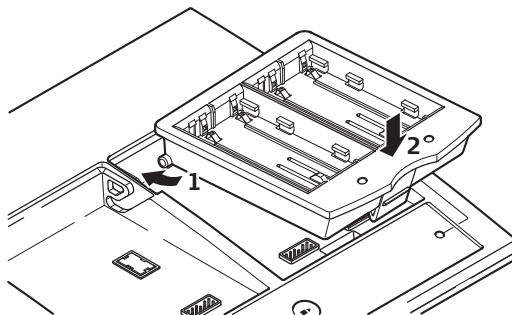

GKL221_005

Inzetten

1. Plaats de accu-adapter tegen de rand aan de achterzijde.
2. Druk op de voorkant van de adapter tot deze op zijn plaats vastklikt.

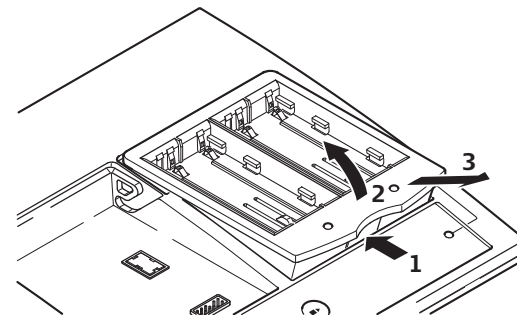

GKL221_006

Uitnemen

1. Druk op de voorzijde van de adapter om deze te openen.
2. Til hem voorzichtig omhoog tot de stop.
3. Neem de adapter uit door deze naar voren eruit te trekken.

2.2

Aansluiten van de Lader

Waarschuwing

Gebruik de lader alleen in droge ruimtes! Gebruik de lader nooit als deze nat of vochtig is!

Opstarten

Plaats de lader altijd op een stevige ondergrond alvorens deze in te schakelen.

Sluit de lader aan ofwel:

- Met de geleverde netspanningskabel op een stopcontact of
- Met de optionele GDC211 voertuigadapter op de accu van het voertuig.



Neem de stekker uit het stopcontact of de sigarettenaansteker bij gebruik van de voertuigadapter als de lader gedurende langere tijd niet zal worden gebruikt.



Gebruik de voertuigadapter alleen in een voertuig. Als de voeding van een andere bron komt, zoals een transformator, dan kan de lader defect raken. Zie hoofdstuk "5 Technische Specificaties" voor informatie over spanning en opgenomen vermogen.



Let bij oudere type auto's op de juiste aansluiting van de sigarettenaansteker (+ pool op het middencontact). Bij een verkeerde polariteit moet de zekering in de voertuigadapter of in de lader worden verwisseld. De zekering in de lader moet worden verwisseld door een geautoriseerde Leica Geosystems service werkplaats. De zekering in de voertuigadapter moet worden verwisseld volgens de instructies in de gebruiksaanwijzing van de adapter.

Functionele Controle

Nadat de adapter is aangesloten op netstroom of voertuigaccu, zullen de rode, gele en groene functie-indicaties (LED's) oplichten. De capaciteits- en foutindicaties zullen rood en groen oplichten. Dit is de zelftest.

Als er geen accu was aangesloten, dan zal alleen de groene functie-indicatie oplichten.

Als de statusindicatie en de drie capaciteits- en foutindicatoren oplichten en rood blijven branden, dan is er een defect gedetecteerd. Zie hoofdstuk "2.6 Indicatie Lampjes" voor aanvullende informatie.

2.3

Inzetten en Uitnemen van Accu's

Li-Ion Accu's

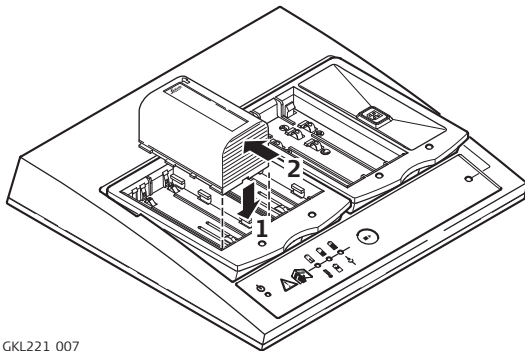

GKL221_007

Inzetten:

1. De accu gelijk met de voorzijde van de GDI221 adapter slot inzetten.
2. Duw de accu met lichte druk naar beneden tot de stop.

Uitnemen:

- Duw de accu naar achteren tot de stop en neem deze vervolgens uit.

Waarschuwing

Alleen accu's laden en ontladen, die worden aanbevolen door Leica Geosystems. Gebruik alleen Li-Ion accu's van Leica Geosystems.

NL

NiCd en NiMH Accu's

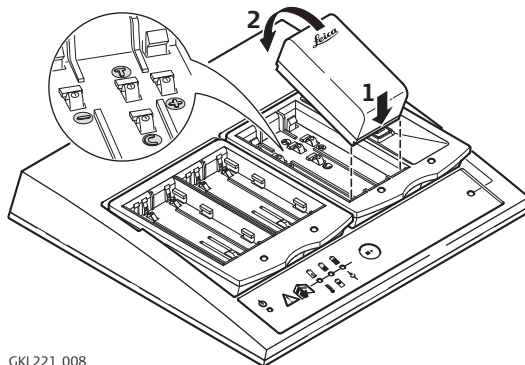

GKL221_008

Inzetten:

1. De accu tegen de voorkant van de GDI222 adapter slot inzetten.
2. Duw de accu naar beneden totdat hij vastklikt.

Uitnemen:

- Trek de accu aan de achterzijde omhoog en neem hem uit.



De Leica Geosystems GEB111 en GEB121 accu's hebben vier contactvlakken, terwijl camcorder accu's van andere fabrikanten slechts drie contacten hebben. De lader kan het verschil tussen de twee types herkennen en het laadproces hierop afstemmen.



Camcorder accu's met drie contacten moeten aan de volgende specificaties voldoen teneinde schade te voorkomen:

- Spanning: 6 V
- Type accu: NiCd of NiMH
- Minimum capaciteit: NiCd 1500 mAh, NiMH 1800 mAh
- Overeenkomstige contacten in de juiste aansluitvolgorde: "+, T, -" op rij.

Camcorder accu's, die aan deze specificaties voldoen zullen worden bewaakt op temperatuur en geladen met een stroom van 1.6 A.

Accu's met 5 Polige Aansluiting

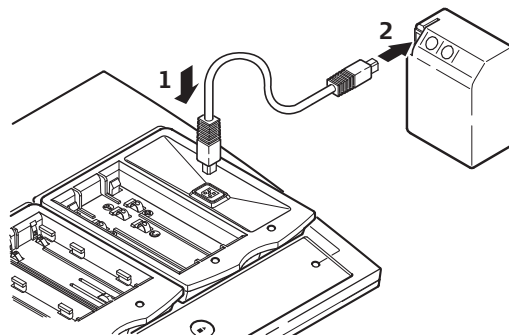

GKL221_009

Leica Geosystems accu's met 5 polige aansluiting, zoals de GEB87 of GEB70, moeten worden aangesloten via de 5 polige laadstekker van de verbindingkabel.

Externe Accu's met 5 Polige Aansluiting

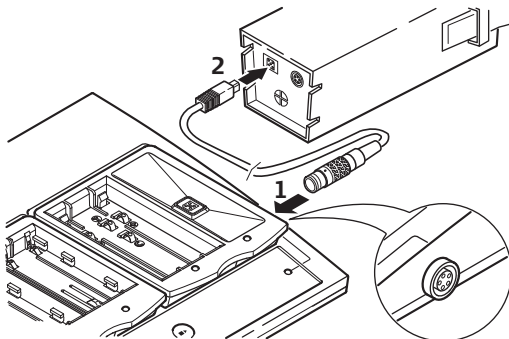

GKL221_010

Leica Geosystems accu's met 5 polige aansluiting, zoals de GEB87 of GEB70, moeten worden aangesloten op de stekker voor externe accu's van de verbindingkabel.

☞ Accu's verbonden met de aansluiting voor externe accu's kunnen worden opgeladen, zonder een reeds begonnen laadproces af te breken.

NL

2.4

Selectietoets

Functies

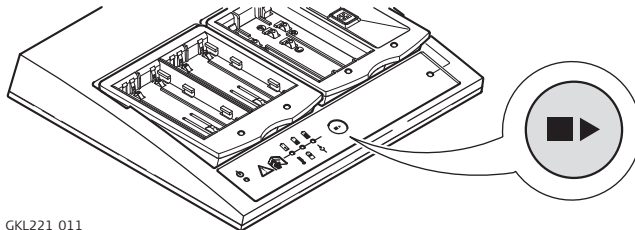

GKL221_011

De selectietoets wordt gebruikt om een oplaad slot te selecteren en om te wisselen tussen oplaad- en ontladmodus.

Funcities	Druk op de Selectietoets	Omschrijving
Selecteer het Oplaad Slot	Korter dan twee seconden	Het volgende slot wordt geselecteerd. Het geselecteerde slot wordt aangegeven door de gele statusindicatie, die gedurende drie seconden snel zal knipperen; tevens wordt de capaciteit van de accu weergegeven .
Wisselen tussen Oplaad- en Ontladmodus	Langer dan drie seconden	Wisselen naar de modus ontladen heeft tot gevolg, dat de statusindicatie gedurende vijf seconden geel-rood zal knipperen; wisselen naar de modus opladen heeft tot gevolg, dat de statusindicatie gedurende vijf seconden geel-groen zal knipperen.



Ontladen wordt aangegeven door de rood knipperende statusindicatie. Als het ontladen is voltooid, zal de statusindicatie groen gaan knipperen. Dit betekend, dat de accu nu wordt geladen.

2.5

De Accu Opladen

Procedure

Stap	Omschrijving
1.	De accu-adapter inzetten.
2.	Sluit de lader aan op netstroom, de groene functie-indicatie zal oplichten.
3.	De accu inzetten. De gele statusindicatie zal knipperen om aan te geven, dat de accu is herkend.
4.	Controleer, dat de groene statusindicatie blijft branden. De accu wordt nu opgeladen. Zie hoofdstuk "2.6 Indicatielampjes", als een andere status wordt weergegeven na aansluiten van de accu.  Controleer de statusindicatie na ongeveer een minuut.
5.	De accu is volledig geladen als de groene statusindicatie begint te knipperen. Zie hoofdstuk "5 Technische Specificaties", voor informatie over oplaadtijden.
6.	De accu kan worden uitgenomen of aangesloten blijven om te garanderen, dat indien nodig altijd een volle lading beschikbaar is. Zie hoofdstuk "Oplaad Methodes" voor verdere informatie.

De laadvolgorde instellen

De GKL221 lader kan twee accu's tegelijkertijd opladen.

Als meer dan een accu op de lader is aangesloten, zal degene, die het eerst werd aangesloten ook als eerste worden geladen. Sluit altijd de meest urgente accu het eerste aan op de lader.

Prioriteiten



Accu's aangesloten op de externe accu aansluiting zullen worden geladen, zonder een reeds begonnen laadproces te onderbreken.

Een volle lading behouden

Als een accu volledig is geladen mag deze aangesloten blijven. NiCd en NiMH accu's worden om beurten geladen om hun volle lading te behouden. Op deze manier wordt de intrinsieke zelf-ontlading gecompenseerd en zal de accu altijd volledig geladen zijn en klaar voor gebruik. Zie hoofdstuk "5 Oplaad Methodes" voor verdere informatie.

Accu's Verversen



De Verversfunctie zal de accu volledig ontladen en deze daarna snelladen.

Stap	Omschrijving
1.	Sluit de lader aan op de netspanning.
2.	De accu inzetten. De gele statusindicatie zal knipperen om aan te geven, dat de accu is herkend.
3.	Druk de selectietoets langer dan drie seconden in om het ontladen van de accu te starten. Het ontladen wordt aangegeven door het rood knipperen van de statusindicatie.  Het ontladen kan lang duren voor accu's met een grote capaciteit. Om de ontladings-tijd kort te houden, deze functie alleen gebruiken met lege of bijna lege accu's.
4.	Als de accu leeg is, zal worden omgeschakeld naar snelladen. De statusindicatie licht groen op.
5.	De accu is geheel geladen als de statusindicatie groen gaat knipperen.
	Wij adviseren om NiCd en NiMH accu's twee tot driemaal te verversen als hun capaciteit merkbaar terug gaat lopen.
	Voor Li-Ion accu's is een enkele ontlad en laadcyclus voldoende. Wij adviseren dit proces uit te voeren als de aangegeven lading op de lader of op een Leica Geosystems product beduidend verschilt met de werkelijk beschikbare accu-capaciteit.



2.6

Indicatie Lampjes





Verklaring van de Symbolen



Symbol	Betekenis
	LED uit.
	LED permanent aan.
	LED knippert.

Spanningsindicatie

Symbol	LED	Betekenis
	Uit	De lader is niet aangesloten.
	Groen	De lader is op voedingsspanning aangesloten.

Status Indicatie

Symbol	LED	Betekenis
	Uit	De aangesloten accu wordt niet herkend.
	Geel	De aangesloten accu wordt herkend. De lader staat in wacht-stand, omdat reeds twee accu's worden opgeladen.
	Groen	De aangesloten accu wordt opgeladen.
	Groen	De aangesloten acu is volledig geladen en kan worden uitgenomen.
	Rood	De lader heeft een fout gedetecteerd.







Symbol	LED	Betekenis
	Rood	Er is een accu aangesloten, die moet worden ververst. De accu wordt ontladen.
	Geel	Geeft het actieve, geselecteerde slot aan.

Capaciteits en Fout-indicaties

- Bij normale werking zullen de drie capaciteits- en foutindicaties groen oplichten om de capaciteit en het geselecteerde slot aan te geven. Na het selecteren van het slot zullen de indicaties gedurende 10 à 15 seconden oplichten en vervolgens uitschakelen.
- In geval van een fout zullen de capaciteits- en foutindicaties bij het slot rood indicatie lampjes om het probleem aan te geven.

Capaciteits-indicaties











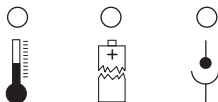



LED's	Betekenis
○ ○ ○	Acculading is minder dan 20%.
 ○ ○	Acculading is tenminste 20%.
  ○	Acculading is tenminste 50%.
  	Acculading is tenminste 80%.



Op dit moment kan het niveau van de lading alleen worden weergegeven voor de Leica Geosystems GEB211, GEB212, GEB221, GEB222, GEB241, GEB242 en GEB90 accu's.

Foutindicaties



LED's	Betekenis	Te nemen Maatregelen
  	De accu is te koud of oververhit.	Zie hoofdstuk "5 Temperatuurbereik" voor aanvullende informatie.
  	De accu is defect.	Gebruik een andere accu.
  	Slecht contact op de accu of de accu-adapter.	Controleer de contacten.
  	Hardwarefout in de lader.	Neem contact op met een geautoriseerde Leica Geosystems service werkplaats.



Als de lader een fout aangeeft bij het aansluiten van een accu:

- Sluit een andere accu aan om te controleren of de fout in de accu zit of in de lader.
- Als het probleem blijft, neem dan contact op met een geautoriseerde Leica Geosystems service werkplaats.



In geval van een fout, controleer dan ook:

- Of de aansluiting op het stopcontact of de voertuigadapter wel in orde is.
- Of alle kabels en snoeren correct aangesloten en onbeschadigd zijn.
- Of de functie-indicatie van de optionele voertuigadapter wel brandt.

2.7

Tips



Tips

-
- Om accu's tot hun volle capaciteit te laden moeten nieuwe NiCd en NiMH accu's eerst drie tot vijf keer volledig worden ontladen en geladen.
 - Laat accu's zoveel mogelijk in het instrument leegraken. Dit voorkomt het zogenaamde "memory effect" met NiCd accu's.
 - Bij gebruik van de voertuigadapter, altijd de motor draaiende houden tijdens het opladen van de accu's.
-

Vermijdt plotselinge temperatuurschommelingen tijdens het laden van accu's (bv. vermijdt direct zonlicht op de lader of de accu's). Snelle veranderingen in de omgevingstemperatuur kunnen het laadproces voortijdig beëindigen, zonder de accu's volledig te laden.

3 Verzorging en Vervoer

3.1 Vervoer

Vervoer

Als het product per spoor, vliegtuig of schip wordt vervoerd, gebruik dan steeds de originele of gelijkwaardige verpakking om het te beschermen tegen schokken en trillingen.

3.2 Opslag

Product

Bij opslag van uw uitrusting de temperatuur-grenswaarden in acht nemen, vooral in de zomer wanneer u uw uitrusting in uw auto bewaart. Zie hoofdstuk "5 Technische Specificaties" voor informatie over temperatuur-grenswaarden.

3.3 Onderhoud en Drogen

Product

Het product altijd met een zachte schone doek schoonmaken.

Kabels en Stekkers

Houdt stekkers altijd schoon en droog. Vuil in de stekkers van de aansluitsnoeren eruit blazen.

4

Veiligheidsvoorschriften

4.1

Algemene Informatie

Beschrijving

Deze aanwijzingen dienen om beheerders en gebruikers van de GKL221 in staat te stellen om tijdig op eventuele gebruiksgevaaren in te spelen en zo mogelijk te vermijden.

De beheerder moet er op toezien, dat alle gebruikers deze aanwijzingen begrijpen en opvolgen.

4.2

Gebruiksdoel

Gebruik conform de bepalingen

- Laden en ontladen van accu's gebaseerd op verschillende cel technologieën.
-

Onjuist Gebruik

- Gebruik van het laadapparaat zonder de noodzakelijke instructie;
- Toepassing buiten de gebruiksgrenzen;
- Het onklaar maken van veiligheidsvoorzieningen;
- Het verwijderen van aanwijzings- en waarschuwingsstickers;
- Openen van het instrument met gereedschap (schroevendraaier, enz.), tenzij dit nadrukkelijk is toegestaan voor bepaalde functies;
- Modificatie of aanpassing van het product;
- Gebruik na ontvreemding;
- Gebruik van producten met duidelijk zichtbare schade of defect;
- Gebruik van accessoires van andere fabrikanten zonder de nadrukkelijke toestemming vooraf van Leica Geosystems.



Waarschuwing

Bij ondeskundig gebruik bestaat gevaar voor letsel, het niet functioneren of het ontstaan van materiële schade. De beheerder informeert de gebruiker omtrent gevaren bij gebruik van het product en over de veiligheidsmaatregelen.

Het product mag pas in gebruik worden genomen, nadat de gebruiker de betreffende instructies heeft ontvangen.

4.3

Beperkingen in het Gebruik

Omgeving

Alleen geschikt voor gebruik in droge ruimtes en niet onder moeilijke omstandigheden

4.4

Verantwoordelijkheden

De Fabrikant

Leica Geosystems AG, CH-9435 Heerbrugg, hierna genoemd Leica Geosystems, is verantwoordelijk voor de veiligheidstechnisch perfecte levering van het product inclusief gebruiksaanwijzing en originele accessoires.

Andere Fabrikanten

Fabrikanten van niet-Leica Geosystems accessoires zijn verantwoordelijk voor het ontwikkelen, invoeren en communiceren van veiligheids-concepten voor hun producten en voor het functioneren daarvan in combinatie met het Leica Geosystems product.

Beheerder van het product

De beheerder van het instrument heeft de volgende verplichtingen:

- Hij begrijpt de veiligheids-informatie op het product en de instructies in de gebruiksaanwijzing;
- Hij is bekend met de plaatselijke voorschriften met betrekking tot veiligheid en preventie van ongelukken;
- Hij stelt Leica Geosystems er onmiddellijk van op de hoogte zodra veiligheidsgebreken aan de uitrusting optreden.

Waarschuwing

De beheerder is er verantwoordelijk voor dat het instrument conform de voorschriften wordt gebruikt. Deze persoon moet tevens zorgdragen voor een goede training en inzet van het personeel, dat het product gebruikt en voor de veilige toepassing van de apparatuur.

4.5

Gebruiksrisico's

Waarschuwing

Ontbrekende of onvolledige instructies kunnen leiden tot een onjuiste bediening of ondeskundig gebruik. Daarbij kunnen zich ongelukken voordoen met ernstig lichamelijk letsel, aanzienlijke materiële en financiële schade en schade aan het milieu.

Voorzorgsmaatregel:

Alle gebruikers volgen de veiligheidsaanwijzingen van de fabrikant en de instructies van de beheerder op.

Waarschuwing

Het laadapparaat is niet ontworpen voor gebruik onder vochtige en ongunstige omgevings factoren. U kunt een elektrische schok krijgen wanneer vocht het toestel binnendringt.

Voorzorgsmaatregel:

Gebruik het laadapparaat alleen in een droge omgeving en bescherm het tegen vocht. Als de lader vochtig is mag deze niet worden gebruikt!.

Waarschuwing

Als u het laadapparaat openmaakt, kunnen de volgende oorzaken leiden tot een elektrische schok:

- Aanraken van onder spanning staande onderdelen;
- Gebruik na een ondeskundige poging tot reparatie.

Voorzorgsmaatregel:

Het laadapparaat niet openmaken. Uitsluitend door Leica Geosystems geautoriseerde werkplaatsen zijn bevoegd deze producten te repareren.

Waarschuwing

Niet door Leica Geosystems aanbevolen accu's kunnen tijdens het laad- of ontladproces beschadigd raken. Zij zouden kunnen ontbranden of exploderen.

Voorzorgsmaatregel:

Laad en ontlad uitsluitend accu's, aanbevolen door Leica Geosystems.

Waarschuwing

Bij het ondeskundig verwijderen van het instrument kan het volgende zich voordoen:

- Het verbranden van polymeren onderdelen kan giftige gassen produceren, die de gezondheid kunnen schaden.
- Als accu's beschadigd raken of sterk worden verwarmd, dan kunnen zij exploderen en vergiftiging, brand, corrosie of besmetting van het milieu veroorzaken.
- Verwijdering van het instrument op een onverantwoorde wijze kan tot gevolg hebben, dat onbevoegden door incorrect gebruik de wet overtreden. Hierdoor kunnen zij zichzelf en derden blootstellen aan ernstige verwondingen en het milieu vervuilen.

Voorzorgsmaatregel:



Het product mag niet samen met het huisvuil worden weggegooid.

Het verwijderen van het instrument moet in overeenstemming zijn met de geldende regels in uw land.

Bescherm het instrument te allen tijde tegen het gebruik door onbevoegden.

Productspecifieke informatie over behandeling en afvalverwerking kan worden gedownload van de Leica Geosystems home page op <http://www.leicageosystems.com/treatment> of worden verkregen via uw Leica Geosystems dealer.

4.6

Elektromagnetische Verdraagbaarheid

Omschrijving

Onder elektromagnetische verdraagbaarheid wordt verstaan de mogelijkheid van het product om zonder problemen te functioneren in een omgeving met elektromagnetische straling en elektrostatische ontladingen, zonder daarbij storingen in andere apparaten te veroorzaken.

Waarschuwing

Elektromagnetische straling kan storingen veroorzaken in andere apparatuur.

Hoewel het product voldoet aan strenge normen en richtlijnen op dit gebied, kan Leica Geosystems de mogelijkheid van storing in andere apparatuur niet volledig uitsluiten.

Voorzichtig

Kan storingen veroorzaken in andere apparatuur bij gebruik in combinatie met onderdelen van andere leveranciers, bijvoorbeeld kabels of externe accu's.

Voorzorgsmaatregel:

Gebruik uitsluitend apparatuur en accessoires aanbevolen door Leica Geosystems. Bij gebruik in combinatie met het product voldoen deze aan de strengste eisen.

Waarschuwing

Gebruik van het product terwijl kabels slechts aan een zijde zijn aangesloten (bijvoorbeeld accu-aansluitnoeren), kan het niveau van elektromagnetische straling boven de toegestane grenzen uit laten stijgen en storingen veroorzaken in andere apparatuur.

Voorzorgsmaatregel:

Als het product in gebruik is moeten beide zijden van kabels zijn aangesloten.

4.7

FCC Verwijzing, geldig in de VS

Waarschuwing

Dit apparaat heeft in tests de grenswaarden aangehouden voor digitale apparaten uit de klasse B, die zijn gedefinieerd in paragraaf 15 van de FCC-bepalingen.

Deze eisen zijn ontworpen om bescherming te bieden tegen schadelijke invloeden van installatie in de woonomgeving.

Dit product genereert en gebruikt stralingsenergie en kan deze uitzenden indien niet geïnstalleerd en gebruikt volgens de voorschriften. Dit kan schadelijke storingen veroorzaken bij radio-communicatie.

Als dit product schadelijke storingen veroorzaakt in radio of televisieontvangst, hetgeen kan worden vastgesteld door het product uit en aan te schakelen, wordt de gebruiker de onderstaande maatregelen aanbevolen om te pogen de storing te elimineren:

- De ontvangstantenne opnieuw richten of verplaatsen;
 - De afstand tussen apparaat en ontvanger vergroten;
 - Het apparaat aansluiten op een stopcontact van een andere stroomkring, dan die waarop de ontvanger is aangesloten;
 - Raadpleeg uw dealer of een ervaren radio/TV technicus.
-

Waarschuwing

Wijzigingen of modificaties die niet uitdrukkelijk door Leica Geosystems zijn toegestaan, kunnen het recht van de gebruiker beëindigen om het apparaat te gebruiken.

Etiketten

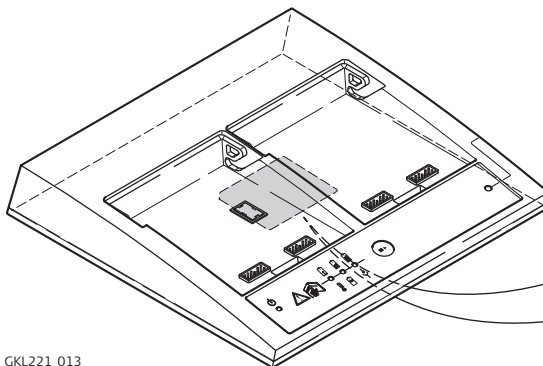

GKL221_013

Type: GKL221

Art.No.:

.....
.....
.....
.....
.....
.....
.....
This device complies with part 15 of the FCC Rules. Operation is subject to the following two conditions: (1) This device may not cause harmful interference, and (2) this device must accept any interference received, including interference that may cause undesired operation.

5

Technische Specificaties

Stroomvoorziening	<ul style="list-style-type: none">• Netspanning, ~• Gelijkstroomaansluiting, ==
Aansluitspanning	<ul style="list-style-type: none">• 100 - 240 VAC, 50/60 Hz• 24VDC
Laadvermogen	Maximum 18 VDC / maximum 4.0 A; afhankelijk van type accu
Ontladen	4 W
Vermogen	~ : 75 W == : 55 W
Werkomgeving	Alleen gebruiken in droge ruimten, bijvoorbeeld in gebouwen of voertuigen IP40, volgens IEC60529
Temperatuurbereik	Opslag: -40°C tot +70°C -40°F tot +158°F Bediening: ~ : 0°C tot +40°C +32°F tot 104°F == : 0°C tot +50°C +32°F tot 122°F
Oplaad Methoden	Snellaad methode voor: <ul style="list-style-type: none">• Alle Leica Geosystems accu's. Deze biedt het monitoren van de temperatuur en herkennen van accutype. Laadstroom is maximaal 4.0 A, afhankelijk van de accu.• Alle standaard camcorder accu's met drie contacten en temperatuur-monitoring. Laadstroom maximaal 1.6 A Normaal laad methode voor: <ul style="list-style-type: none">• NiCd en NiMH accu's bij temperaturen onder +10°C.• Li-Ion accu's bij temperaturen onder +6°C• Bijna of geheel lege Li-Ion, NiCd en NiMH accu's.



Laadtechnologie

Conserverings laad methode voor:

- NiCd en NiMH accu's. Laadstroom is afhankelijk van het type accu. Laden gebeurt om de beurt steeds circa 15 seconden per accu.

Voor Li-Ion accu's is conserveringsladen niet nodig, omdat zij hun lading niet verliezen als ze niet worden gebruikt.

Regels voor uitschakelen tijdens snelladen:

Voor NiCd en NiMH accu's:

Tijdschakelaar
Capaciteit
Accutemperatuur
Negatief spanningsverschil
Temperatuur toename per minuut
Dubbele inflectie methode

Voor Li-Ion accu's:

Tijdschakelaar
Capaciteit
Accutemperatuur
Laadstroom

Conserveringsladen van NiCd en NiMH accu's:

Bewaakt accuspanning, laadstroom en accutemperatuur.

Accu Type

- NiCd
- NiMH
- Li-Ion

Oplaad- en Ontladingsstijden

De tijdsduur van opladen en ontladen is grotendeels afhankelijk van de laad- of ontlaadstroom, de capaciteit van de accu en de lading op het moment van aansluiten.

De volgende richtlijnen kunnen worden gegeven:

Snelladen bij 20°C:

NiCd accu's

max 2200 mAh 1.0 tot 1.5 uur

max 7200 mAh 2.5 tot 4.0 uur

NiMH accu's

max 2200 mAh 1.5 tot 2.0 uur

max 4900 mAh 2.0 tot 2.5 uur

max 10000 mAh 2.5 tot 5.5 uur

Li-Ion accu's

max 4600 mAh 2.5 tot 3.5 uur

Ontladen:

Voor NiCd en NiMH accu's

6V accu's met 600 mAh per uur

12V accu's met 300 mAh per uur

Li-Ion accu's

7.4V accu's met 500 mAh per uur

Signaleringen

Zie hoofdstuk "2.6 Indicatie Lampjes".

Gewicht

Lader inclusief twee accu-adapters: 1.12 kg

Afmetingen

B x D x H: maximaal 237 mm x 227 mm x 43 mm; inclusief de accu-adapter

Leica GKL221 Laddstation

Bruksanvisning

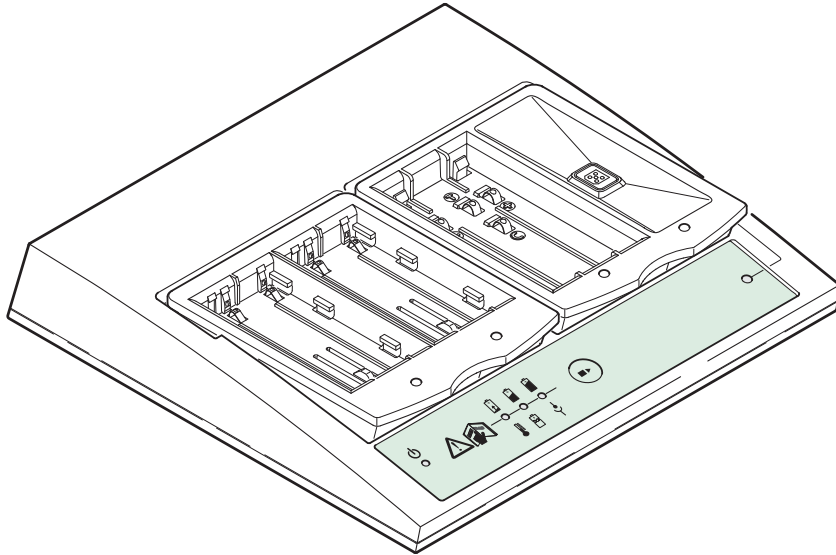

Version 1.3
Svenska

- when it has to be **right**

Leica
Geosystems

Inledning



Denna bruksanvisning innehåller instruktioner för användande av instrumentet samt viktiga säkerhetsanvisningar. Se kapitel "4 Säkerhetsföreskrifter" för ytterligare information. Läs noggrant igenom bruksanvisningen innan du startar instrumentet.

Produktidentifiering





Typbeteckning och serienummer för produkten finns på typskylten. Notera dessa uppgifter i Er bruksanvisning och använd alltid dessa uppgifter när Ni vänder Er till vår återförsäljare eller en av Leica Geosystems auktoriserad kundtjänst.

Typ: _____

Serienr.: _____

Använda symboler

Symbolerna i denna bruksanvisning har följande innebörd:

Symbol	Beskrivning
 Fara	Indikerar en farlig situation vilken omedelbart resulterar i svåra skador för användaren eller användarens död.
 Varning	Indikerar en potentiellt farlig situation vilken, om den inte undviks, kan resultera i svåra skador för användaren eller användarens död.
 Försiktigt	Indikerar en potentiellt farlig situation vilken, om den inte undviks, kan resultera i mindre skador för användaren, men avsevärd materiell och finansiell skada samt miljömässig påverkan.
	Viktiga avsnitt, som bör följas vid praktisk hantering, därför att de möjliggör att produkten används på ett tekniskt korrekt och effektivt sätt.

Innehållsförteckning

Innehåll	Tema	Sidan
1	Systembeskrivning	4
2	Hantering	8
	2.1 Batteriadapter	8
	2.2 Ansluta laddstation	9
	2.3 Sätta in och ta ur batterier	11
	2.4 Funktionsknapp	14
	2.5 Ladda batteri	15
	2.6 Signallampor	17
	2.7 Tips	20
3	Underhåll och transport	21
	3.1 Transport	21
	3.2 Förvaring	21
	3.3 Rengöring och skötsel	21
4	Säkerhetsföreskrifter	22
	4.1 Generellt	22
	4.2 Användningsområde	22
	4.3 Begränsningar i användningen	23
	4.4 Ansvarsförhållanden	23
	4.5 Risker vid användande	23
	4.6 Elektromagnetisk acceptans	25
	4.7 FCC- anvisningar (gäller i U. S. A.).	26
5	Tekniska data	28

1

Systembeskrivning

Beskrivning

GKL221 från Leica Geosystems är en intelligent laddstation med innovativ laddningsteknik. Produkten är avsedd för laddning av alla Leica Geosystems batterier via vanligt elnät eller fordon via fordonssadapter GDC221. Laddstationen är ett perfekt tillbehör till batteridrivna produkter från Leica Geosystems.

Allmän information

Upp till fem batterier kan anslutas till laddstationen. Två batterier kan laddas samtidigt. Batterierna laddas i den ordning de ansluts. Laddstationen har följande funktioner utöver laddning: Urladdning, underhållsladdning eller snabb-laddning.



Läs denna bruksanvisning och bekanta dig med produkten samtidigt.

De olika delarna

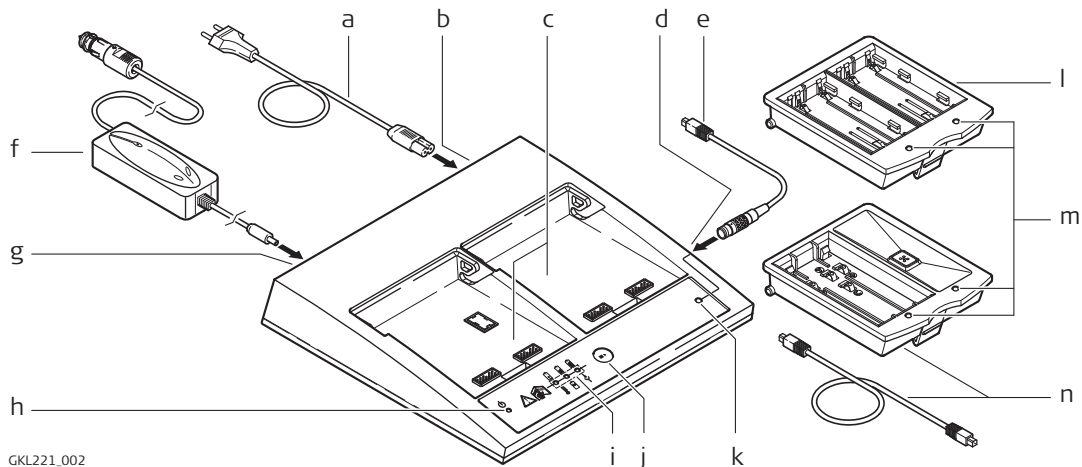

GKL221_002

- a) Nätkabel
- b) Anslutning för nätkabel
- c) Schakt I och II för batteriadapter GDI221 / GDI222
- d) Extern batterianslutning
- e) Laddkabel för externt 5-poligt batteri
- f) Fordonsadapter GDC221, tillval
- g) Anslutning för fordonsadapter
- h) Driftslampa
- i) Kapacitets- och fellampa
- j) Funktionsknapp
- k) Tillståndslampa för extern batterianslutning
- l) Batteriadapter GDI221, tillval
- m) Tillståndslampor för batteri
- n) Batteriadapter GDI222 och passande 5-polig laddkabel, tillval

SV

Laddbara batterier

Följande batterier från Leica Geosystems kan laddas:

GEB90
GEB211
GEB212
GEB221
GEB222
GEB241
GEB242



GEB111
GEB121

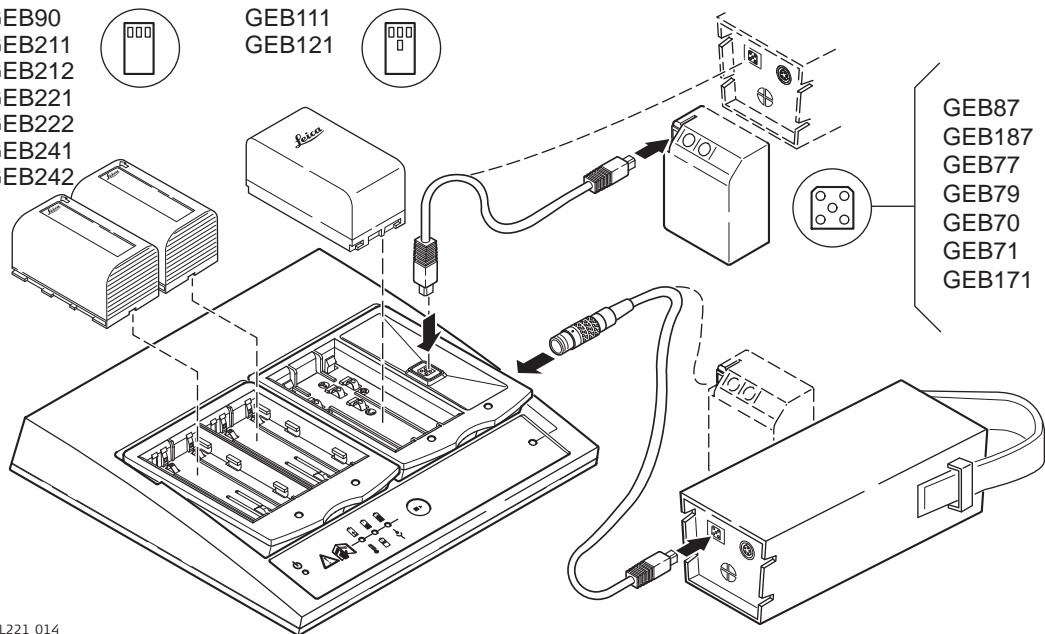

GKL221_014



Laddstationen är avsedd för laddning och urladdning av originalbatterier från Leica Geosystems samt olika, i handeln förekommande NiMH/NiCd Camcorderbatterier. Se kapitel "2.3 Sätta in och ta ur batterier" för ytterligare information.

Laddstation och batteri-adapter

Kombination av laddstation och batteriadapter möjliggör anslutning och laddning av följande batterier:

Laddstation / batteriadapter	Laddbara batterier
GKL221 med två GDI221	Upp till fyra li-ion-batterier och ett batteri med 5-polig laddkontakt.
GKL221 med en GDI221 och en GDI222	Två li-ion-batterier, ett batteri i camcorderformat och två batterier med 5-polig laddkontakt.
GKL221 med två GDI222	Två batterier i camcorderformat och tre batterier med 5-polig laddkontakt.

2

2.1

Hantering

Batteriadapter

Funktion

Batteriadaptern används för anslutning av batterierna till laddstationen. En lampa per laddningsschakt visar batteriets laddningstillstånd.

Typ

Alla batteriadapterar finns tillgängliga:

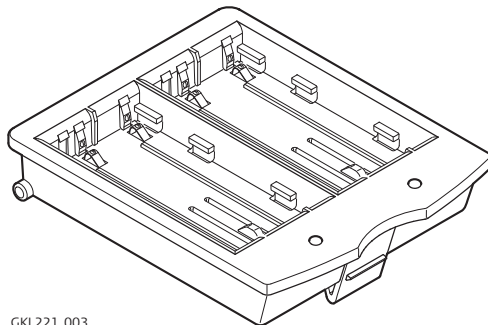

GKL221_003

GDI221

- För två Leica Geosystems Li-ion-batterier GEB90, GEB211, GEB212, GEB221, GEB222, GEB241 eller GEB242.

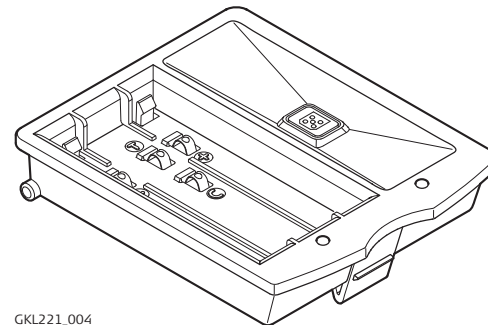

GKL221_004

GDI222

- För ett Leica Geosystems NiMH-batteri GEB111 eller GEB121 och ett NiCd eller NiMH 5-poligt batteri.

Sätta in, ta ur

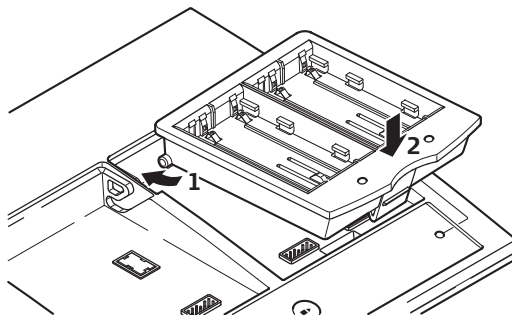

GKL221_005

Sätta in

1. Sätt i batteriadaptern med den bakre delen först.
2. Tryck in den främre delen tills den hakar i. Det skall höras och kännas att det hakar i.

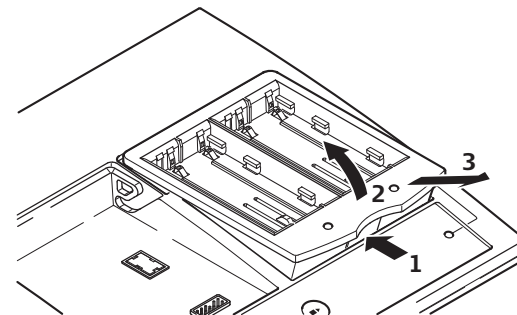

GKL221_006

Ta ur

1. Tryck ner den främre kanten.
2. Dra lätt uppåt.
3. Dra ut adaptern framåt.

2.2

Ansluta laddstation

SV



Varning

Användning

Använd endast laddstationen i torr omgivning! Fuktiga eller immiga instrument får inte användas!

Kontrollera att produkten står stadigt för användningen.

Anslut laddstationen antingen:

- med levererad nätkabel till vägguttag eller
- med fordonskabeln (tillbehör) GDC211 till fordonets cigarettändaruttag.



För att säkert skilja stationen från strömkällan, när det inte används under längre tid, skall nätkabel, resp. fordonskabel dras ut ur resp. kontakt.



Laddstationens fordonskabel får endast matas från fordonets batteri. Vid anslutning till andra strömkällor (t.ex. via strömbegränsande nätaggregat/batterieliminators) kan felfunktioner förekomma. Se kapitel "5 Tekniska data" för information om ingångsspänning och effekt.



Se till att polerna sitter rätt i cigarettändaruttaget (pluspolen i mitten). Om polningen inte är korrekt, måste laddstationens säkring eller fordonsuttagets säkring bytas. Utbytet av säkring på laddstationen måste utföras av auktoriserade servicepersonal från Leica Geosystems. Bytet av säkringen i fordonsuttaget måste göras enligt fordonets bruksanvisning.

Funktionskontroll

Efter anslutningen till vägguttaget eller till fordonet lyser adaptorns lampor, rött, gult och grönt, kapacitets- och fellamporna lyser rött och grönt. Detta är en funktionskontroll.

Om inga batterier finns anslutna, lyser driftslampan grön.

Om signallamporna och de tre kapacitets- och fellamporna lyser rött hela tiden är produkten defekt. Se kapitel "2.6 Signallampor" för ytterligare information.

2.3

Sätta in och ta ur batterier

Li-ion-batterier

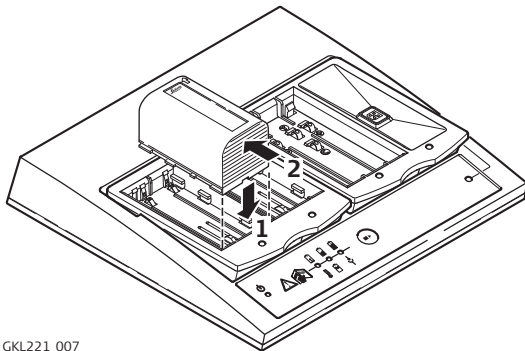

GKL221_007

Sätta in:

1. Lägg in batteriet i kant med batterischaktets, GDI221 framkant.
2. Tryck in batteriet med en lätt tryckning.

Ta ur:

- Dra ut batteriet tills det tar emot och ta ur det.

Varning

Använd endast laddstationen för att ladda resp. ladda ur batterier som rekommenderas av Leica Geosystems. Använd endast li-ion-batterier från Leica Geosystems.

SV

NiCd och NiMH-batterier

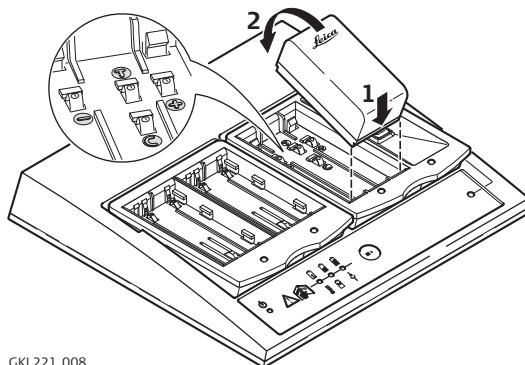

GKL221_008

Sätta in:

1. Lägg in batteriet i batterischaktets, GDI222 framkant.
2. Tryck nedåt, det skall höras och kännas att det hakar i.

Ta ur:

- Ta tag i batteriets bakkant och dra uppåt.



Leica Geosystems-batterierna GEB111 och GEB121 har fyra kontaktytor, Camcorderbatterier från andra tillverkare endast tre. Laddstationen kan skilja mellan dessa batterityper och anpassar laddningen därefter.



Camcorderbatterier med tre kontaktytor skall uppfylla följande krav för att undvika skador:

- Spänning: 6 V
- Batterityp: NiCd eller NiMH
- Minimikapacitet: NiCd 1500 mAh, NiMH 1800 mAh
- Kompatibla kontakter i korrekt ordning, d.v.s "+, T, -" i följd.

De Camcorderbatterier som uppfyller dessa krav laddas med temperaturövervakning och laddström 1.6 A.

Batterier med 5-polig laddkontakt

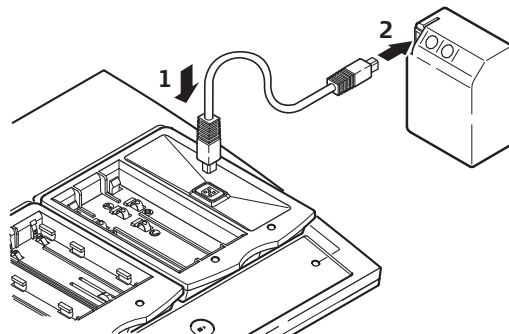

GKL221_009

Leica Geosystems Batterier med 5-polig laddkontakt, t.ex. GEB87 eller GEB70 ansluts med laddkabel till den 5-poliga laddkontakten.

Externa batterier med 5-polig laddkontakt

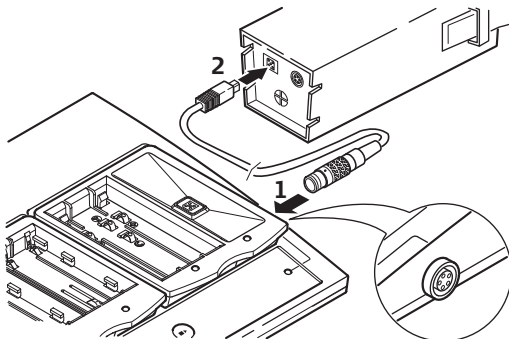

GKL221_010

Leica Geosystems Batterier med 5-poliga laddkontakt, t.ex. GEB87 eller GEB70 ansluts med laddkabel till den externa batterianslutningen.

 Batterier till den externa batterianslutningen skall i första hand laddas utan att en redan påbörjad laddning avbryts.

SV

2.4

Funktionsknapp

Funktion

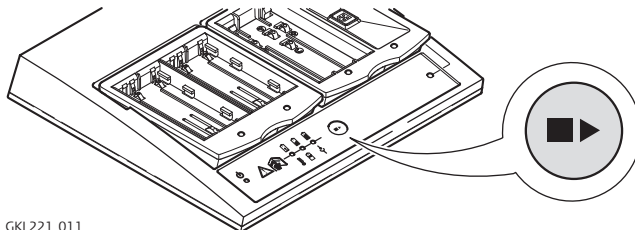

GKL221_011

Funktionsknappen används för att välja laddschakt eller att växla mellan laddning och urladdning.

Funktion	Tryck funktionsknapp	Beskrivning
Välj laddschakt	Mindre än två sekunder	Nästa schakt med batteri aktiveras. Lampan blinkar gul i ca. tre sekunder för att bekräfta att schaktet aktiverats och batteriets kapacitet visas.
Växla mellan laddning och urladdning	Längre än tre sekunder	Lampan blinkar gul-röd när du byter till urladdningsläge men gul-grön när du byter till laddningsläge. Lampan blinkar ca. fem sekunder vardera.



Urladdning visas med röd blinkande lampa. När urladdningen är avslutad, växlar lampan till grön, d.v.s batteriet laddas.

2.5

Ladda batteri

Tillvägagångssätt

Steg	Beskrivning
1.	Sätt i batteriadaptern.
2.	Anslut laddstationen till strömförsörjningen, lampan lyser grön.
3.	Lägg i batteriet. Lampan blinkar gul, d.v.s laddstationen har känt av batteriet.
4.	Kontrollera att lampan lyser grön kontinuerligt. Batteriet laddas. Se kapitel "2.6 Signallampor" om lampan skulle visa annorlunda när batteriet läggs i.  Kontrollera lampan efter ca. en minut igen.
5.	Batteriet är fulladdat när den gröna lampan blinkar. Se kapitel "5 Tekniska data" för information om laddningstider.
6.	Batteriet kan tas ur eller ligga kvar i laddstationen så att det finns tillgängligt vid behov. Se kapitel "Laddningssätt" för ytterligare information.

Bestämma ordningsföljd

Laddstation GKL221 kan ladda två batterier samtidigt. Batterierna laddas i den ordning de ansluts till laddstationen. Anslut därför det batteri först som behöver laddas mest.

Prioritet

Batterier till den externa batterianslutningen skall i första hand laddas utan att en redan påbörjad laddning avbryts.



Underhållsladdning

Om de anslutna batterierna är fulladdade kan de ligga kvar i laddstationen. En sekvensiell underhållsladdning görs för NiCd och NiMH-batterier. Därmed kompenseras batteriernas självurladdning och de är alltid fulladdade. Se kapitel "Laddningssätt" för ytterligare information.

SV

Snabbladda batteri



Snabbladdningsfunktionen består av en fullständig urladdning och sedan snabbladdning.

Steg	Beskrivning
1.	Anslut laddstationen till strömförsörjningen.
2.	Lägg i batteriet. Lampan blinkar gul, d.v.s laddstationen har känt av batteriet.
3.	Tryck funktionsknappen längre än tre sekunder, urladdningen av valt batteri börjar. Urladdningen visas genom röd blinkande lampa.  Urladdningen kan ta längre tid med stora batterier. Funktionen bör därför användas för tomma eller nästan tomma batterier för att förkorta urladdningstiden.
4.	När batteriet är helt urladdat, börjar snabbladdningen automatiskt. Lampan lyser grön.
5.	Batteriet är fulladdat när den gröna lampan blinkar.
	Vi rekommenderar att snabbladdningsfunktionen används två eller tre gånger för NiCd och NiMH-batterier när kapaciteten sjunkit märkbart.
	En urladdning och en laddning räcker för li-ion-batterier. Vi rekommenderar att genomföra detta när den kapacitet som visas för batteriet på laddstationen eller annan Leica Geosystems- produkt avviker mycket från normal kapacitet.



2.6

Signallampor





Symbolförklaringar

Symbol	Betydelse
	LED av.
	LED lyser permanent.
	LED blinkar.



Driftslampa

Symbol	LED	Betydelse
	Av	Laddstationen är inte ansluten till strömkälla.
	Grön	Laddstationen är ansluten till strömkälla.

Tillståndslampor

Symbol	LED	Betydelse
	Av	Inget batteri detekterat.
	Gul	Batteri detekterat i laddstation. Vänteläge, två andra batterier laddas eller laddas ur för tillfället.
	Grön	Det anslutna batteriet laddas.
	Grön	Det anslutna batteriet är fulladdat och kan tas ur.
	Röd	Laddstationen har känt av ett fel.

SV





Symbol	LED	Betydelse
	Röd	Batteriet är anslutet för snabbladdning. Det laddas ur för tillfället.
	Gul	Visar aktivt schakt.

Kapacitets- och fellampor

- Vid normal användning visar de tre kapacitets- och fellampor batteriets kapacitet i valt schakt med hjälp av grön lampa. Lampan visas när schaktet aktiveras ca. tio till femton sekunder, sedan slocknar den.
- Vid felfunktion visar kapacitets- och fellamporna felkoden för val schakt med hjälp av röd lampa.

Kapacitetslampa











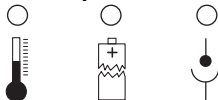



LEDs	Betydelse
	Batteriets laddning är lägre än 20%.
	Batteriets laddning är minst 20%.
	Batteriets laddning är minst 50%.
	Batteriets laddning är minst 80%.



Kapacitetslampa finns för tillfället endast för Leica Geosystems-batterier GEB90, GEB211, GEB212, GEB221, GEB222, GEB241 och GEB242.

Fellampor



LEDs	Betydelse	Åtgärd
  	Batteriet uppvisar ett temperaturfel.	Se kapitel "Temperaturområde" för ytterligare information.
  	Batteriet är defekt.	Använd ett annat batteri.
  	Felaktig kontakt på batteri eller batteriadapter.	Kontrollera kontakterna.
  	Hårdvarufel i laddstation.	Kontakta Leica Geosystems auktoriserade kundtjänst.



Om laddstationen uppvisar ett fel vid anslutet batteri:

- Anslut ett annat batteri för att kontrollera om störningen finns i batteriet eller i laddstationen.
- Om problemet återkommer, kontakta Leica Geosystems auktoriserade kundtjänst.



Kontrollera även följande vid felfunktioner:

- Är strömförsörjningen via vägguttaget eller fordonsbatteriet tillräcklig?
- Är kablarna ordentligt anslutna eller är kablarna skadade?
- Anslutning via fordonskabel:
Lyser driftslampan på fordonsadaptern?

2.7

Tips



Tips

-
- Ladda och ladda ur NiCd och NiMH-batterier fullständigt tre till fem gånger för att förbättra kapaciteten.
 - Låt batterierna sitta i instrumenten tills de är nästan urladdade. Detta undviker den s.k. minneseffekten i NiCd- batterier.
 - Vid användning av fordonskabel skall batterierna endast laddas med fordonets motor igång.
-

Undvik snabbt ökande temperatur under laddningen, t.ex. genom direkt solljus. Temperaturökning under laddningen kan medföra att laddningen avbryts för tidigt och kapaciteten reduceras.

3

Underhåll och transport

3.1

Transport

Försändelse

Använd Leica- Geosystems originalförpackning (transport- behållare eller kartong) vid försändelse med järnväg, flyg eller båt.
Förpackningen skyddar produkten mot stötar och vibrationer.

3.2

Förvaring

Produkt

Tänk alltid på gränsen för förvaringstemperaturer när utrustningen förvaras i bilen, speciellt under sommartid. Se kapitel "5 Tekniska data" för information om förvaringstemperaturer.

3.3

Rengöring och skötsel

Produkt

Torka av produkten med ren och mjuk duk.

Kablar och kontakter

Håll kontakterna rena och torra. Blås bort eventuell smuts som samlats i kabelkontakterna.

SV

4

Säkerhetsföreskrifter

4.1

Generellt

Beskrivning

Följande föreskrifter är avsedda att underlätta för personal, ansvarig för och de som använder instrumentet att undvika riskfyllda arbetssätt.

Personal med instrumentansvar måste försäkra sig om att alla användare förstår och följer dessa föreskrifter.

4.2

Användningsområde

Avsedd användning

- Laddning och urladdning av batterier av olika cellteknik.

Icke avsedd användning

- Användande av produkten utan instruktion
- Användning utanför avsedda gränser
- Inaktivering av säkerhetsanordningar.
- Avlägsnande av anvisnings- eller varningstexter
- Öppnande av produkten med hjälp av verktyg (t.ex. skruvmejsel) såvida inte annat uttryckligen tillåts i bestämda fall
- Ombyggnad eller förändring av instrumentet
- Användning efter stöld
- Användning av produkt med uppenbara brister eller skador
- Användning av tillbehör från annan tillverkare än Leica utan Leica Geosystems medgivande.



Varning

Icke avsedd användning kan leda till skada eller felfunktion.

Det åligger den instrumentansvarige att informera användaren om risker och hur man undviker dessa. Produkten får endast användas sedan användaren instruerats.

4.3 Begränsningar i användningen

Miljö Användning får endast ske i torra utrymmen inomhus och i miljömässigt goda förhållanden.

4.4 Ansvarsförhållanden

Produktens tillverkare Leica Geosystems AG, CH-9435 Heerbrugg, förkortat Leica Geosystems ansvarar för en säkerhetsteknisk och felfri levererad produkt, inklusive bruksanvisning och originaltillbehör.

Tillverkare av främmande tillbehör Annan tillverkare av tilläggsutrustning för produkten är ansvarig för utveckling och implementering samt information om sina produkters säkerhet samt för effektiviteten i dessa delar i kombination med Leica Geosystems produkter.

Användare Instrumentansvarig har följande skyldigheter:

- Att förstå säkerhetsinstruktionerna för produkten och instruktionerna i handboken.
- Att känna till lokala säkerhets- och arbetarskyddsföreskrifter.
- Att informera Leica Geosystems omedelbart om produkten och dess funktion uppvisar fel vilka påverkar säkerheten.

Varning

Instrumentansvarig måste försäkra sig om att produkten används i enlighet med instruktionerna. På instrumentansvarig åligger också att träna och utbilda personal som ska använda produkten samt ansvara för dess driftssäkerhet.

4.5 Risker vid användande

Varning

Utebliven eller ej komplett instruktion kan leda till felaktig eller otillåten användning. Därmed ökas riskerna för svåra olyckor med person-, sak-, förmögenhets- och miljöskador som följd.

För säkerhets skull:

Alla användare måste följa tillverkarens säkerhetsföreskrifter och instrumentansvariges anvisningar.

 **Varning**

Produkten är inte konstruerat för användning i blöta eller fuktiga omgivningar. Om fukt tränger in, finns risk att användaren utsätts för stötar.

För säkerhets skull:

Använd endast produkten inomhus i torr omgivning t.ex. byggnad eller fordon. Skydda produkten mot fukt. Fuktiga eller blöta produkter får inte användas!

 **Varning**

När produkten öppnas, kan du få en elektrisk stöt av följande anledningar:

- Beröring av strömförande komponenter
- Användning efter otillåtet reparationsförsök.

För säkerhets skull:

Öppna inte produkten. Tillåt endast auktoriserad Leica Geosystems kundtjänst utföra reparation.

 **Varning**

Vid laddning eller urladdning av batterier, icke rekommenderade av Leica Geosystems kan batterierna skadas. Detta kan medföra brand- och explosionsrisk.

För säkerhets skull:

Ladda aldrig eller ladda aldrig ur batterier som inte rekommenderas av Leica Geosystems.

 **Varning**

Om produkten avfallshanteras på ett felaktigt sätt kan följande inträffa:

- Om plastdelar bränns, kan giftiga gaser bildas vilka kan orsaka hälsorisker.
- Om batterierna skadas eller upphettas kan de explodera och förorsaka förgiftning, brand, frätskador annan miljöpåverkan.
- Genom vårdslös avfallshantering möjliggörs obehöriga personer att använda produkten på icke avsett sätt. Detta kan medföra svåra skador för dig själv, tredje man eller miljön.

För säkerhets skull:

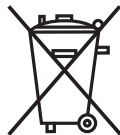

Produkten får inte avfallshanteras som hushållssopor.

Se till att produkten avfallshanteras på ett sådant sätt att lokala och nationella regler efterlevs.

Se alltid till att obehöriga inte får tillgång till produkten.

Information om avfallshantering kan laddas hem från Leica Geosystems webbplats på <http://www.leica-geosystems.com/treatment> eller erhållas hos din Leica Geosystems återförsäljare.

4.6

Elektromagnetisk acceptans

Beskrivning

Med begreppet "elektromagnetisk acceptans " menas kapacitet att fungera i en omgivning, där elektromagnetiska fält och elektrostatiska urladdningar finns, utan att ha elektromagnetisk inverkan på annan utrustning.

Varning

Elektromagnetisk strålning kan förorsaka störningar i annan utrustning.

Trots att produkten uppfyller gällande regler och normer kan Leica Geosystems inte utesluta möjligheten för inverkan på annan utrustning.

Försiktigt

Risk finns för störningar i annan utrustning när produkten används tillsammans med tillbehör från andra tillverkare, t ex. kablar eller externa batterier.

För säkerhets skull:

Använd endast produkten tillsammans med tillbehör rekommenderade av Leica Geosystems. Dessa klarar i kombination med produkten, kraven på gällande regler och normer.

Varning

Om produkten används med kabel, endast ansluten till en sida, t.e.x. extern matarkabel, kan strålningsvärdena för elektromagnetisk acceptans överstigas och annan utrustning ev. störas.

För säkerhets skull:

Anslut båda kontakterna för kabeln, t.ex. laddstation / externt batteri.

4.7

FCC- anvisningar (gäller i U. S. A.).

Varning

Denna produkt är testad och motsvarar de gränsvärden som fastställts i FCC-bestämmelserna för digitala instrument, klass B, avsnitt 15.

Dessa gränsvärden utgör tillräckligt skydd för strålning vid installation i bebyggt område.

Produkter av denna typ producerar och använder höga frekvenser och kan även utstråla desamma.

Vid inkorrekt installation och användning kan därför störning av radiomottagning förekomma.

Det kan inte garanteras att störning ändå förekommer vid vissa installationer.

Skulle instrumentet orsaka störningar vid radiomottagning, vilket man kan konstatera genom att slå av och på instrumentet, har användaren att vidta följande åtgärder för att häva störningen:

- Justera eller flytta mottagningsantennen.
 - Förstora avståndet mellan instrument och mottagare.
 - Använd inte samma elektriska uttag för instrument och mottagare.
 - Sök hjälp hos din återförsäljare eller radio- och TV-tekniker.
-

Varning

Ändringar och modifikationer, utan Leica Geosystems uttryckliga tillstånd, kan inskränka användarens rätt att använda produkten.

Produktetikettering

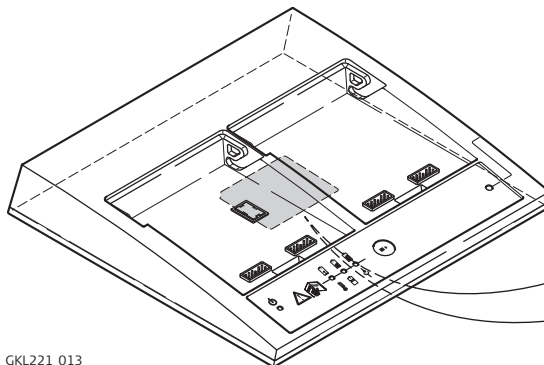

GKL221_013

Type: GKL221

Art.No.:

.....
.....
.....
.....
.....
.....
.....
.....

This device complies with part 15 of the FCC Rules. Operation is subject to the following two conditions: (1) This device may not cause harmful interference, and (2) this device must accept any interference received, including interference that may cause undesired operation.

SV

5

Tekniska data

Anslutning	<ul style="list-style-type: none">• Nätanslutning, ~• Likspänningsanslutning, ==
Ingångsspänning	<ul style="list-style-type: none">• 100- 240 V, 5060 Hz• 24V
Laddningseffekt	max.18 V / max. 4.0 A; beroende på batterityp
Urladdningseffekt	4 W
Märkeffekt	~ : 75 W == : 55 W
Användningsområde	Får endast användas i torra utrymmen, t.ex. byggnad, fordon IP40 enl. IEC60529
Temperaturområde	Förvaring: -40°C till +70°C Drift: ~ : 0°C till +40°C == : 0°C till +50°C
Laddningssätt	Snabbladdning: <ul style="list-style-type: none">• Alla Leica Geosystems batterier. Batterierna är utrustad med temperaturövervakning och batteridektering. Laddström max. 4.0 A, beroende på batteri.• Alla standard Camcorderbatterier med tre kontaktytor och temperaturövervakning. Laddström max. 1.6 A Långsam laddning: <ul style="list-style-type: none">• NiCd och NiMH-batterier med temperatur lägre än +10°C.• Li-ion-batterier med temperatur lägre än +6°C• Djupurladdade eller tomma li-ion-batterier, NiCd och NiMH-batterier.

Underhållsladdning:

- NiCd och NiMH-batterier. Laddström beroende på batteri. Laddningen utförs i serie ca. femton sekunder för varje batteri.
-



Laddteknik

Li-ion-batterier kräver ingen underhållsladdning p.g.a. den låga självurladdningen.

Avstängningsgränser vid snabbladdning:

NiCd och NiMH-batterier:

Timer
Kapacitet
Batteritemperatur
Negativ spänningsdifferens
Temperaturökning per minut
Pulsladdning

Li-ion-batterier:

Timer
Kapacitet
Batteritemperatur
Laddström

Underhållsladdning vid NiCd och NiMH-batterier:

Övervakning av batterispänning, av laddström och batteritemperatur.

Batterityp

- NiCd
 - NiMH
 - Li-ion
-

Laddning- och urladdningstid

Laddning- och urladdningstiderna beror i första hand på maximal laddnings- och urladdningsström, batterikapacitet och batteriets laddning vid laddningsstart.

Följande riktvärden är gällande:

Snabbladdning vid 20°C

NiCd batterier

upp till 2200 mAh 1.0 till 1.5 tim.

upp till 7200 mAh 2.5 till 4.0 tim.

NiMH-batterier

upp till 2200 mAh 1.5 till 2.0 tim.

upp till 4900 mAh 2.0 till 2.5 tim.

upp till 10000 mAh 2.5 till 5.5 tim.

Li-ion-batterier

upp till 4600 mAh 2.5 till 3.5 tim.

Urladdning:

NiCd och NiMH-batterier

6V-batterier med 600 mAh per timme

12V-batterier med 300 mAh per timme

Li-ion-batterier

7.4V-batterier med 500 mAh per timme

Display

Se kapitel "2.6 Signallampor".

Vikt

Laddstation, inkl. två batterieadapter: 1.12 kg

Dimensioner

B X D X H: max. 237 mm x 227 mm x 43 mm; inkl. batteriadapter

Leica GKL221 Laturi Käyttöohje

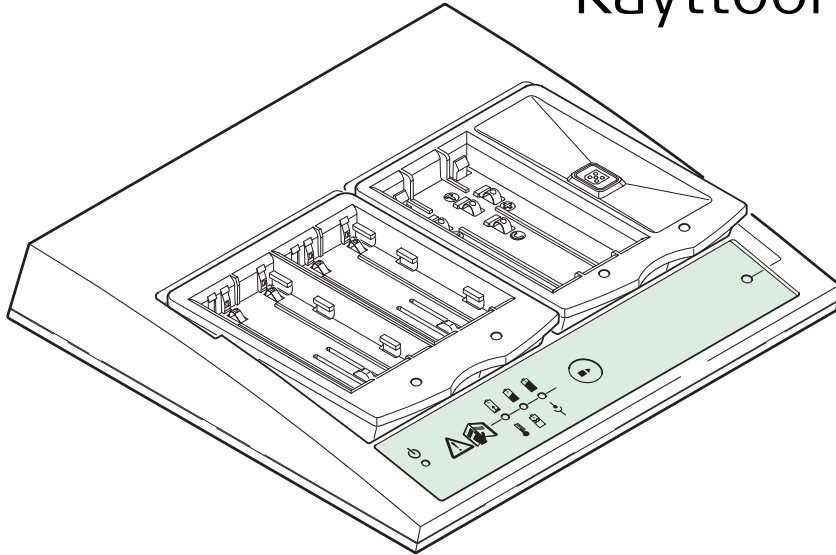

Versio 1.3
Suomi

- when it has to be **right**

Leica
Geosystems

Johdanto



Nämä käyttöohjeet sisältävät käyttöön liittyvien ohjeiden lisäksi myös tärkeitä turvaohjeita. Viittaus osaan "4 Turvaohjeet" lisätietojen saamiseksi.

Lue käyttöohjeet huolellisesti ennen tuotteen käyttämistä.

Tuotetiedot





Malli ja sarjanumero on merkitty tuotteen nimikilpeen. Laita ne käyttöohjeisiin viitteeksi ja anna ne aina kun teet tuotetta koskevia tiedusteluja valtuutetusta Leica Geosystems -korjaamosta.

Malli: _____

Sarjanro.: _____

Käytetyt symbolit

Tässä oppaassa käytetyillä symboleilla on seuraava merkitys:

Symboli	Merkitys
 Vaara	Välitön vaara käytettäessä, mistä seurauksena on henkilöön kohdistuva vakava vamma tai kuolema.
 Varoitus	Vaara käytettäessä tai väärin käytettäessä, mistä voi aiheutua henkilöön kohdistuva vakava vamma tai kuolema.
 Varo	Vaara käytettäessä tai väärin käytettäessä, mistä voi aiheutua vain vähäinen henkilöön kohdistuva vamma, mutta vakava vahinko omaisuudelle, taloudellinen vahinko tai ympäristövahinko.
	Käyttöä koskevat tiedot, jotka auttavat käyttämään tuotetta teknisesti oikein ja tehokkaasti

Sisällysluettelo

Sisällysluettelo	Aihe	Sivu
1	Järjestelmän kuvaus	4
2	Käyttö	8
	2.1 Akkusovite	8
	2.2 Laturin kytkentä	10
	2.3 Akkujen sisäänlaitto ja poistaminen	11
	2.4 Valintapainike	14
	2.5 Akun lataaminen	15
	2.6 Merkkivalot	17
	2.7 Vihjeitä	20
3	Huolto ja kuljetus	21
	3.1 Kuljetus	21
	3.2 Säilytys	21
	3.3 Puhdistus ja kuivaus	21
4	Turvaohjeet	22
	4.1 Yleisohjeita	22
	4.2 Käyttötarkoitus	22
	4.3 Käytön rajoitukset	23
	4.4 Vastuualueet	23
	4.5 Käytön vaarat	24
	4.6 Sähkömagneettinen kelpoisuus	25
	4.7 FCC-lauseke (koskee USA:ta)	26
5	Tekniset tiedot	28

1

Järjestelmän kuvaus

Kuvaus

Leica Geosystems GKL221 on älykäs laturi, jossa on pitkälle kehitetty teknologia. Se on suunniteltu lataamaan kaikki Leican akut. Virtalähteenä voidaan käyttää verkkoa sekä myös GDC221-ajoneuvoliitintä, joka kytketään ajoneuvon savukkeensytyttimen pistorasiaan. GKL221 on hyvin hyödyllinen täydennys kaikkiin akulla toimiviin Leica Geosystems-laitteisiin.

Yleisohjeita

Jopa viisi akkua voidaan kytkeä laturiin. On mahdollista ladata kaksi akkua yhtä aikaa laturin kahdella erillisellä virtapiirillä. Useamman kuin kahden akun ollessa kytkettynä kaikkien muiden lataaminen tapahtuu kytkentäjärjestyksessä.

Lataamisen lisäksi laturi voi myös purkaa ja virkistää akkuja.



Suosittellemme laitteen käynnistämistä tässä kohdassa samalla kun käyttöohjeiden lukemista jatketaan.

Järjestelmän komponentit

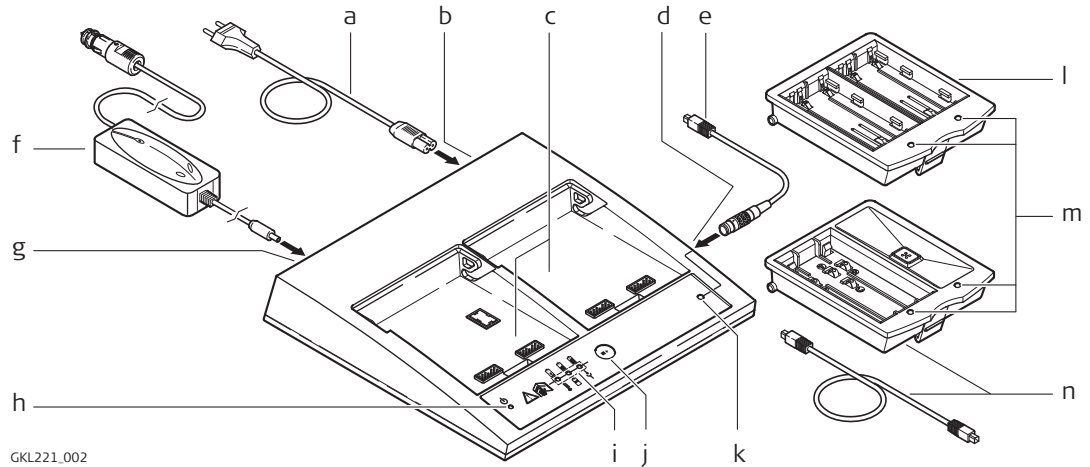

GKL221_002

- a) Maakohtainen verkkojohto
- b) Laturin verkkojohtorasia
- c) Latauspaikat I ja II GDI221- / GDI222-akkusovitteille
- d) Ulkoinen akkukaapeliliitäntä
- e) Kaapelirasia ulkoisille 5-napa-akuille
- f) Ajoneuvoliitin GDC221, lisävaruste
- g) Laturin ajoneuvokaapelirasia
- h) Toimintavalomerkki
- i) Varautumiskyvyn ja virheen valomerkit
- j) Valintapainike
- k) Ulkoisen akkuliitäntätilan valomerkki
- l) GDI221-akkusovite, lisävaruste
- m) Akun tilan merkivalot
- n) GDI222-akkusovitteen ja 5-napainen latauskaapeli, lisävaruste

Uudelleen ladattavat akut

Seuraavat Leica Geosystems-akut voidaan ladata:

GEB90
GEB211
GEB212
GEB221
GEB222
GEB241
GEB242



GEB111
GEB121

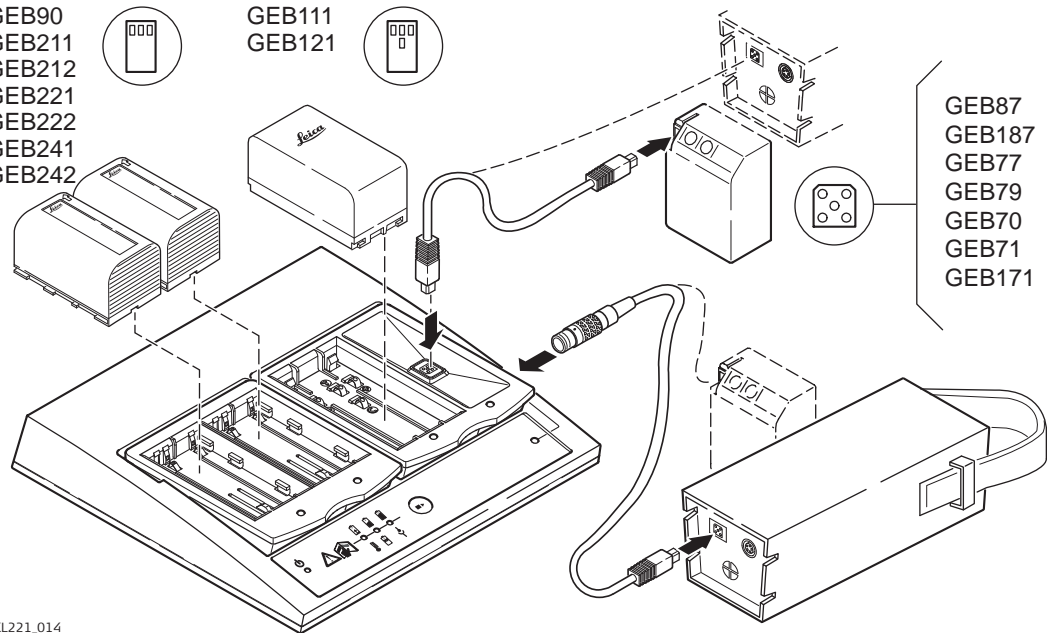

GKL221_014



Laturi on suunniteltu alkuperäisten Leica-akkujen sekä myös joidenkin NiMH/NiCd-videokamera-akkujen uudelleen lataamiseen ja purkamiseen. Viittaus osaan "2.3 Akkujen sisäänlaitto ja poistaminen" lisätietoja varten.

Laturin ja akun sovitteet

Seuraavien akkujen liittäminen laturiin on mahdollista käytettäessä laturia yhdessä akkusovitteiden kanssa:

Laturin/ akun sovite	Uudelleen ladattavat akut
GKL221 kahden GDI221:n kanssa	Enintään neljä Li-ion-akkua ja yksi 5-napaisen pistorasian akku.
GKL221 yhden GDI221:n ja yhden GDI222:n kanssa	Enintään kaksi Li-ion-akkua, yksi videokamera-akku ja kaksi 5-napaisen pistorasian akkua.
GKL221 kahden GDI222:n kanssa	Enintään kaksi videokamera-akkua ja kolme 5-napaisen pistorasian akkua.

2

2.1

Käyttö

Akkusovite

Käyttötarkoitus

Akkusovite liittää laturin vastaaviin akkuihin ja siinä on yksi LED latausaukkoa kohti ja se ilmoittaa akun tilan.

Tyyppi

Seuraavat akkusovitteet ovat saatavissa:

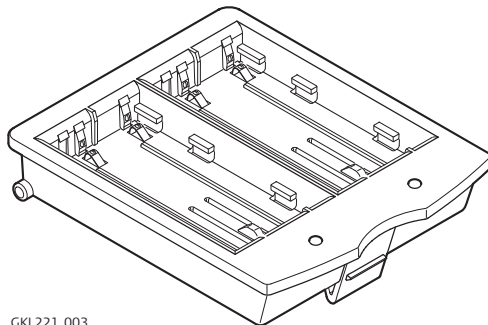

GKL221_003

GDI221

- Kahteen Leica Geosystems Li-ion - akkuun GEB90, GEB211, GEB212, GEB221, GEB222, GEB241 tai GEB242.

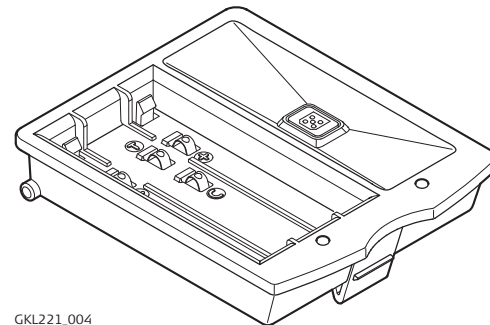

GKL221_004

GDI222

- Yhteen Leica Geosystems NiMH- akkuun GEB111 tai GEB121 ja yhteen NiCd tai NiMH-5-napaiseen akkuun.

Sisäänlaitto ja poistaminen

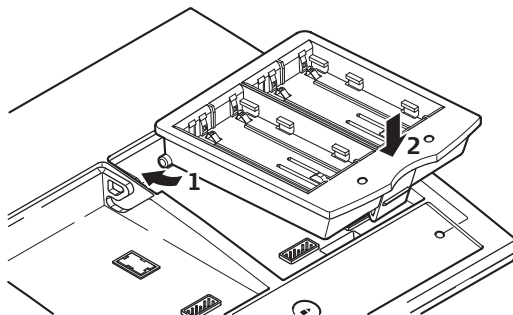

GKL221_005

Sisäänlaitto

1. Laita akkusovite takaosan ohjaussärmää pitkin.
2. Paina akkusovitteen etuosasta, kunnes se napsahtaa ja lukittuu paikalleen.

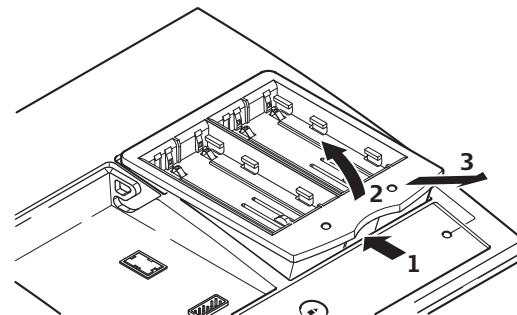

GKL221_006

Poistaminen

1. Avaaminen tapahtuu painamalla akkusovitteen etureunaa.
2. Nosta se ylös varovasti pysähdyskohtaan.
3. Poista sovite vetämällä sitä ulos eteenpäin.

2.2

Laturin kytkentä

Varoitus

Käynnistäminen



Käytä laturia vain kuivissa tiloissa! Älä milloinkaan käytä laturia sen ollessa märkä tai kostea!

Laita laturi aina tukevalle pinnalle ennen sen käynnistämistä.

Kytke laturi joko:

- varustetulla verkkojohdolla sähköpistorasiaan tai
 - lisävarusteena olevalla GDC211 tupakansytytinjohdolla ajoneuvon akkuvirtapiiriin
-

Vedä pistoke sähköpistorasiasta ja ajoneuvon sähkörasiasta, jos laturia ei käytetä pitkään aikaan.

Käytä tupakansytytinjohtoa vain ajoneuvosta tulevaan virransyöttöön. Jos virransyöttö tulee muista lähteistä, kuten muuntajista, häiriöitä saattaa esiintyä. Jännite- ja nimellistehotietojen osalta Viittaus osaan "5 Tekniset tiedot".

Tarkasta vanhemmat ajoneuvot ja varmista, että + napa on savukkeensytyttimen pistorasian kosketuspinnan keskikohdalla. Napaisuuden ollessa väärin laturin sulake tai ajoneuvon liittimen sulake on vaihdettava. Laturin sulakkeen saa vaihtaa vain valtuutettu Leica Geosystems -huoltokorjaamo. Ajoneuvon liittimen sulake on vaihdettava kuten liittimen oppaassa kuvataan.

Sen jälkeen kun liitin on kytketty verkkoon tai ajoneuvon akkuvirtapiiriin, punainen, keltainen ja vihreä toimintavalo syttyvät kerran, varaus- ja virhemerkkivalot palavat punaisena ja vihreänä. Tämä on toimintatarkistus.

Jos akkua ei ole laitettu sisään, silloin vain vihreä toimintavalo syttyy.

Jos tilan merkkivalo ja kolme varaus- ja virhemerkkivaloa syttyvät ja jäävät punaisiksi, virhe on havaittu. Viittaus osaan "2.6 Merkkivalot" lisätietojen saamiseksi.

2.3

Akkujen sisäänlaitto ja poistaminen

Li-Ion-akut

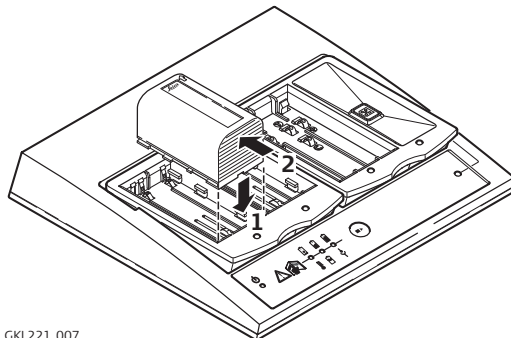

GKL221_007

Sisäänlaitto:

1. Laita akku sisään GDI221-akkuaukon etureunan kanssa samassa tasossa.
2. Työnnä akku hiukan alaspäin painaen pysähdyskohtaan.

Poistaminen:

- Työnnä akkua taaksepäin pysähdyskohtaan ja sen jälkeen poista se.



Lataa tai pura vain Leica Geosystems:n suosittelemia akkuja. Käytä vain Leica Geosystems:n Li-ion-akkuja.

NiCd- ja NiMH-akut

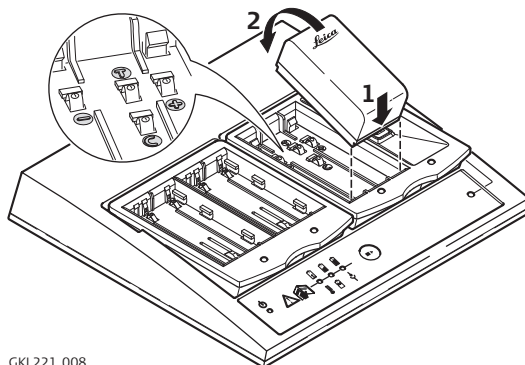

GKL221_008

Sisäänlaitto:

1. Laita akku GDI222-akkuaukon etureunasta sisään.
2. Paina sitä alaspäin, kunnes se napsahtaa paikalleen.

Poistaminen:

- Vedä akun takaosa ylös ja poista se.



Leica Geosystems'in GEB111- ja GEB121-akuissa on neljä kontaktipintaa, kun taas kolmansien osapuolten tekemissä videokamera-akuissa on vain kolme. Laturi osaa tehdä eron näiden kahden akkutyypin välillä ja sovitaa latausprosessin sen mukaisesti.



Kolmen kontaktipinnan videokamera-akujen on täytettävä seuraavat laatuvaatimukset vahingon estämiseksi:

- Jännite: 6 V
- Akkutyypit: NiCd tai NiMH
- Minimiteho: NiCd 1500 mAh, NiMH 1800 mAh
- Yhteensopivat kontaktit oikeassa järjestyksessä, eli "+, T, -" yhdessä rivissä.

Videokamera-akut, jotka täyttävät nämä laatuvaatimukset ovat lämpötilaohjattuja ja ladataan 1,6 A virralla.

5-napaiset latauskosketin-akut

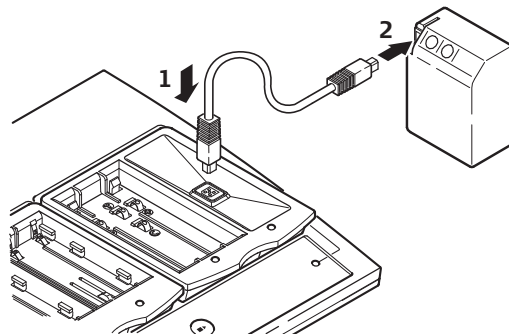

GKL221_009

Leica Geosystems'n 5-napaiset latauskosketin-akut, esim. GEB87 tai GEB70, on kytkettävä 5-napaiseen latauskaapelin latauskoskettimeen.

5-napaiset ulkoiset latauskosketinakut

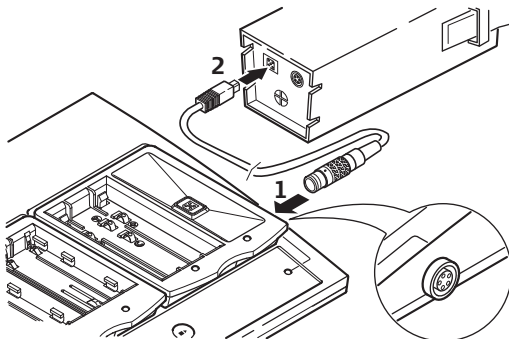

GKL221_010

Leica Geosystems'n 5-napaiset latauskosketin-akut, esim. GEB87 tai GEB70, on kytkettävä latauskaapelin ulkoiseen akkukytkentäkoskettimeen.

☞ Akut, jotka on liitetty ulkoiseen akkukytkentäkoskettimeen, voidaan ladata ilman että alkanut latausprosessi saadetaan loppuun.

FI

2.4

Valintapainike

Toiminnot

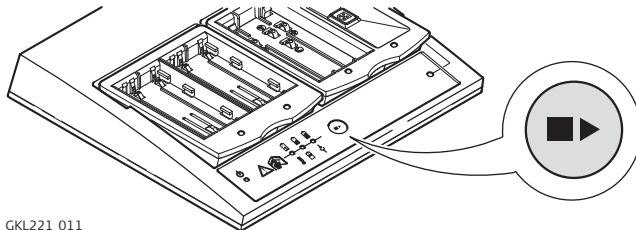

GKL221_011

Valintapainiketta käytetään latausaukon valitsemiseksi ja lataamis- ja purkutilojen väliseen kytkentään.

Toiminnot	Paina valintapainiketta	Kuvaus
Valitse latausaukko	Alle kaksi sekuntia	Seuraava akun sisältävä aukko valitaan. Valittu aukko ilmoitetaan keltaisella tilan merkkivalolla, joka vilkkuu nopeasti noin kolme sekuntia; akun varauskyky myös näytetään.
Lataus- ja purkamistilojen välinen kytkentä	Yli kolme sekuntia	Purkaustilaan kytkemisen seurauksena tilan merkkivalo vilkkuu keltaista-punaista noin viiden sekunnin ajan, lataustilaan kytkemisen seurauksena se vilkkuu kelta-vihreää noin viiden sekunnin ajan.



Purkaminen ilmaistaan punaisella tilan merkkivalon vilkkumisella. Kun purkamisprosessi on suoritettu loppuun, vihreä merkkivalo alkaa vilkkua ilmoittaen, että akkua nyt ladataan.

2.5

Akun lataaminen

Menetelmä

Etene- misvai- heet	Kuvaus
1.	Laita akun liitin sisään.
2.	Kytke laturi virtalähteeseen, vihreä toimintomerkkivalo syttyy.
3.	Laita akku sisään. Keltainen tilan merkkivalo vilkkuu sen merkiksi, että akku on tunnistettu.
4.	Varmistaudu, että vihreä tilan merkkivalo pysyy päällä. Nyt akkua ladataan. Ks. osaa "2.6 Merkkivalot", jos akun kytkemisen jälkeen eri tilan merkkivalo syttyy.  Tarkista tilan merkkivalo noin minuutin kuluttua.
5.	Akku on täysin ladattu, kun vihreä tilan merkkivalo alkaa vilkkua. Ks. osaa "5 Tekniset tiedot" latausaikatietojen saamiseksi.
6.	Akku voidaan poistaa tai jättää kytkentään sen varmistamiseksi, että se on tarvittaessa täysin latautunut. Viittaus osaan "Lataustilat" lisätiedon saamiseksi.

Latausjärjestyksen asetus

GKL221-laturi voi ladata kahta akkua samanaikaisesti.

Kun useampi kuin yksi akku kytketään laturiin, ensiksi kytketty ladataan ensimmäisenä. Kytke aina ensiksi se akku, jota tarvitaan kiireellisemmin.

Tärkeysjärjestys



Akut ladataan ulkoisessa akkuliitännässä keskeyttämättä jo alkanutta latausprosessia.

Täyslatauksen säilyttäminen

Kun akku on täysin latautunut, sen saa jättää kytkentään. NiCd- ja NiMH-akut ladataan vuorotellen niiden täyslatauksen säilyttämiseksi. Näin kompensoidaan sisäinen itsepurkautuminen, ja akku on aina täysin latautunut ja käyttövalmis. Viittaus osaan "Lataustilat" lisätietoja varten.

Akun virkistäminen



Virkistystoiminto purkaa kokonaan akun ja asettaa sen sitten nopeaan lataukseen.

Etene- misvai- heet	Kuvaus
1.	Kytke laturi virtalähteeseen.
2.	Laita akku sisään. Keltainen tilan merkkivalo vilkkuu sen merkiksi, että akku on tunnistettu.
3.	<p>Paina valintapainiketta yli kolme sekuntia akun purkamisprosessin aloittamiseksi. Purkaminen ilmaistaan punaisella tilan merkkivalon vilkkumisella.</p> <p> Suuren varauskyvyn omaavien akkujen purkaminen saattaa kestää kauan. Käytä vain tätä toimintoa tyhjiin tai vähän varautuneisiin akkuihin purkamisaikojen pitämiseksi lyhyinä.</p>
4.	Kun akku on purettu, se asetetaan nopeaan lataukseen. Tilan merkkivalo palaa vihreänä.
5.	Akku on täysin ladattu, kun vihreä tilan merkkivalo alkaa vilkkua.
	Suosittelemme NiCd- ja NiMH-akkujen virkistämistä kahdesta kolmeen kertaan, kun niiden varauskyky alkaa laskea tuntuvasti.
	Yksi purkaus- ja latausjakso riittää Li-ion-akuille. Suosittelemme prosessin suorittamista, kun laturiin tai Leica Geosystems tuotteeseen merkitty akun varauskyky poikkeaa merkittävästi akun käytössä olevasta todellisesta varauskyvystä.



2.6

Merkkivalot





Symbolien selitys



Symboli	Merkitys
	LED pois päältä.
	LED päällä jatkuvasti.
	LED vilkkuu.

Toimintamerkkivalot

Symboli	LED	Merkitys
	Pois päältä	Laturia ei ole kytketty virtalähteeseen.
	Vihreä	Laturi on kytketty virtalähteeseen.

Tilan merkkivalot

Symboli	LED	Merkitys
	Pois päältä	Kytettyä akkua ei ole tunnistettu.
	Keltainen	Kytetty akku tunnistettiin. Laturi on valmiustilassa kahden muun akun ollessa latauksessa tai niitä puretaan.
	Vihreä	Nyt kytkettyä akkua ladataan.
	Vihreä	Kytetty akku on täysin latautunut ja voidaan poistaa.
	Punainen	Laturi on havainnut virheen.





Symboli	LED	Merkitys
	Punainen	Virkistettävä akku on kytketty. Nyt akkua puretaan.
	Keltainen	Ilmoittaa aktiivisen, valitun aukon.

Varauskyvyn ja virheen merkkivalot

- Normaalisessa käytössä kolme varauskyvyn ja virheen merkkivaloa palaa vihreänä valitussa aukossa olevan akun varauskyvyn ilmoittamiseksi. Aukon valitsemisen jälkeen merkkivalot palavat noin kymmenestä viiteentoista sekuntia, minkä jälkeen ne sammuvat.
- Virheen sattuessa varauskyvyn ja virheen merkkivalot vaihtuvat punaiseksi sen merkiksi, että valitussa aukossa on virhe.

Varauskyvyn merkkivalot











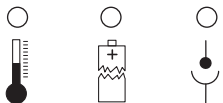



LEDit	Merkitys
	Akun lataus alle 20%.
	Akun lataus on ainakin 20%.
	Akun lataus on ainakin 50%.
	Akun lataus on ainakin 80%.



Tällä hetkellä lataustaso voidaan näyttää vain Leica Geosystems:n GEB211-, GEB212-, GEB221-, GEB222-, GEB241-, GEB242- ja GEB90-akuille.

Virheen merkkivalot



LEDit	Merkitys	Suoritettavat toimenpiteet
  	Akku on liian kylmä tai ylikuumentunut.	Viittaus osaan "Lämpötila-alue" lisätietojen saamiseksi.
  	Akku on viallinen.	Käytä eri akkua.
  	Väärä kontakti akkuun tai akun liittimeen.	Tarkista kontaktit.
  	Laitteistovirhe laturissa.	Ota yhteyttä valtuutettuun Leica Geosystems-huoltokorjaamoon.



Jos laturi ilmoittaa virheen, kun akku on kytketty:

- Kytke eri akku sen selville saamiseksi, onko vika akussa vai laturissa.
- Jos ongelma jatkuu, ota yhteyttä valtuutettuun Leica Geosystems-huoltokorjaamoon.



Virheen sattuessa tarkista myös:

- tuleeko virta verkosta vai ajoneuvon akun virtapiiristä.
- onko kaikki kaapelit kytketty oikein, eikä mitään ilmeisiä vikoja ole havaittavissa.
- palaako toimintavalomerkki lisävarusteeksi kytketyssä ajoneuvoliittimessä.

2.7

Vihjeitä



Vihjeitä

- Akkujen lataaminen niiden täyteen varauskykyynsä vaatii uusien NiCd- ja NiMH-akkujen purkamista kokonaan ja niiden lataamista kolmesta viiteen kertaan.
 - Anna akkujen purkautua laitteessa niin paljon kuin mahdollista. Se estää NiCd-akkujen ns. "muisti-ilmiön".
 - Ajoneuvoliitintä käytettäessä pidä moottori aina käynnissä akkujen latauksen aikana.
-

Vältä äkillisiä ympäristön lämpötilamuutoksia akkujen latauksen aikana (esim. älä anna auringon paistaa suoraan akkuihin tai laturiin). Äkilliset ympäristön lämpötilamuutokset saattavat saada aikaan latausprosessin päättymisen ennenaikaisesti ilman että akut ovat täysin latautuneet.

3

Huolto ja kuljetus

3.1

Kuljetus

Lähetys

Tuotetta rautateitse, ilmaitse tai meritse kuljetettaessa käytä aina täysin alkuperäistä Leica Geosystems -pakkausta, kuljetuslaatikkoa ja pahvikoteloä tai sitä vastaavaa iskulta ja tärinältä suojaamiseksi.

3.2

Säilytys

Tuote

Noudata lämpötilarajoja tuotetta säilytettäessä, varsinkin kesällä, jos tuote on ajoneuvossa. Viittaus osaan "5 Tekniset tiedot" lämpötilarajoja koskevien tietojen osalta.

3.3

Puhdistus ja kuivaus

Tuote

Puhdista tuote aina pehmeällä ja puhtaalla kankaalla.

Kaapelit ja pistokkeet

Pidä pistokkeet puhtaina ja kuivina. Puhalla yhdyskaapelien pistokkeisiin tarttunut lika pois.

4

4.1

Turvaohjeet

Yleisohjeita

Kuvaus

Seuraavien ohjeiden avulla GKL221:n vastuuhenkilö sekä laitteen varsinaiset käyttäjät pystyvät huomiomaan ja välttämään käyttöön liittyvät vaaratekijät

Laitteen vastuuhenkilön tulee varmistaa, että kaikki käyttäjät tuntevat nämä ohjeet ja noudattavat niitä.

4.2

Käyttötarkoitus

Sallitut käyttötavat

- Eriävillä kennoteknologiolla olevien akkujen lataus ja purkaminen.

Kiellettyjä käyttötapoja

- Tuotteen käyttö tuntematta käyttöohjeita
- Tarkoitettujen rajojen ulkopuolinen tuotteen käyttö
- Turvajärjestelmien irtikytkeminen
- Vaarailmoitusten poistaminen
- Laitteen avaaminen käyttäen työkaluja (ruuvimeisseli jne.), ellei tämä ole tiettyjen toimintojen kannalta erityisesti sallittu
- Tuotteen muunnos tai muuttaminen toiseksi
- Anastetun laitteen käyttö
- Ilmeisen tunnistettavissa olevien viallisten tai puutteellisten tuotteiden käyttö
- Muiden valmistajien lisälaitteiden käyttö ilman edeltävää Leica Geosystems:n nimenomaista suositusta



Varoitus

Ohjeiden vastainen käyttö voi johtaa vammaan, toimintahäiriöön sekä aineelliseen vahinkoon. Laitteesta vastaavan henkilön tehtävä on varoittaa käyttäjiä mahdollisista vaaroista ja opastaa heitä välttämään niitä. Tuotetta ei tule käyttää, ennen kuin käyttäjää on kunnolla opastettu käyttämään sitä.

4.3

Käytön rajoitukset

Ympäristö

Sopii käytettäväksi vain kuivassa ympäristössä eikä epäsuotuisissa olosuhteissa.

4.4

Vastuualueet

Valmistaja

Leica Geosystems AG, CH-9435 Heerbrugg, jäljempänä kutsutaan nimellä Leica Geosystems, on vastuussa laitteen toimittamisesta käyttöoppaineen ja alkuperäisine oheislaitteineen käyttöturvallisena ja täydessä toimintakunnossa.

Muut laitevalmistajat

Muut kuin Leica Geosystems'in laitevalmistajat ovat vastuussa laitteidensa käyttöturvallisuuden kehittämisestä, toteuttamisesta ja tiedottamisesta ja vastaavat myös käyttöturvallisuuden tehokkuudesta Leica Geosystems'in laitteissa käytettynä.

Laitteen vastuuhenkilö

Laitteen vastuuhenkilöllä on seuraavat velvollisuudet:

- Ymmärtää laitteen turva- ja käyttöohjeet.
 - Tuntee voimassa olevat paikalliset onnettomuuksien ennaltaehkäisyä koskevat säännöt.
 - Ilmoittaa Leica Geosystemsille välittömästi, jos laitteesta tulee epäluotettava.
-

Varoitus

Laitteen vastuuhenkilön tulee varmistua, että tuotetta käytetään ohjeiden mukaisesti. Hän vastaa käyttökoulutuksen kouluttamisesta ja tuotteen käyttöturvallisuudesta.

4.5

Käytön vaarat

Varoitus

Ohjeiden puuttuminen tai virheelliset ohjeet voivat johtaa väärin tai kiellettyihin käyttömenetelmiin ja aiheuttaa onnettomuuksia. Niistä voi seurata henkilövahinkoja tai aineellista, taloudellista tai ympäristöllistä haittaa.

Varotoimenpiteet:

Kaikkien käyttäjien on noudatettava valmistajan antamia turvaohjeita sekä laitteen käytöstä vastaavan henkilön ohjeita.

Varoitus

Laturi ei ole suunniteltu käytettäväksi kosteissa ja ankarissa olosuhteissa. Jos laite kostuu, se saattaa aiheuttaa sähköiskun.

Varotoimenpiteet:

Käytä laturia vain kuivissa olosuhteissa ja suojaa se kosteudelta. Jos laturi on kostea, älä käytä sitä.

Varoitus

Jos avaat laturin, kumpikin seuraavista toimenpiteistä saattaa aiheuttaa sähköiskun:

- Jännitteellisiin komponentteihin koskeminen.
- Laturin käyttäminen virheellisten korjausten jälkeen.

Varotoimenpiteet:

Älä avaa laturia. Vain Leica Geosystems:n valtuutetut huoltokorjaamot ovat oikeutettuja korjaamaan näitä tuotteita.

Varoitus

Akut, joita Leica Geosystems ei suosittele, saattavat vahingoittaa ladattaessa tai purettaessa. Ne saattavat palaa ja räjähtää.

Varotoimenpiteet:

Lataa ja pura vain Leica Geosystems:n suosittelemia akkuja.

Varoitus

Jos laite hävitetään epäasianmukaisesti, voi tapahtua seuraavaa.

- Jos polymeeriosia poltetaan, syntyy myrkyllisiä kaasuja, jotka saattavat heikentää terveyttä.
- Jos akut vahingoittuvat tai ne kuumenevat voimakkaasti, ne voivat räjähtää ja aiheuttaa myrkytyksen, palamisen, syöpymisen tai ympäristön saastumisen.
- Laitteen vastuuton hävittäminen saattaa mahdollistaa laitteen käyttöön luvattomien henkilöiden rikkomaan ohjeita, altistamaan itsensä ja muut vakavaan vaaraan ja saastuttamaan ympäristöä.

Varoimenpiteet:

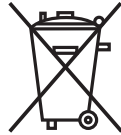

Laitetta ei saa hävittää kotitalousjätteen mukana.

Hävitä laite asianmukaisesti maassasi voimassa olevien säädösten mukaisesti.

Estä aina valtuuttamatonta henkilöstöä pääsemästä käsiksi tuotteeseen.

Tuotekohtaiset käsittely- ja jätehuolto-ohjeet voi ladata Leica Geosystems:n kotisivulta osoitteesta <http://www.leica-geosystems.com/treatment> tai hakea Leica Geosystems -jälleenmyyjältä.

4.6

Sähkömagneettinen kelpoisuus

Kuvaus

"Sähkömagneettisella kelpoisuudella" tarkoitamme, että pystyy toimimaan moitteettomasti olosuhteissa, joissa esiintyy sähkömagneettista säteilyä ja sähköstaattisia varauksia, aiheuttamatta sähkömagneettista häiriötä muille laitteille.

Varoitus

Sähkömagneettinen säteily voi aiheuttaa häiriötä muissa laitteissa.

Vaikka laturi täyttääkin tiukat määräykset ja voimassa olevat laatuvaatimukset, Leica Geosystems ei voi kokonaan pois sulkea mahdollisuutta, että muille laitteille voi aiheutua häiriöitä.



Varo

Saattaa aiheuttaa vian toisissa laitteissa, jos tuotetta käytetään muiden valmistajien komponenttien kanssa, esim. muiden valmistajien kaapelit tai ulkoiset akut.

Varoimenpiteet:

Käytä vain Leica Geosystems:n suosittelemia laitteita tai oheislaitteita. Tuotteen kanssa käytettynä ne täyttävät kaikki tiukat standardit ja vaatimukset.



Varoitus

Tuotteen käyttäminen kaapelien (esim. akkukaapelit) ollessa kytkettyinä pistorasiaan vain toisesta päästä saattaa aiheuttaa elektromagneettisen säteilyrajan ylittymisen ja häiriötä muissa laitteissa.

Varoimenpiteet:

Kun tuotetta käytetään, kaapelien molempien päiden on oltava pistorasiaan kytkettyinä.

4.7

FCC-lauseke (koskee USA:ta)



Varoitus

Tämä laite on tarkastettu ja todettu noudattavan luokan B digitaalisten laitteiden rajoituksia FCC-sääntöjen 15. kohdan mukaisesti.

Nämä rajoitukset on suunniteltu kohtuullisesti suojaamaan haitalliselta häiriöltä asennuksissa asutuilla alueilla.

Tämä laite tuottaa, käyttää ja voi säteillä radiotaajuusenergiaa. Jos sitä ei ole asennettu eikä käytetty ohjeiden mukaisesti, voi tästä aiheutua haitallista häiriötä radioyhteyksiin.

Jos tämä tuote todella aiheuttaa haitallista häiriötä radion kuuluvuuteen tai televisiokuvan vastaanottoon, jonka saa selville katkaisemalla laitteesta virta ja kytkemällä se uudelleen, käyttäjää suositellaan yrittämään poistaa häiriö seuraavilla toimenpiteillä:

- Suuntaa vastaanottoantenni uudelleen tai vaihda sen paikkaa
 - Sijoita laite ja vastaanotin kauemmaksi toisistaan
 - Kytke laite ja vastaanotin eri virran syöttöpiireihin.
 - Kysy neuvoa laitteen myyjältä tai kokeneelta radion/TV:n huoltoteknikolta.
-

Varoitus

Muutokset tai muunnelmat, joita nimenomaisesti Leica Geosystems ei ole yhteensopivuussyistä hyväksynyt, voivat mitätöidä käyttäjän valtuuden käyttää laitetta.

Tarrat

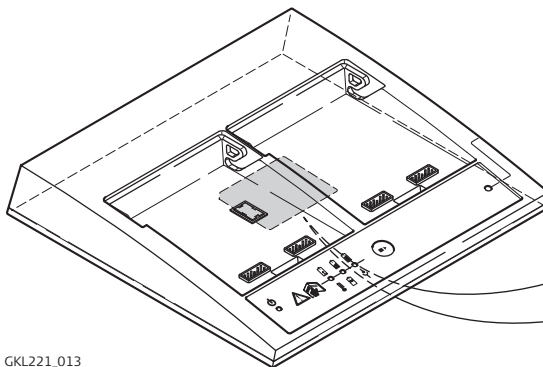

GKL221_013

Type: GKL221

Art.No.:

.....
.....
.....
.....
.....
.....
.....
This device complies with part 15 of the FCC Rules. Operation is subject to the following two conditions: (1) This device may not cause harmful interference, and (2) this device must accept any interference received, including interference that may cause undesired operation.

5

Tekniset tiedot

Virtalähde

- Verkkoliitäntä, ~
- Tasavirtajänniteliitäntä, ==

Tulojännite

- 100 - 240 V, 50/60 Hz
- 24V

Latausvirta

Enintään 18 V / enintään 4,0 A; riippuu akkutyypistä

Purkaminen

4 W

Nimellisteho

~ : 75 W == : 55 W

Käyttöolosuhteet

Käytä vain kuivissa olosuhteissa, esim. rakennuksissa ja ajoneuvoissa
IP40, IEC60529 mukaisesti

Lämpötila-alue

Säilytys:	-40°C - +70°C	-40°F - +158°F
Käyttö:	~ : 0°C - +40°C	+32°F - 104°F
	== : 0°C - +50°C	+32°F - 122°F

Lataustilat

Pikalataus tila:

- Kaikki Leica Geosystems -akut. Se sisältää lämpötilavalvonnan ja akkutunnistuksen. Latausvirta on enintään 4,0 A, akusta riippuen.
- Kaikki vakiovideokamera-akut, joissa on kolme kontaktipintaa ja lämpötilavalvonta. Latausvirta enintään 1,6 A

Normaalilataus tila:

- Alle +10°C lämpötilan NiCd- ja NiMH-akut.
- Alle +6°C lämpötilan Li-ion-akut
- Lähes tai kokonaan tyhjät Li-Ion-, NiCd- ja NiMH-akut.



Latausteknologia

Säilyvä lataustila:

- NiCd- ja NiMH-akut. Latausvirta riippuu akkutyypistä. Lataus tapahtuu vuorotellen noin viisitoista sekuntia akkua kohden.

Li-ion-akut eivät vaadi säilyvää latausta, koska ne eivät menetä varaustaan, kun niitä ei käytetä.

Irtikytkentäolosuhteet pikalataustilassa:

NiCd- ja NiMH-akkuihin:

Ajastin
Varauskyky
Akun lämpötila
Negatiivinen jännite-ero
Lämpötilan nousu minuutissa
Kaksoisvaihtelumenetelmä

Li-ion-akkuihin:

Ajastin
Varauskyky
Akun lämpötila
Latausvirta

NiCd- ja NiMH-akkujen säilyvä lataus :

Valvoo akun jännitettä, latausvirtaa ja akun lämpötilaa.

Kennotyyppi

- NiCd
 - NiMH
 - Li-ion
-

Uudelleenlataus- ja purkamisajat

Uudelleenlataus- ja purkamisajat riippuvat ensi sijassa lataus- ja purkamisvirrasta, akun varauskyvystä ja kytketystä lataustilasta.

Seuraavia ohjeita voidaan antaa:

Pikalataus 20°C:ssa:

NiCd-akut

maks. 2200 mAh 1,0 - 1,5 h

maks. 7200 mAh 2,5 - 4,0 h

NiMH-akut

maks. 2200 mAh 1,5 - 2,0 h

maks. 4900 mAh 2,0 - 2,5 h

maks. 10000 mAh 2,5 - 5,5 h

Li-Ion-akut

maks. 4600 mAh 2,5 - 3,5 h

Purkaminen:

NiCd- ja NiMH-akkuihin

6V akut 600 mAh tunnissa

12V akut 300 mAh tunnissa

Li-Ion-akut

7,4V akut 500 mAh tunnissa

Näyttö

Viittaus osaan "2.6 Merkkivalot".

Paino

Laturi mukaan lukien kaksi akkuliitintä: 1,12 kg

Mitat

L X S X K: enintään 237 mm x 227 mm x 43 mm; mukaan lukien akkuliitin

Leica GKL221 充電器 取扱説明書

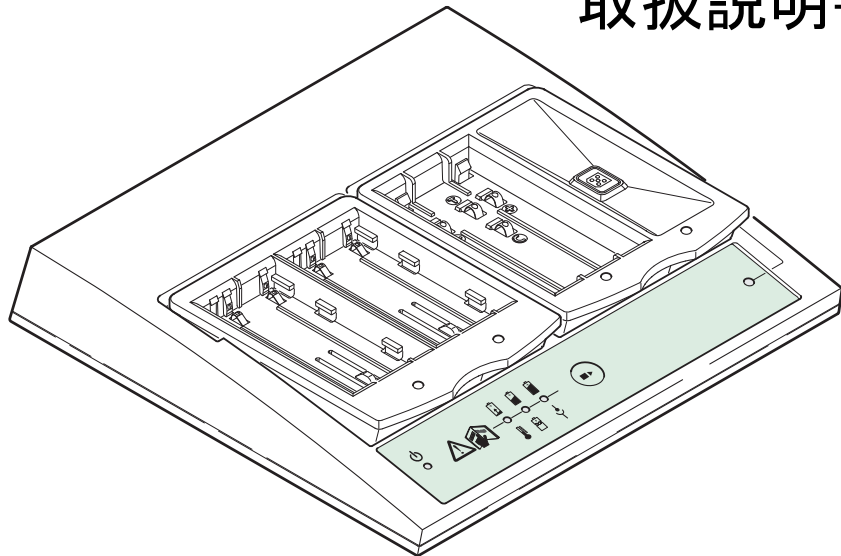

バージョン 1.3
日本語

- when it has to be **right**

Leica
Geosystems

JA

はじめに



この取扱説明書では、器械の設置・操作方法と重要な安全管理について説明されています。詳細については、「4 安全管理」のセクションを参照してください。この取扱説明書をよくお読みいただき、この製品の有効な活用のためにお役立て下さい。

器械の識別

器械の機種名とシリアルナンバーは、製品のネームプレート上に記載されています。取扱説明書に機種名とシリアルナンバーを記入しておき、承認を受けたライカジオシステムズサービス店に製品に関する問い合わせをするときには必ずこの情報をお伝え下さい。

機種名： _____

シリアルナンバー： _____

本取扱説明書で使用されている記号について

この説明書では、以下の記号を使用します。

記号	意味
危険	この記載が遵守されない場合、すぐにも人身事故（死亡または重傷）につながる事項を示します。
警告	この記載が遵守されない場合、人身事故（死亡または重傷）につながる可能性が高い事項を示します。
注意	この記載が遵守されない場合、中程度の人身障害またはかなりの物質的、経済的損失、あるいは環境上の損害を生じる可能性が高い事項を示します。
	器械を、技術的に正しく、かつ有効に使用するために、操作に際して遵守されるべき重要事項を示します。

目次

目次	トピック	ページ
1	システムの説明	4
2	操作説明	8
	2.1 バッテリーアダプター	8
	2.2 充電器の接続	9
	2.3 バッテリーの挿入と取り外し	11
	2.4 選択ボタン	14
	2.5 バッテリーの充電	15
	2.6 インジケーター	17
	2.7 ヒント	20
3	手入れと運搬	21
	3.1 運搬	21
	3.2 保管	21
	3.3 清掃と乾燥	21
4	安全管理	22
	4.1 一般情報	22
	4.2 目的	22
	4.3 使用制限	23
	4.4 責任の範囲	23
	4.5 使用中の危険	24
	4.6 電磁両立性 EMC	25
	4.7 FCC 規定（アメリカ合衆国のみで適用）	26
5	テクニカルデータ	28

一般情報



GKL 221 は高度な充電テクノロジーを採用した最新鋭のバッテリー充電器です。この充電器は、すべてのライカ製バッテリーを充電できるように設計されています。電源として、主電源または自動車のシガレットライターソケットに接続した GDC221 自動車用アダプターを使用できます。GKL 221 は、バッテリーで動作するライカジオシステムズ製品すべてで使用できる非常に便利な製品です。

この充電器には最大 5 本のバッテリーを接続できます。充電器の 2 つの電源回路は独立しており、2 本のバッテリーを同時に充電することができます。3 本以上のバッテリーを接続すると、残りのバッテリーは接続した順に充電されます。

充電以外に、この充電器ではバッテリーの放電およびリフレッシュを行うことができます。

最初はこの取扱説明書を読みながら、この製品を使用されることをお勧めします。

システムのコンポーネント

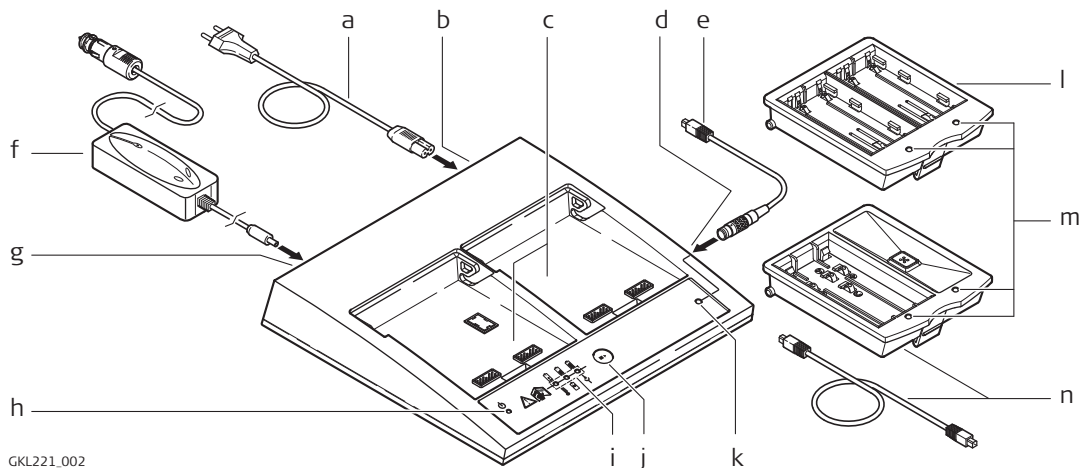

GKL221_002

- a) 主電源ケーブル（国によって異なります）
- b) 充電器の主電源ケーブルソケット
- c) GD1221 / GD1222 バッテリーアダプター用アダプターベイ I および II
- d) 外部バッテリーケーブル接続部
- e) 外部 5 極バッテリー用ケーブルソケット
- f) 自動車用アダプター GDC221（オプション）
- g) 自動車用ケーブルの充電器側ソケット
- h) 機能インジケター
- i) 容量およびエラーインジケター
- j) 選択ボタン
- k) 外部バッテリー接続ステータスインジケター
- l) GD1221 バッテリーアダプター（オプション）
- m) バッテリーステータスインジケター
- n) GD1222 バッテリーアダプターおよび 5 極充電ケーブル（オプション）

JA

リチャージャブルバッテリー

以下のライカジオシステムズバッテリーを充電できます：

GEB90
GEB211
GEB212
GEB221
GEB222
GEB241
GEB242



GEB111
GEB121

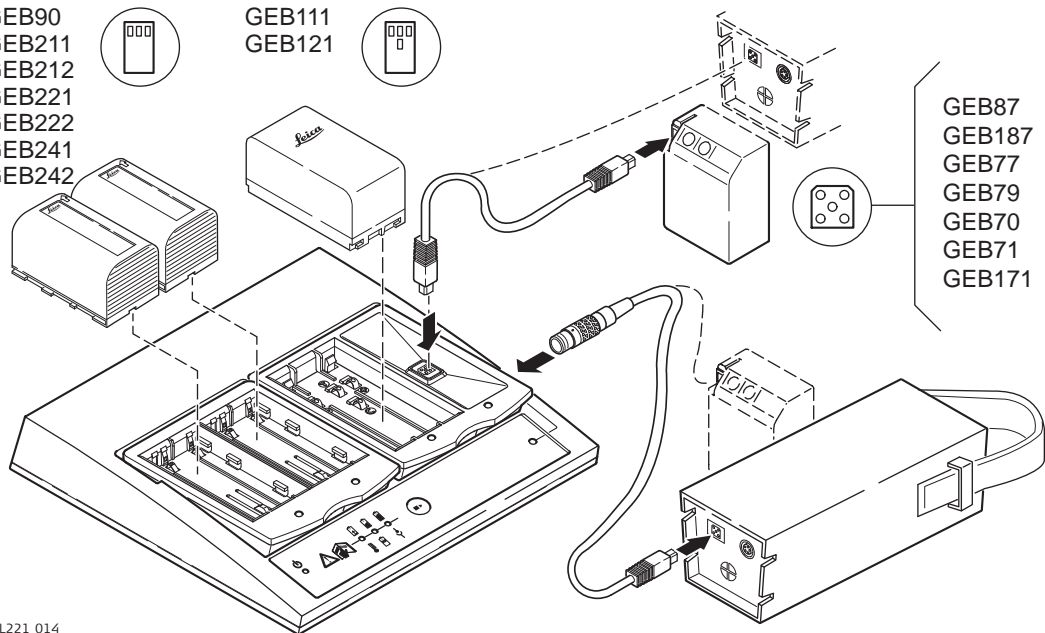

GKL221_014

本充電器は、ライカ製バッテリーおよび数種のニッケル水素 / ニッカドカムコーダーバッテリーの充電および放電用に設計されています。詳細については、「2.3 バッテリーの挿入と取り外し」のセクションを参照してください。



充電器とバッテリーアダプター

充電器をバッテリーアダプターとともに使用することで、以下のバッテリーを充電器に接続することができます：

充電器 / バッテリーアダプター	リチャージャブルバッテリー
GKL221 と 2 個の GDI221	4 本までのリチウムイオンバッテリーと 1 本の 5 極ソケット付きバッテリー
GKL221 と、1 個の GDI221 および 1 個の GDI222	2 本までのリチウムイオンバッテリーと、1 本の カムコーダー型バッテリー、および 2 本の 5 極 ソケット付きバッテリー
GKL221 と 2 個の GDI222	2 本までのカムコーダー型バッテリーと、3 本の 5 極ソケット付きバッテリー

2

操作説明

2.1

バッテリーアダプター

目的

バッテリーアダプターは充電器と対応するバッテリーを接続するもので、充電ペイごとにバッテリーの状態を示すLEDがあります。

タイプ

以下のバッテリーアダプターをご用意しております。

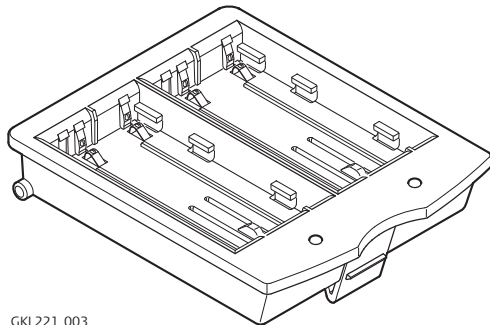

GKL221_003

GD1221

- ・ ライカジオシステムズ リチウムイオンバッテリー GEB90、GEB211、GEB212、GEB221、GEB222、GEB241 または GEB242 2本用

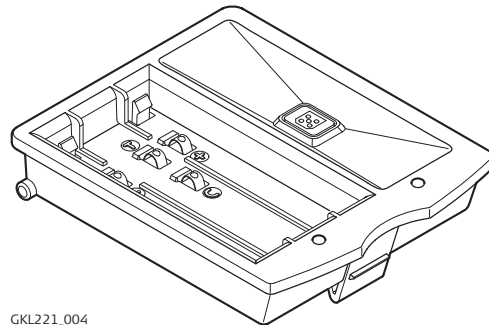

GKL221_004

GD1222

- ・ ライカジオシステムズ ニッケル水素バッテリー GEB111 または GEB121 1本、およびニッカドまたはニッケル水素の5極バッテリー1本用

挿入と取り外し

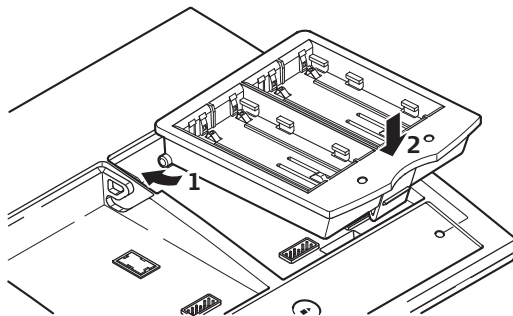

GKL221_005

挿入

1. バッテリーアダプターを後ろ側のガイドエッジに沿って挿入します。
2. バッテリーアダプターの前側を、カチッと音がして固定されるまで押し込みます。

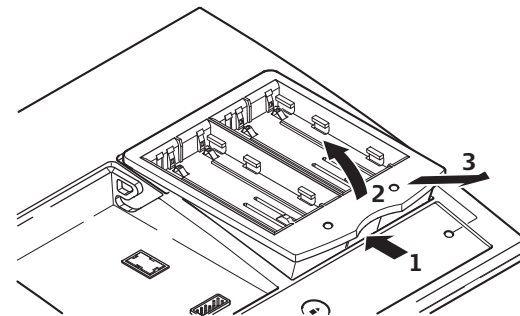

GKL221_006

取り外し

1. バッテリーアダプターの前側を押し開きます。
2. 止まる位置まで注意して持ち上げます。
3. アダプタを前方に引き出して取り外します。

2.2

充電器の接続



警告

充電器は湿気の少ない室内で使用してください！充電器が濡れたり湿ったりしている場合は使用しないでください！

起動

充電器を使用するときには、必ず安定した場所に置いてください。

充電器を以下のいずれかの方法で接続します。

- ・ 付属の主電源ケーブルを主電源ソケットに接続
- ・ オプションの GDC211 自動車用アダプタで自動車のバッテリー回路に接続

JA



充電器を長期間使用しない場合には、メインソケットおよび自動車の電源ソケットからプラグを抜いておきます。



自動車用アダプターは、自動車から電源を供給する場合にのみ使用します。変圧器などの他の供給源から電源を供給すると、故障する場合があります。電圧および定格電力については「5 テクニカルデータ」のセクションを参照してください。



古い自動車の場合には、シガレットライターソケット表面の中央にある接点が+極であることを確認してください。極性が異なっている場合には、充電器のヒューズまたは自動車用アダプターのヒューズを交換する必要があります。充電器のヒューズの交換は、承認を受けたライカジオシステムズサービス店で行います。自動車用アダプターのヒューズは、アダプターのマニュアルの説明に従って交換します。

機能チェック

アダプターを主電源または自動車のバッテリー回路に接続すると、赤、黄および緑の機能インジケーターが1回点灯し、容量およびエラーインジケーターが赤および緑に点灯します。これが機能チェックです。

バッテリーが挿入されていない場合には、緑色の機能インジケーターのみが点灯します。ステータスインジケーターと3個の容量およびエラーインジケーターが赤色に点灯したままになっている場合は、問題が発生しています。詳細については、「2.6 インジケーター」のセクションを参照してください。

2.3

バッテリーの挿入と取り外し

リチウムイオンバッテリー

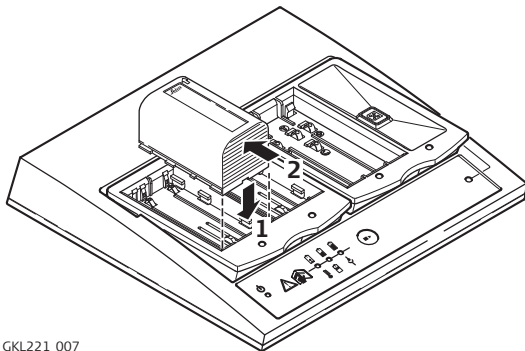

GKL221.007

挿入：

1. バッテリーを、GDI221 バッテリーベイの前面に合わせて挿入します。
2. バッテリーを軽く押しつけ、止まるまで前に押し込みます。

取り外し：

- ・ バッテリーを止まるまで後ろ側に押し、取り外します。



ライカジオシステムズが推奨するバッテリーのみ、充電または放電を行ってください。ライカジオシステムズリチウムイオンバッテリーのみを使用してください。

JA

ニッカドおよびニッケル水素バッテリー

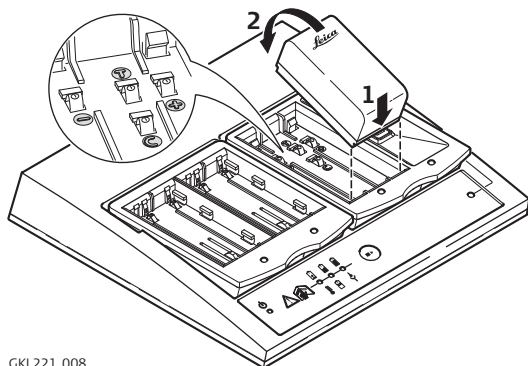

GKL221_008

挿入：

1. バッテリーを、GD1222 バッテリーベイの前端に挿入します。
2. カチッと音がして止まるまで押し込みます。

取り外し：

- ・ バッテリーの後部を引き上げ、取り外します。



サードパーティ製のカムコーダー用バッテリーの接点が3カ所であるのに対して、ライカジオシステムズ GEB111 および GEB121 バッテリーには4カ所に接点があります。本充電器はこの2種類のバッテリーを識別し、それぞれに応じた充電処理を行うことができます。



接点が3カ所のカムコーダーバッテリーは、損傷を防ぐために以下の仕様を満たしている必要があります。

- ・ 電圧：6 V
- ・ バッテリーのタイプ：ニッカドまたはニッケル水素
- ・ 最少容量：ニッカド 1500 mAh、ニッケル水素 1800 mAh
- ・ 電源の並びが互換であること（つまり一列に+、T、-）

これらの仕様を満たすカムコーダーバッテリーは、温度を監視しながら 1.6 A の電流で充電されません。

5極充電ソケット付きバッテリー

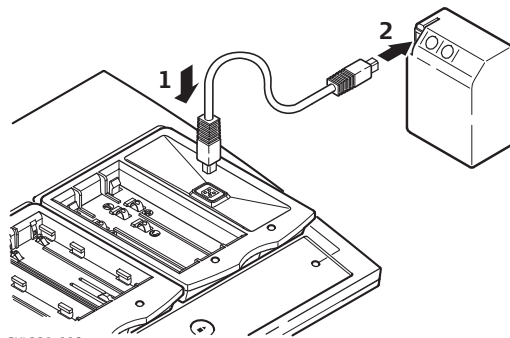

GKL221_009

5極充電ソケット付きのライカジオシステムズバッテリー、たとえば GEB87 または GEB70 は、充電ケーブルの5極充電ソケットに接続しなければなりません。

5極充電ソケット付き外部バッテリー

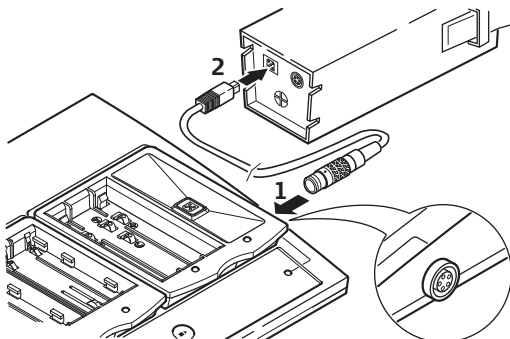

GKL221_010

5極充電ソケット付きのライカジオシステムズバッテリー、たとえば GEB87 または GEB70 は、充電ケーブルの外部バッテリー接続ソケットに接続しなければなりません。

☞ 外部バッテリー接続ソケットのバッテリーの充電は、すでに開始されている充電処理を中断することなく行うことができます。

2.4

選択ボタン

機能

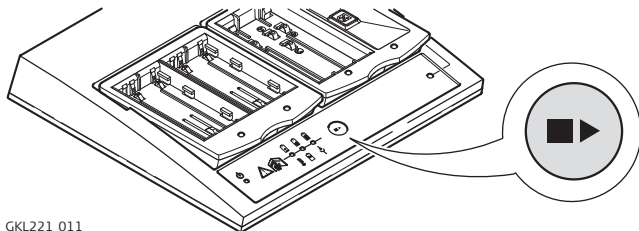

GKL221_011

選択ボタンは、充電ベイを選択して、充電および放電モードを切り替えるのに使用します。

機能	選択ボタンを押す	説明
充電ベイの選択	2 秒未満	バッテリーが取り付けられている次のベイが選択されず。選択されたベイでは 3 秒間黄色のステータスインジケータが点滅し、バッテリーの容量も表示されます。
充電と放電モードの切り替え	3 秒超	放電モードに切り替えるとステータスインジケータが黄 - 赤に 5 秒間点滅し、充電モードに切り替えると黄 - 緑に 5 秒間点滅します。



放電は、赤色のステータスインジケータの点滅で示されます。放電処理が完了したら、緑色のインジケータが点滅しはじめ、バッテリーが充電されていることを示します。

2.5

バッテリーの充電

手順

手順	説明
1.	バッテリーアダプターを挿入します。
2.	充電器を電源に接続します。緑色の機能インジケータが点灯します。
3.	バッテリーを挿入します。黄色のステータスインジケータが点滅し、バッテリーが認識されたことを示します。
4.	緑色のステータスインジケータが点灯しているのを確認してください。 点灯していればバッテリーは充電中です。バッテリーの接続後に別のステータスインジケータが点灯した場合には、「2.6 インジケータ」のセクションを参照してください。  1分後にステータスインジケータを確認します。
5.	バッテリーが完全に充電されると、緑色のステータスインジケータが点滅し始めます。充電時間については、「5 テクニカルデータ」のセクションを参照してください。
6.	バッテリーは取り外しておくか、必要なときに常に完全に充電されているようにするためにそのまま接続しておくことができます。詳細については、「充電モード」のセクションを参照してください。

充電シーケンスの設定

GKL221 充電器では、2本のバッテリーを同時に充電することができます。複数のバッテリーを充電器に接続すると、最初に接続したバッテリーから充電されます。必ず緊急に充電が必要なバッテリーから接続するようにします。

充電の優先



外部バッテリーソケットに接続したバッテリーは、すでに開始された充電処理を中断することなく充電することができます。

満充電状態の維持

バッテリーが完全に充電された後も、接続したままにしておくことができます。ニッカドおよびニッケル水素バッテリーは、満充電状態を維持するために順に充電されます。この方法によって自己放電現象による放電を補い、バッテリーを常に満充電状態に保っていつでも使用できるようにすることができます。詳細については、「充電モード」のセクションを参照してください。

バッテリーのリフレッシュ



リフレッシュ機能では、バッテリーを完全に放電してから急速充電を行います。

手順	説明
1.	充電器を電源に接続します。
2.	バッテリーを挿入します。黄色のステータスインジケータが点滅し、バッテリーが認識されたことを示します。
3.	選択ボタンを3秒以上押して、バッテリーの放電処理を開始します。放電は、赤色のステータスインジケータの点滅で示されます。  大容量バッテリーの場合、放電に長時間かかる場合があります。放電を短時間で終了するために、この機能はバッテリーの充電量がゼロか少ない場合のみ利用します。
4.	バッテリーが放電されると、急速充電が行われます。ステータスインジケータは緑色に点灯します。
5.	バッテリーが完全に充電されると、緑色のステータスインジケータが点滅し始めます。
	ニッカドおよびニッケル水素バッテリーの容量が著しく少なくなってきた時には、2～3回リフレッシュ処理を行うことをお勧めします。
	リチウムイオンバッテリーの場合、1回の放電と充電で十分です。充電器やライカジオシステムズ製品が示す容量が、バッテリーの実際に使用できるはずの容量よりも大幅に少なくなってきたときには、この処理を行うことをお勧めします。



2.6

インジケータ





記号の説明



記号	意味
	LED 消灯
	LED 点灯
	LED 点滅

動作インジケータ

記号	LED	意味
	消灯	充電器が電源に接続されていません。
	緑色	充電器が電源に接続されています。

ステータスインジケータ

記号	LED	意味
	消灯	接続されたバッテリーが認識されていません。
	黄色	接続されたバッテリーが認識されました。充電器は、他の2本のバッテリーが充電または放電中なので、スタンバイモードになっています。
	緑色	接続されたバッテリーを充電しています。
	緑色	接続されたバッテリーが完全に充電され、取り外すことができます。





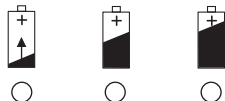

記号	LED	意味
	赤色	充電器でエラーを検知しました。
	赤色	リフレッシュするバッテリーが接続されています。バッテリーは放電中です。
	黄色	選択されたアクティブなペイを示しています。

容量およびエラーインジケータ

- ・ 通常の操作では、3個の容量およびエラーインジケータは緑色に点灯し、選択したペイのバッテリーの容量を示します。ペイを選択すると、インジケータは10～15秒間点灯した後に消灯します。
- ・ エラーがあった場合には、容量およびエラーインジケータは赤色になり、選択したペイにエラーがあることを示します。

容量インジケータ









LED	意味
○ ○ ○	バッテリーの充電量が20%未満です。
 ○ ○	バッテリーの充電量は20～50%です。
  ○	バッテリーの充電量は50～80%です。
  	バッテリーの充電量は80%以上です。

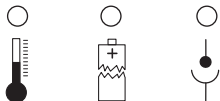

現在、充電量のレベルはライカジオシステムズ GEB211, GEB212, GEB221, GEB222, GEB241, GEB242 および GEB90 バッテリーの場合にのみ表示されます。

エラーインジケータ



LED	意味	行うべき措置
 ○ ○	バッテリーが冷えすぎているか過熱しています。	詳細については、「温度制限」のセクションを参照を参照してください。
○  ○	バッテリーが故障しています。	別のバッテリーを使用してください。
○ ○ 	バッテリーまたはバッテリーアダプターの接点に問題があります。	接点の点検を行います。
  	充電器のハードウェアエラーです。	承認を受けたライカジオシステムズサービス店にご連絡ください。



バッテリーを接続したときに充電器がエラーを示した場合には：

- ・ 別のバッテリーを接続して、問題がバッテリーにあるのか充電器にあるのかをチェックする。
- ・ 問題が解決しない場合には、承認を受けたライカジオシステムズサービス店にご連絡ください。



エラーが発生したときには、以下の事項についてもチェックしてください。

- ・ 主電源または自動車のバッテリー回路から電源が供給されているか。
- ・ ケーブルがすべて正しく接続され、明らかな問題がないか。
- ・ オプションで接続する自動車用アダプターの機能インジケータが点灯していないか。

2.7

ヒント

ヒント

- ・ バッテリーを容量一杯まで充電するには、新しいニッカドおよびニッケル水素バッテリーの場合は、完全に放電してから充電する処理を3～5回行う必要があります。
- ・ バッテリーはできるだけ器械内で消費させます。これによりニッカドバッテリーの「メモリー効果」を防ぐことになります。
- ・ 自動車用アダプターを使用するときは、バッテリーの充電中は必ずエンジンをかけたままにしてください。



バッテリー充電中に、周辺の温度が急激に変化しないようにしてください（たとえば、バッテリーや充電器に直射日光を当てないようにしてください）。周辺の温度が急激に変化すると、充電処理が早く終了して、バッテリーが完全に充電できない場合があります。

3 手入れと運搬

3.1 運搬

輸送 この製品を鉄道、飛行機または船舶で輸送するときは、必ずライカジオシステムズが出荷時に使用した梱包材、輸送用コンテナおよび外箱を使用するか、同等の梱包を行い、衝撃や振動から保護してください。

3.2 保管

製品 器械を保管する場合、特に夏期に社内で保管する場合は、保管中の温度に注意してください。温度制限については、「5 テクニカルデータ」のセクションを参照してください。

3.3 清掃と乾燥

製品 器械を清掃するときは、柔らかくて清潔な布を使用してください。

ケーブルとプラグ ケーブルおよびプラグは清潔かつ乾いた状態に保ってください。接続ケーブルのプラグにたまったほこりは吹き飛ばしてください。

4

安全管理

4.1

一般情報

説明

以下の指示は、GKL221 の取扱責任者、および製品を実際に使用するすべての人が、操作上の危険を予想し、回避するためのものです。

操作を行う全ての人に、危険性とその危険への対応を指導することは、取扱責任者の仕事です。

4.2

目的

許可されている用途

- ・ 異なるセル技術のバッテリーの充電および放電

禁止事項

- ・ 事前に指導を受けていない人による使用
- ・ 意図した使用制限を越えた製品の使用
- ・ 安全システムを解除した状態での使用
- ・ 注意書きを取外した状態での使用
- ・ 一定の機能について特別な許可を受けた場合以外に、道具（ドライバーなど）を使って器械を分解すること
- ・ 製品の改造または変造
- ・ 盗難された器械であることを承知しての使用
- ・ 明らかに損傷しているか故障している製品の使用
- ・ ライカジオシステムズ（株）から明確な承認を得ずに他社製のアクセサリを使って器械を使用すること



警告

禁止事項を遵守せずに使用した場合、人身事故、故障あるいは破損の原因につながります。操作を行う全ての人に、危険性とその危険を避ける方法を指導することは、取扱責任者の責務です。この製品の使用方法の説明を事前に受けてから使用してください。

4.3

使用制限

環境

湿気のない環境での使用にのみ適し、過酷な環境には適しません。

4.4

責任の範囲

製造者

Leica Geosystems AG, CH-9435 Heerbrugg (以下ライカジオシステムズとします) は、完全に安全な条件下での製品、取扱説明書、およびオリジナルのアクセサリーの供給に責任を負います。

サードパーティの製造者

ライカジオシステムズ以外のアクセサリの製造者は、その製品に関する安全対策を構築し、導入し、説明する責任があります。また、アクセサリーの製造者は、ライカジオシステムズの器械と組み合わせて使用する上での安全対策についても責任があります。

製品の取扱責任者

本製品の取扱責任者には以下のような責任があります。

- ・ 器械の安全対策と取扱説明書の内容を理解すること。
- ・ 使用する場所での安全と事故予防に関する規定に精通していること。
- ・ 製品の安全が損なわれたと判断した場合は、すぐにライカジオシステムズへ連絡すること。

警告

製品の取扱責任者は取扱説明書に基づいて安全に器械が使用されるようにしなければなりません。また、取扱責任者は器械を使用する全ての人のトレーニング、能力開発、および使用時の安全管理について責任を負います。

4.5

使用中の危険



警告

説明に従わなかったり、説明の理解が不十分である場合には、誤った方法で使用したり禁止事項を実行してしまうことになります。その結果、人身事故、物損事故または、経済上および環境上の問題を引き起こす恐れがあります。

予防措置：

器械を使用する全ての人は、製造者が指示した安全対策と、器械の取扱責任者の指示に従わなければなりません。



警告

充電器は湿った場所や過酷な環境では使用できません。湿った状態で充電器を使用すると、感電する恐れがあります。

予防措置：

充電器は乾燥した環境でのみ使用してください。充電器が湿らないようにしてください。湿った充電器は使用しないでください。



警告

充電器を分解すると、次のいずれかが原因で感電することがあります。

- ・ 電圧がかかっている部分に触れる。
- ・ 不正な修理を行った後に充電器を使用する。

予防措置：

充電器は決して分解しないでください。修理を行えるのはライカジオシステムズが認定したサービス店のみに限られます。



警告

ライカジオシステムズが推奨しないバッテリーを充電または放電すると、故障することがあります。燃焼または爆発のおそれがあります。

予防措置：

ライカジオシステムズが推奨するバッテリーのみ、充電および放電を行ってください。

警告

器械を不当に処分すると、以下のような事態が生じる危険があります。

- ・ ポリマー部分を焼却すると有毒ガスが発生し健康を害する恐れがあります。
- ・ バッテリーが破損したり強く熱せられると、爆発、毒物の発生、火事、腐食、あるいは環境汚染の原因になります。
- ・ 器械を無責任に廃棄処分すると、使用する資格のない人物が規定を守らずに使用し、本人あるいは第三者が重傷を負う危険にさらされたり、環境汚染を引き起こす恐れがあります。

予防措置：



絶対に家庭ごみと一緒に製品を廃棄しないでください。
製品の処分は、各国の国内基準により適切に行ってください。
資格のない人が、製品に触れないようにしてください。

本製品特有の扱い方および廃棄管理に関する情報は、ライカジオシステムズのホームページ (<http://www.leica-geosystems.com/treatment>) からダウンロードするか、ライカジオシステムズの代理店から入手できます。

4.6

電磁両立性 EMC

説明

「電磁障害の許容値」という語は、電磁界および静電気の放電がある環境で、この製品が支障なく機能し、また他の器械を妨害しない能力を意味します。

警告

電磁気の放出が他の機器を妨害する可能性があります。

バッテリー充電器は厳しい規定と規格に適合していますが、ライカジオシステムズは他の機器を妨害する可能性を完全に否定できません。



注意

製品をサードパーティの部品（たとえばサードパーティのケーブルや外部バッテリー）とともに使用した場合、他の器械に障害を与えることがあります。

予防措置：

ライカジオシステムズが推奨する器械またはアクセサリのみを使用してください。厳密な基準および要件を満たす製品とともに使用してください。



警告

器械にケーブル（たとえばバッテリーケーブル）の一方のみを接続して使用すると、許容される水準を超える電磁気が放出され、他の機器を妨害することがあります。

予防措置：

器械を使用する際は、ケーブルの両端を接続してください。

4.7

FCC 規定（アメリカ合衆国のみで適用）



警告

FCC 規定の第 15 条に則ってテストを行った結果、この製品は、クラス B のデジタル装置の制限内であることが確認されました。

このことは住居内に設置して通常の状態で使用する場合、他の機器を妨害するレベルおよび他の機器から妨害を受けないレベルが、問題ないレベルであることを示しています。

この製品は、周波エネルギーを発生し、使用し、また放射します。不正な設置や使用においては、無線通信の障害の原因になり得ます。

この製品の電源のオン / オフにより、この製品がラジオやテレビの受信に妨害を与えていることが確認された場合は、以下の方法の 1 つまたはいくつかを実行して妨害を回避してください。

- ・ 受信アンテナの方向、または場所を変える。
 - ・ 器械と受信機の間隔を開ける。
 - ・ 受信機を接続している回路とは別のコンセントに器械を接続する。
 - ・ ラジオ / テレビの販売店や技術者に相談する。
-



警告

ライカジオシステムズの明確な承認なしに製品を変更、または修理した場合は、この製品を操作する権利を放棄したものとみなします。

ラベル

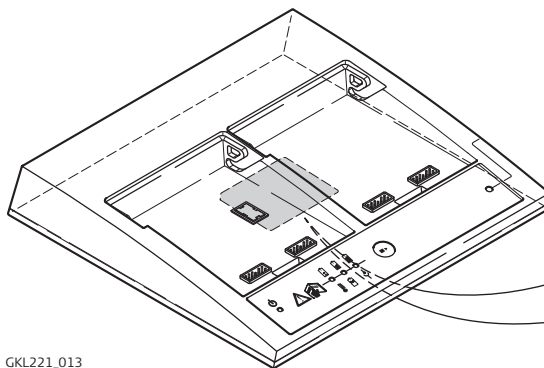

GKL221_013

Type: GKL221

Art.No.:

.....
.....
.....
.....
.....
.....
.....
.....
.....
.....
This device complies with part 15 of the FCC Rules. Operation is subject to the following two conditions: (1) This device may not cause harmful interference, and (2) this device must accept any interference received, including interference that may cause undesired operation.

5

テクニカルデータ

電源	<ul style="list-style-type: none">・ 主電源 ~・ 直流電源==
入力電圧	<ul style="list-style-type: none">・ 100 - 240 VAC、50/60 Hz・ 24VDC
充電電源	最大 18 VDC / 最大 4.0 A、バッテリーのタイプに依存
放電	4 W
定格消費電力	~ : 75 W == : 55 W
動作環境	建物内や自動車内など、乾燥した環境でのみ使用 IP40 (IEC60529 準拠)
温度制限	保管 : -40° ~ +70° C 操作 : ~ : 0° ~ +40° C == : 0° ~ +50° C
充電モード	急速充電モード : <ul style="list-style-type: none">・ すべてのライカジオシステムズバッテリーで利用可。温度モニターとバッテリー認識機能あり。充電電流は最大 4.0 A で、バッテリーの種類に依存。・ 3 個の接点と温度モニター機能を持つすべての標準カムコーダーバッテリー。充電電流は最大 1.6 A。 通常充電モード : <ul style="list-style-type: none">・ 温度 +10° C 未満のニッカドおよびニッケル水素バッテリー。・ 温度 +6° C 未満のリチウムイオンバッテリー。・ ほとんど、または完全に放電したリチウムイオン、ニッカドおよびニッケル水素バッテリー。

保持充電モード：

- ・ ニッカドおよびニッケル水素バッテリー。充電電流はバッテリーのタイプに依存。15 秒ごとに各バッテリーを交互に充電。



充電技術

リチウムイオンバッテリーは、使用していないときには充電量は減少しないので保持充電は不要。

急速充電モードがオフになる条件：

ニッカドおよびニッケル水素バッテリーの場合：

タイマー
容量
バッテリー温度、
負電圧差
1分あたりの温度上昇
二重屈曲法

リチウムイオンバッテリーの場合：

タイマー
容量
バッテリー温度、
充電電流

ニッカドおよびニッケル水素バッテリーの保持充電：

バッテリー電圧、充電電流およびバッテリー温度をモニター

セルのタイプ

- ・ ニッカド
- ・ ニッケル水素
- ・ リチウムイオン

再充電と 放電時間

再充電と放電時間は、主に充電および放電電流、接続されたときのバッテリーの容量と充電状態に依存します。

以下の指標を参考にしてください。

20° Cでの急速充電：

ニッカドバッテリー	ニッケル水素バッテリー	リチウムイオンバッテリー
最大 2200 mAh 1.0 ~ 1.5 時間	最大 2200 mAh 1.5 ~ 2.0 時間	最大 4600 mAh 2.5 ~ 3.5 時間
最大 7200 mAh 2.5 ~ 4.0 時間	最大 4900 mAh 2.0 ~ 2.5 時間	
	最大 10000 mAh 2.5 ~ 5.5 時間	

放電：

ニッカドおよびニッケル水素バッテリーの場合：	リチウムイオンバッテリー
6V バッテリー 1 時間あたり 600 mAh	7.4V バッテリー 1 時間あたり 500 mAh
12V バッテリー 1 時間あたり 300 mAh	

インジケーター

「2.6 インジケーター」のセクションを参照

重量

1.12 kg (バッテリーアダプター 2 個を含む)

寸法

W X D X H: 最大 237 mm x 227 mm x 43 mm (バッテリーアダプターを含む)

Leica GKL221 充电器 用户手册

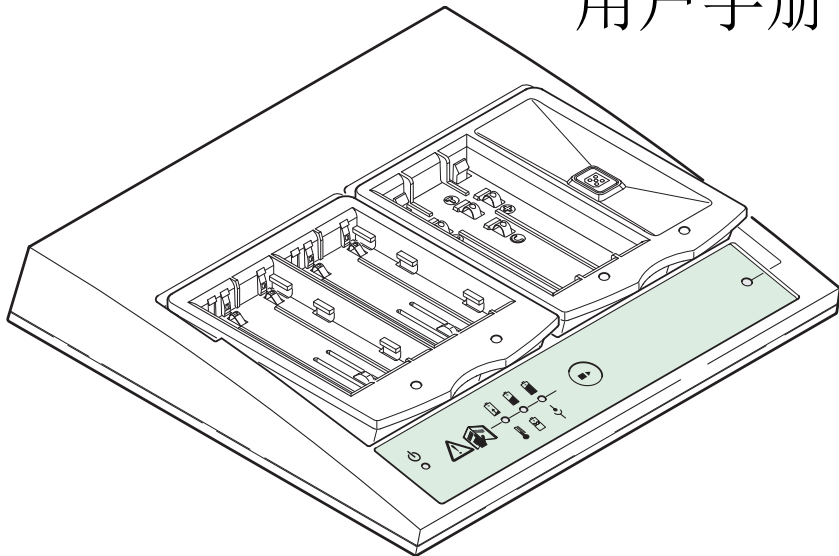

1.3 版
中文

- when it has to be **right**

Leica
Geosystems

ZH

简介



本手册包括了重要的安全指南，可指导您安全地安置并使用仪器。参考“4 安全指南”获取进一步信息。在开机之前请仔细阅读此手册。

仪器标识





仪器的型号和序列号标在仪器型号铭牌上。请将仪器型号和序列号填写在下本手册中。当您需要与经销商。

类型： _____

序列号： _____

符号

本手册中所使用的符号有如下的含义：

类型	说明
 危险	指出一个即将来临的危险情形，如果不加以避免，将导致死机或严重损害。
 警告	指出一个潜在的危险情形或一项不留意的使用，如果不加以避免，将导致死机或严重损害。
 注意	指出一个潜在的危险情形或一项不留意的使用，如果不加以避免，将导致较小或适度的损害 及 / 或 可感知的材料、经济和环境的损失。
	表示在实际使用中必须注意的重要章节，以便能够正确、有效地使用该仪器。

目录

在本手册中

章节	页
1 系统描述	4
2 操作	8
2.1 电池适配器	8
2.2 连接充电器	10
2.3 插入和拔出电池	11
2.4 选择按钮	14
2.5 电池充电	15
2.6 指示灯	17
2.7 提示	20
3 保养与运输	21
3.1 运输	21
3.2 存储	21
3.3 清洁与干燥	21
4 安全指南	22
4.1 概述	22
4.2 目的	22
4.3 使用限制	22
4.4 责任范围	23
4.5 使用中存在的危险	23
4.6 电磁兼容性 EMC	25
4.7 FCC 声明, 适用于美国	26
5 技术参数	28

1

系统描述

说明

徠卡测量系统的 GKL221 智能充电器融合了先进的充电技术。可为徠卡所有类型的电池充电。电源供电，可以使用电源线或连接到汽车点烟器端口的 GDC221 车载适配器。GKL221 是您徠卡测量产品所有电池的有效补充。

一般信息

最多可连接 5 块电池。最多可同时充两块电池。当连接了两块以上的电池时，其余的将按连接顺序充电。

除充电外，充电器还可用于再生。



建议您在此时可以打开产品，然后再继续阅读操作指南。

系统组成

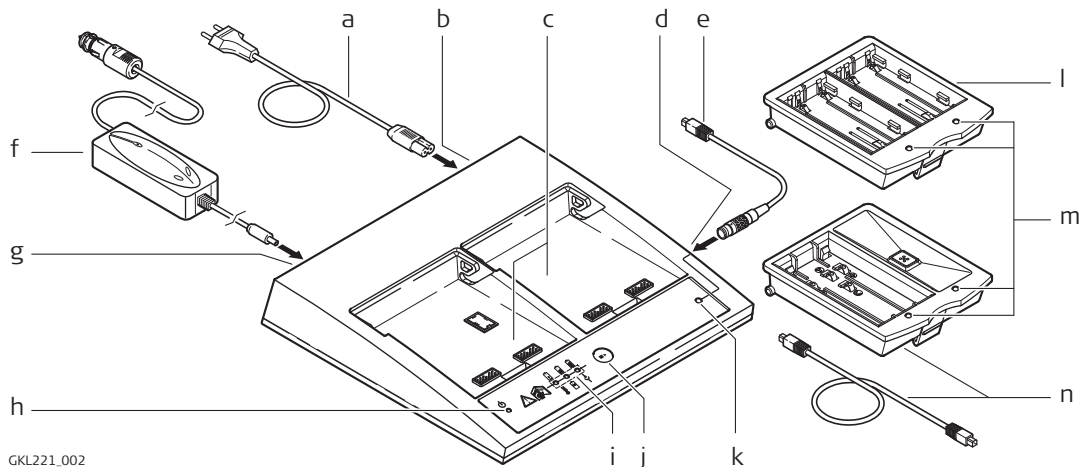

GKL221_002

- a) 电源线，各国家不同
- b) 电源线插孔（位于充电器上）
- c) 适配槽 I 和 II，针对电池适配器 GDI221/GDI222
- d) 外接电池电缆连接
- e) 电缆插头，可充外接 5 针电池
- f) 车载适配器 GDC221，可选
- g) 车载电缆插孔（位于充电器上）
- h) 功能指示灯
- i) 容量和错误指示灯
- j) 选择按钮
- k) 外接电池连接状态指示灯
- l) GDI221 电池适配器，可选
- m) 电池状态指示灯
- n) GDI222 电池适配器和 5 针充电电缆，可选

可充电电池

可充以下 Leica Geosystems 的电池

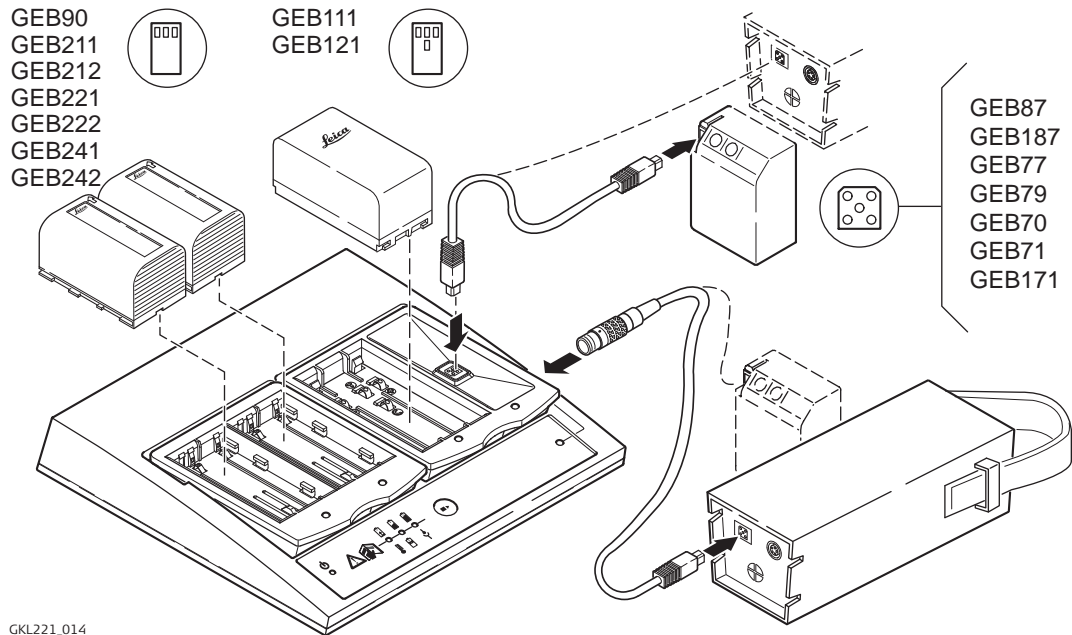

GKL221_014

本充电器可用于徕卡原装电池和某些 NiMH/NiCd 电池的充放。参考章节“2.3 插入和拔出电池”获取更多信息。



充电器和电池适配器

将充电器和不同电池适配器配合使用，可以为以下电池充电：

充电器 / 电池适配器	可充电电池
GKL221 带两个 GDI221	最多可充 4 块锂电池和一块 5 针端口电池。
GKL221 带一个 GDI221 和一个 GDI222	最多两锂电池，一块镍氢电池和两块 5 针端口电池。
GKL221 带两个 GDI222	最多 2 块镍氢电池和 3 块 5 针端口电池。

2

2.1

目的

类型

操作

电池适配器

电池适配器的作用是连接充电器和对应的电池，每个充电槽都有一个 LED 灯，显示电池状态。

有以下这些电池适配器：

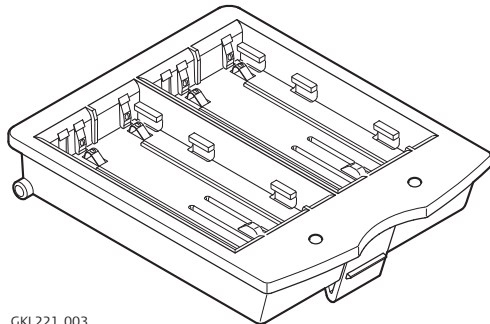

GKL221_003

GDI221

- 针对两块 Leica Geosystems GEB90, GEB211, GEB212, GEB221, GEB222, GEB241 或 GEB242 锂电池。

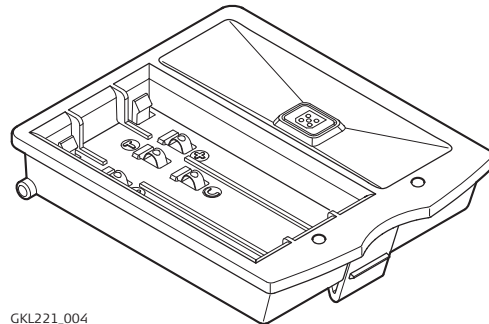

GKL221_004

GDI222

- 针对 Leica Geosystems GEB111 或 GEB121 镍氢电池和一块 5 针端口镍氢或镍镉电池。

插入和拔出

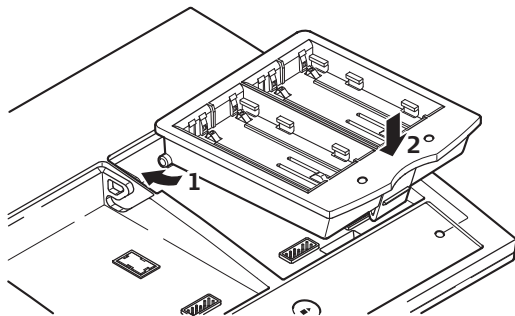

GKL221_005

插入

1. 沿着后方导杆边插入电池适配器。
2. 按住电池适配器的正面，直到卡住并锁定在位置上。

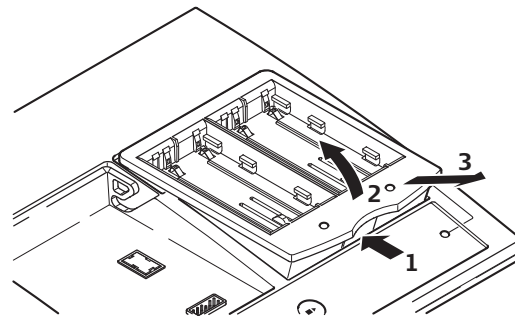

GKL221_006

拔出

1. 按住电池适配器的前方边缘打开。
2. 小心地拎高直到停平点。
3. 向前拉出来拔出适配器。

2.2

连接充电器



警告

开始

请在干燥的室内使用充电器！ 请不要在充电器潮湿的时候使用！

在充电前将充电器置于坚硬的表面！

充电器连接：

- 使用提供的电源电缆，连接到电源插孔或
 - 使用可选的 GDC211 车载适配器，连接到车载电池组。
-



如果要长时间不用充电器，从电源插座或车辆的电源插座拔掉电源插头。



仅使用车载适配器利用汽车电源供电。如果使用其它来源供电，如转换器等，可能发生故障。请参考“5 技术参数”获取更多关于电压和额定功率的信息。



请检查旧的汽车，确认正极在点烟器插头接触面的中央。如果极性不正确，那么必须更改充电器或车载适配器的保险丝。充电器保险丝的更改必须由 Leica Geosystems 维修部门授权。车载适配器保险丝必须按照适配器指南中的描述来更改。

功能检查

在适配器连接到电源或车载电池组后，红色，黄色，绿色功能指示灯将亮一次，容量和故障指示灯呈红色和绿色。这就是功能检查。

如果未插入电池，那么仅有绿色功能指示灯将会亮起。

如果状态指示灯，3 个容量和故障指示灯一直呈红色，则说明检测到了故障。请参考“2.6 指示灯”获取更多信息。

2.3

插入和拔出电池

锂电池

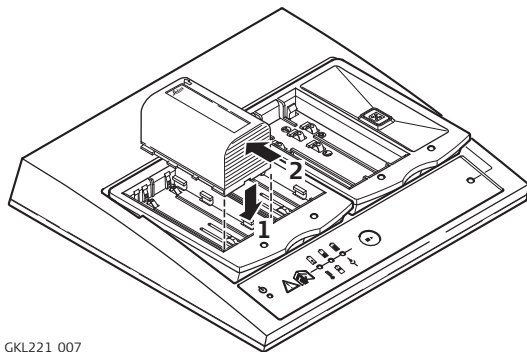

GKL221.007

插入：

1. 将电池插入 GDI221 电池槽的前端。
2. 轻轻将电池向下推到停平点。

拔出：

- 向后推动电池，然后拔出。



仅为 Leica Geosystems 推荐的电池充电或放电。仅使用 Leica Geosystems 的锂电池。

镍镉和镍氢电池

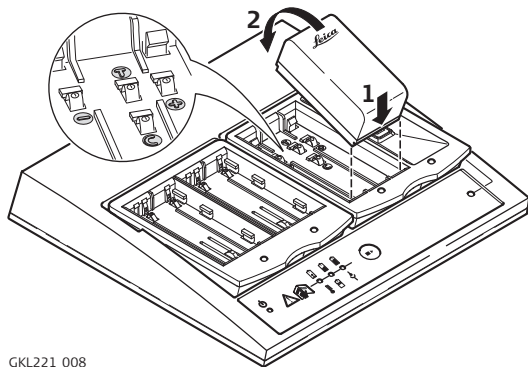

GKL221_008

插入：

1. 将电池插入 GDI222 电池槽的前端。
2. 向下按压直到卡到位置上。

拔出：

- 向上拉电池后端，然后拔出。



Leica Geosystems 的 GEB111 和 GEB121 电池有 4 个接触面，但是由第三方厂家生产的摄像机电池只有 3 个接触面。充电器能自动区别两种不同类型的电池，并调整相应的充电流程。



只有 3 个接触面的摄像机电池必须满足一下的参数，以防损坏：

- 电压：6 V
- 电池类型：镍镉或镍氢
- 最低容量：镍镉 1500 mAh，镍氢 1800 mAh
- 兼容的接触有正确的顺序，例如：“+，T，-”在一直线上。

符合这些参数的摄像机电池将会被监控温度并以 1.6 A 的电流充电。

5 针端口电池

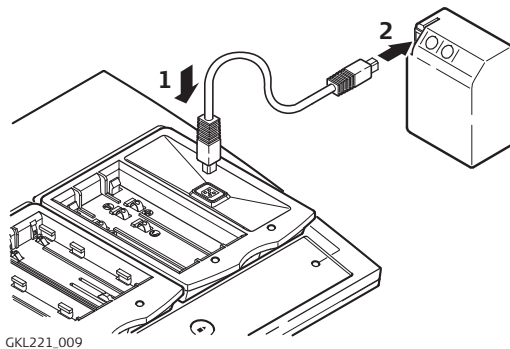

Leica Geosystems 的 5 针充电端口，例如，GEB87 和 GEB70，必须连接到充电电缆的 5 针充电插头。

外接 5 针端口充电电池

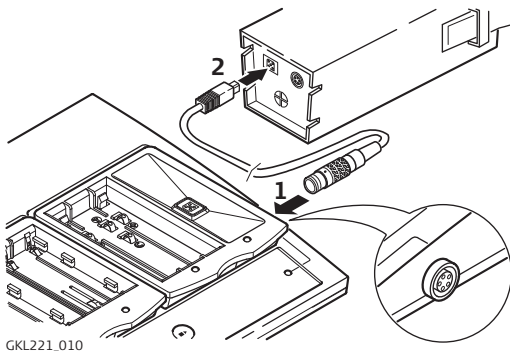

Leica Geosystems 的 5 针端口充电电池，例如，GEB87 和 GEB70，必须连接到充电电缆的外接电池连接插。

 对在外接电池插座上的电池充电时不会终止已经开始的充电进程。

2.4

功能

选择按钮

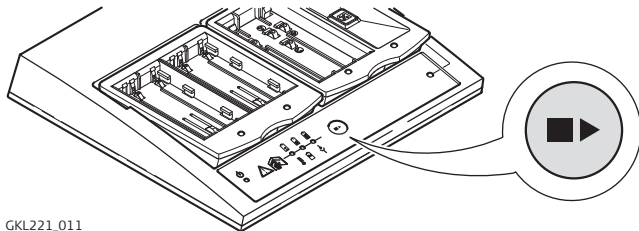

GKL221_011

选择按钮可用于选择充电槽，并切换充电和放电模式。

功能	按住选择按钮	说明
选择充电槽	小于 2 秒	选择下一个有电池的充电槽。选中电池槽对应的黄色状态指示灯会快速闪烁 3 秒；同时会显示电池电量。
充放电模式切换	大于 3 秒	切换到放电模式时，状态指示灯会闪烁黄色 - 红色大约 5 秒的时间，切换到充电模式时，状态指示灯会闪烁黄色 - 绿色大约 5 秒的时间。



红色状态指示灯闪烁表明正在放电。当放电过程完成后，绿色指示灯开始闪烁，表明电池正在充电。

2.5

电池充电

步骤

步骤	说明
1.	插入电池适配器。
2.	将充电器连到供电电源，绿色功能指示灯会亮起来。
3.	插入电池。黄色状态指示灯闪烁表明已识别电池。
4.	确保绿色状态指示灯一直亮着。 电池正在充电中。如果电池连接后，不同的状态指示灯亮着，请参考章节“2.6 指示灯”。  大约 1 分钟后，检查状态指示灯。
5.	在电池充满电后，绿色状态指示灯会开始闪烁。请参考章节“5 技术参数”，获取充电时间的信息。
6.	可以拔出电池或继续放着以保证在需要使用时仍是充满的。详情参见“充电模式”。

设置充电顺序

GKL221 充电器可以同时充两块电池。
当连接不止 1 块电池时，会先充第一个连接的电池。请总是先连接更急需的电池。

属性



外接电池充电不会干扰已经开始的充电流程。

维持满格电量

当电池充满后，仍可以保持连接状态。将会为镍镉和镍氢电池交替充电以维持满格电量。这样可以补足电池自身的放电损失电量，确保在使用时电量是满格的。详情参见“充电模式”。

电池再生



再生功能彻底释放电池的电量，然后迅速充满。

步骤	说明
1.	将充电器连接到供电电源。
2.	插入电池。黄色状态指示灯闪烁表明已识别电池。
3.	按住选择按钮保持大于三秒钟开始释放电池电量。红色状态指示灯闪烁表明正在放电。  大容量电池的放电可能需要较长的时间。为了缩短放电时间，仅在电池没电或电量很低时再使用这个功能。
4.	当电池放电结束后，会开始快速充电。状态指示灯呈绿色。
5.	在电池充满电后，绿色状态指示灯会开始闪烁。
	当镍镉或镍氢电池容量开始明显缩减时，我们建议您进行 2 到 3 次的再生。
	对锂电池，进行一次充放电循环便可。当充电器或在徕卡产品上指示的电池容量明显偏离可用的实际电池容量时，我们建议您进行一次完整的充放电。



2.6

指示灯

符号说明



符号	含义
	LED 关闭.
	LED 一直亮着.
	LED 闪烁.

操作指示灯

符号	LED	含义
	关闭	充电器未连接到供电电源.
	绿色	充电器连接到供电电源.

状态指示灯

符号	LED	含义
	关闭	未识别连接的电池.
	黄色	已识别连接的电池. 充电器在待机模式, 两块其它电池正在充电或放电.
	绿色	连接的电池正在充电中.
	绿色	连接的电池已充满, 可以拔出.
	红色	充电器检测出存在故障.





符号	LED	含义
	红色	已连接要再生的电池。 电池正在放电中。
	黄色	表明当前激活的，选中的充电槽。

电量和故障指示灯

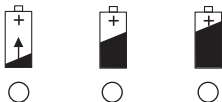
- 在正常工作时，3 个电量和故障指示灯呈绿色，以表明选中的充电槽中电池的电量。在选择充电槽后，指示灯亮 10 到 15 秒之后熄灭。
- 在发生故障时，电量和故障指示灯呈红色，表明选中的充电槽存在故障。

电量指示灯









LEDs	含义
	电池充电低于 20%.
	电池充电至少 20%.
	电池充电至少 50%.
	电池充电至少 80%.

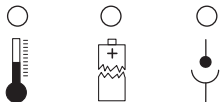

目前，电池电量显示仅针对于 Leica Geosystems 的 GEB211, GEB212, GEB221, GEB222, GEB241, GEB242 和 GEB90 电池。

故障指示灯



LED	含义	采取措施
 ○ ○	电池温度过低或过高。	详情参见“温度范围”。
○  ○	电池损坏。	使用其它电池
○ ○ 	电池或电池适配器上的接触头有故障。	检查检查接触头。
  	充电器硬件故障。	联系 Leica Geosystems 授权的维修部门。



如果当电池连接的时候充电器显示故障：

- 连接一块不同的电池来检查故障存在于电池还是充电器。
- 如果问题仍然存在，联系 Leica Geosystems 授权的维修部门。



在发生故障时，请同时检查：

- 电源或车载电池组是否在供电。
- 所有电缆是否连接正确并未检测出明显的故障。
- 连接的车载适配器上的功能指示灯是否亮着。

2.7

提示

提示

-
- 为了使电池充到最大容量，新的镍镉和镍氢电池需要完全充放电 3 到 5 次。
 - 让仪器中的电池尽量释放完电量。这能防止镍镉电池的“记忆效应”。
 - 当使用车载适配器充电时，请让发动机一直运行着。
-



当充电时避免突发的外界温度变化（例如，避免太阳直晒电池或充电器）。突发的外界温度改变可能引起充电过程在未完成的情况下终止。

3

保养与运输

3.1

运输

运输

当使用铁路、飞机、船舶运输时，要使用完整的徕卡测量系统的原包装（仪器箱和纸箱），或同等的包装物品以避免震动和冲击。

3.2

存储

仪器

当存放仪器时，尤其是夏天仪器存放在汽车等运输工具里，一定要注意温度范围的限制。参见以获取温度限制的信息“5 技术参数”。

3.3

清洁与干燥

仪器

清洁仪器时请使用干净柔软的布，亚麻布除外。

电缆和插头

保持插头清洁、干燥，吹去连接电缆插头上的灰尘。

4

安全指南

4.1

概述

说明

以下的说明可以保证产品责任人和仪器使用者避免操作危害。

产品责任人务必确保所有仪器使用者了解并遵守这些说明。

4.2

目的

允许使用

- 不同技术电池的充电和放电。

使用禁忌

- 不按手册要求使用仪器。
- 超范围使用仪器。
- 仪器安全系统失效。
- 无视危险警告。
- 在特定的许可范围外，用工具如螺丝刀拆开仪器。
- 修理或改装仪器。
- 误操作以后继续使用仪器。
- 仪器有明显的损坏和缺陷仍继续使用。
- 实现未经徠卡测量系统同意而使用其它厂商生产的附件。

警告

违禁使用，可能会损坏仪器或造成人身伤害。产品负责人有义务告知用户可能存在的危害及其预防措施。使用者直到学会如何正确使用仪器后，才能实际操作。

4.3

使用限制

环境条件

仅在干燥环境下使用，避免不利环境。

4. 4

责任范围

产品制造商

Leica Geosystems AG, CH-9435 Heerbrugg 以下简称徕卡测量，对其供应的产品，包括用户手册和原始附件的安全负责。

非徕卡测量制造商生产的附件

非徕卡测量产品附件的制造商对其产品的研发、生产和通讯安全负责，并同时负责这些附件与徕卡测量的设备配套后的安全标准的有效性。

仪器负责人

仪器负责人有以下职责：

- 熟悉产品的安全指南和用户指南中的说明
- 熟悉当地的安全事故预防规则。
- 如果测量仪器出现安全问题，请立即联系徕卡测量。



警告

仪器负责人要保证按照说明来使用仪器。同时他也对培训和调度使用人员及对仪器在使用中的安全负责。

4. 5

使用中存在的危险



警告

使用说明书的缺失或错误解释都可能导致误操作，造成人力、物力、财力的浪费，甚至会给外界环境带来不良后果。

预防：

所有使用者必须遵循厂商和仪器负责人给出的安全指导。



警告

测量产品不能在潮湿和不利环境中使用。潮湿的设备可能引起触电。

预防：

仅在干燥环境中使用产品，比如在室内或车内。注意产品的防潮。如果产品不慎弄湿，请不要使用！



警告

如果您拆开产品，以下任一操作都可能引起触电。

- 触摸裸露部件
- 在非正确修理产品后使用。

预防：

不要拆开产品。只有徕卡测量授权的维修部门才有资格对仪器设备进行维修。



警告

对非 Leica Geosystems 推荐的电池充放电可能造成电池损坏。电池可能烧毁或爆炸。

预防：

仅对 Leica Geosystems 推荐的电池进行充放电。



警告

如果仪器设备使用不当，会出现以下情况：

- 如果聚合材料的部件被燃烧，将产生有毒气体，其可能有损健康。
- 如果电池受损或过热，会引起燃烧，爆炸，腐蚀及污染环境。
- 若不负责任地处理仪器，在违反规章制度的情形下让未经授权的人使用仪器，从而使他们或第三方人员面临遭受严重伤害的风险并使环境容易遭受污染。

预防：

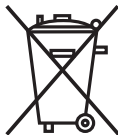

仪器和附件不应与家庭废弃物一起处理。
应按照国家实施的规章适当地处置。
防止未经授权的个人接触仪器。

有效处理仪器和附件及管理废弃物的信息可以从徕卡主页 <http://www.leica-geosystems.com/treatment> 中下载或从本地徕卡经销商处索取。

部件名称	有毒有害物质或元素					
	铅	汞	镉	六价铬	多溴联苯	多溴二苯醚
外壳	0	0	0	0	0	0
螺丝	0	0	0	0	0	0
主集成电路板	X	0	0	0	0	0
0: 表示该有毒有害物质在该部件所有均质材料中的含量均在 SJ/T11363-2006 标准规定的限量要求以下						
X: 表示该有毒有害物质至少在该部件的某一均质材料中的含量超出 SJ/T11363-2006 标准规定的限量要求						

4.6

电磁兼容性 EMC

说明

术语电磁兼容性是指产品在存在电磁辐射和静电放电的环境中正常工作的能力，以及不会对其他设备造成电磁干扰。

警告

电磁辐射可能会对其它设备产生干扰。

虽然产品是严格按照有关规章和标准生产的，但是徠卡测量也不能完全排除其它设备被干扰的可能性。

注意

如果产品用于第三方部件可能造成其它设备故障，例如，第三方电缆或外接电池。

预防：

仅使用徠卡测量推荐的设备和附件。当与其它产品相连时，确信它们严格满足指南或标准的规定。



警告

如果仪器仅连接电缆两个端口中的一个，如外接供电电缆，接口连接电缆，而另一端裸放，则电磁辐射可能会超量，还可能会削弱其它产品的正常功能。

预防：

使用电缆时，电缆两端的接头应全部连接好，如：仪器到外电池的连接、仪器到计算机的连接等。

4.7

FCC 声明，适用于美国



警告

依照 FCC 法规的第 15 部分，经测试此仪器符合 B 类数字设备的要求。

这些限制合理地保护了居住区设施不受干扰。

此仪器产生、使用无线电波，同时会释放射频能量，因此如果未按照说明安装和使用，它可能会对无线通讯设备造成干扰。

即使按照说明进行特殊安装，我们仍不能完全保证避免这些干扰。

可以通过打开和关闭仪器设备来测试是否仪器对无线电或电视接收设备产生有害影响，如果确实存在，用户可按以下操作消除干扰：

- 重新调节接收天线的方向或位置。
 - 拉大仪器和接收机间的距离。
 - 把仪器连接到与接收机不同的电路接口上。
 - 向经销商或有经验的收音机、电视机的技术人员进行咨询，寻求帮助。
-



警告

为保障用户的权利，徠卡测量并不赞同用户自行更改或改装仪器。

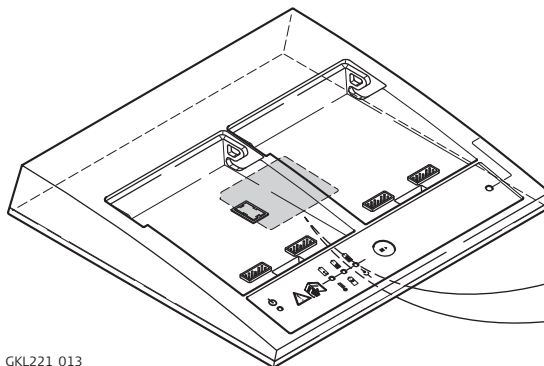

GKL221_013

Type: GKL221

Art.No.:

.....
.....
.....
.....
.....
.....
.....

This device complies with part 15 of the FCC Rules. Operation is subject to the following two conditions: (1) This device may not cause harmful interference, and (2) this device must accept any interference received, including interference that may cause undesired operation.

供电	<ul style="list-style-type: none"> 电源连接, ~ D/C 电压连接, ==
输入电压	<ul style="list-style-type: none"> 100 - 240 VAC, 50/60 Hz 24VDC
充电功率	最大 18 VDC / 最大 4.0 A; 取决于电池类型
放电	4 W
额定功率	~ : 75 W == : 55 W
操作环境	仅在干燥环境中操作, 例如, 室内或车内 IP40, 遵照 IEC60529
温度范围	存储: -40° C - +70° C -40° F - +158° F 操作: ~ : 0° C - +40° C +32° F - 104° F == : 0° C - +50° C +32° F - 122° F
充电模式	快速充电 模式可用于: <ul style="list-style-type: none"> 所有 Leica Geosystems 电池. 可以监视温度和识别电池. 充电电流最大为 4.0 A, 取决于电池. 所有标准的 3 接触面摄像机电池和温度监视. 充电电流最大: 1.6 A 正常充电 模式可用于: <ul style="list-style-type: none"> 镍镉和镍氢电池, 温度低于 +10° C. 锂电池, 温度低于 +6° C 接近或完全没电的锂电池, 镍镉电池盒镍氢电池.

保护充电模式用于：

- 镍镉和镍氢电池。充电电流取决于电池类型。每块电池轮流充 15 秒。



充电技术

锂电池不需要保护充电，因为它们不会在不使用时损耗电量。

在快速充电模式关闭条件：

对于镍镉和镍氢电池：

计时器
电量
电池温度
负电压差
每分钟温度增加
双调方法

对于锂电池：

计时器
电量
电池温度
充电电流

镍镉和镍氢电池的保护充电：

监视电池电压，充电电流和电池温度。

电池类型

- 镍镉电池
- 镍氢电池
- 锂电池

充电和放电时间

充放电时间主要取决于充放电的电流，连接时电池的电量 and 充电状态。

下面给出了大致指南：

20° C 快速充电：

镍镉电池

最大 2200 mAh 1.0 - 1.5 h

最大 7200 mAh 2.5 - 4.0 h

镍氢电池

最大 2200 mAh 1.5 - 2.0 h

最大 4900 mAh 2.0 - 2.5 h

最大 10000 mAh 2.5 - 5.5 h

锂电池

最大 4600 mAh 2.5 - 3.5 h

放电：

对于镍镉和镍氢电池

6V 电池 600 mAh 每小时

12V 电池 300 mAh 每小时

锂电池

7.4V 电池 500 mAh 每小时

指示灯

请参阅章节“2.6 指示灯”。

重量

充电器包含两个电池适配器：1.12 kg

尺寸

长 x 宽 x 高：最大 237 mm x 227 mm x 43 mm；包含电池适配器

Leica GKL221 충전기 사용자 매뉴얼

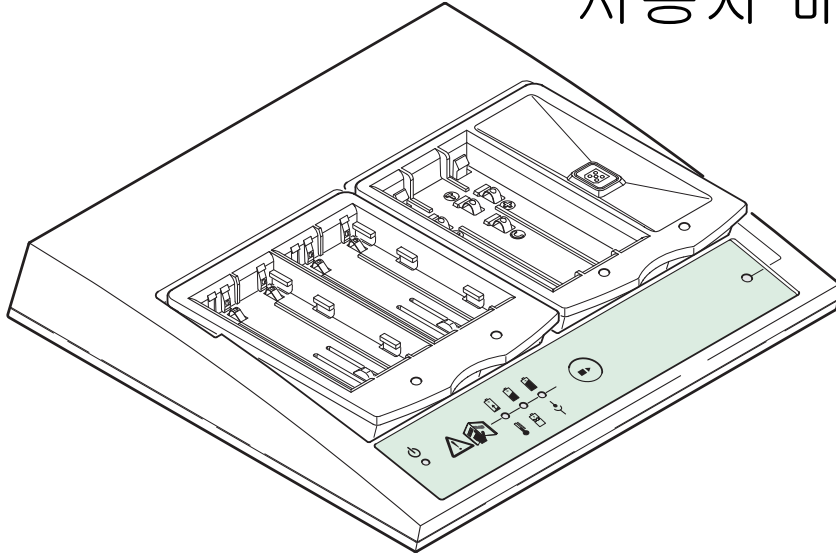

버전 1.3
한글

- when it has to be **right**

Leica
Geosystems

소개



이 매뉴얼은 장비 세팅, 작동법 & 중요한 안전지침 사항을 포함하고 있습니다. 더 많은 정보는 "4 안전 지침"을 참조하십시오. 제품 사용전에 이 매뉴얼을 정독하십시오.

장비 증명서





제품의 모델 & 고유 번호는 제품 뒷면에 있습니다. 모델 및 고유번호를 매뉴얼에 기입하십시오. 이 내용은 공인 서비스센터에서 서비스시 요청시 필요합니다.

종류 : _____

시리얼 넘버 : _____

심볼

이 매뉴얼에 사용된 심볼은 다음과 같습니다 :

종류	설명
 위험	매우 위험한 상태이며 부주의한 사용시 사망 또는 심각한 부상을 초래할수 있음
 경고	위험 요소가 잠재되어 부주의한 사용시 사망 또는 심각한 부상을 초래할수 있음
 주의	위험 요소가 잠재되어 부주의한 사용시 경미한 부상 또는 물질적, 금전적, 환경피해를 초래할수 있음
	정확하고 효과적으로 제품을 사용할수 있도록 기술적으로 숙지해야 할 중요한 내용들

목차 테이블

이 매뉴얼	챕터	페이지
	1 시스템 설명	4
	2 작동	8
	2.1 배터리 아답터	8
	2.2 충전기 연결	9
	2.3 배터리 삽입 및 분리	10
	2.4 선택 버튼	13
	2.5 배터리 충전	13
	2.6 표시등	16
	2.7 팁	19
	3 주의 & 운송	20
	3.1 운송	20
	3.2 보관	20
	3.3 청소 & 건조	20
	4 안전 지침	21
	4.1 일반사항	21
	4.2 목적	21
	4.3 사용 제한	22
	4.4 책임 범위	22
	4.5 위험한 사용	22
	4.6 전자파 적합성 EMC	24
	4.7 FCC 인증, (US 적용)	24
	5 기술 사양	26

1

시스템 설명

설명 라이카 지오시스템즈 GKL221 은 특수한 충전 테크놀러지를 장착한 인텔리전트 충전기입니다 . 모든 라이카 배터리를 충전하도록 제작되었습니다 . GDC221 는 AC 케이블 또는 차량 아답터를 사용하여 전원을 공급합니다 .GKL221 는 라이카 지오시스템즈 모든 배터리에 사용 가능합니다 .

일반 정보 충전기에 최대 5 개의 배터리를 연결할수 있습니다 . 2 개의 배터리가 동시에 충전됩니다 . 2 개 이상 배터리 연결시 연결된 순서로 충전됩니다 .
배터리 충전 , 방전 , 갱신 기능이 있습니다 .



작업 지침을 읽으면서 제품을 사용해보십시오 .

시스템 구성 요소

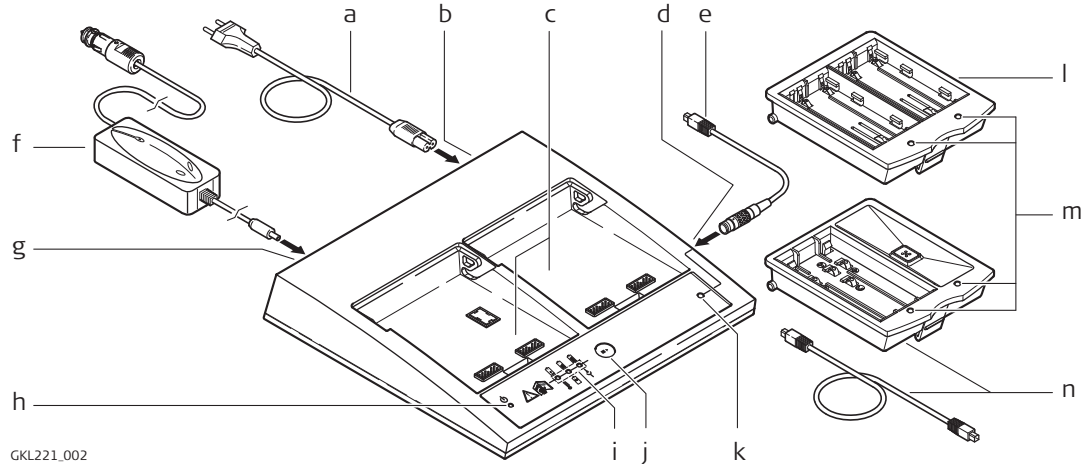

GKL221_002

- | | |
|---|------------------------------------|
| a) AC 케이블, 국가별 다름 | h) 기능 표시등 |
| b) 충전기 AC 케이블 소켓 | i) 용량 및 에러 표시등 |
| c) 아답터 베이 I, II - GDI221 / GDI222 배터리 아답터 | j) 선택 버튼 |
| d) 외장 배터리 케이블 연결 | k) 외장 배터리 연결 상태 표시등 |
| e) 외장 5 핀 배터리 케이블 소켓 | l) GDI221 배터리 아답터, 옵션 |
| f) 차량 아답터 GDC221, 옵션 | m) 배터리 상태 표시등 |
| g) 충전기 차량 케이블 소켓 | n) GDI222 배터리 아답터 및 5 핀 충전 케이블, 옵션 |

충전 배터리

다음 Leica Geosystems 배터리를 충전할수 있습니다 :

GEB90
GEB211
GEB212
GEB221
GEB222
GEB241
GEB242



GEB111
GEB121

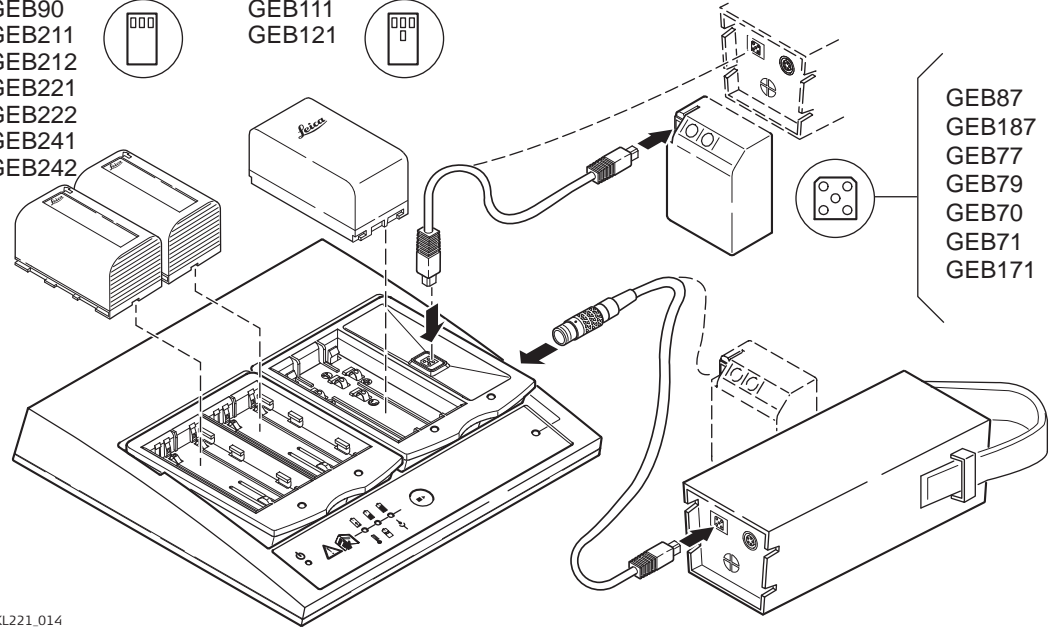

GEB87
GEB187
GEB77
GEB79
GEB70
GEB71
GEB171

GKL221_014



오리지널 라이카 배터리 및 NiMH/NiCd 캠코더 배터리를 충전 및 방전하는 충전기입니다. 자세한 정보는 "2.3 배터리 삽입 및 분리" 섹션을 참조하십시오.

충전기 및 배터리 아답터

배터리 아답터를 사용한 충전기에 다음 배터리를 사용할수 있습니다 :

충전기 / 배터리 아답터	충전 배터리
GKL221 - 2 X GDI221	최대 4 X Li-Ion 배터리 & 1 X 5 핀 소켓 배터리
GKL221 - 1 X GDI221 & 1 X GDI222	최대 2 X Li-Ion 배터리 , 1 X 캠코더 배터리 & 2 X 5 핀 소켓 배터리
GKL221 - 2 X GDI222	최대 2 X 캠코더 배터리 & 3 X 5 핀 소켓 배터리

2

2.1

작동

배터리 아답터

목적

배터리 아답터는 충전기를 관련 배터리와 연결하며 충전 소켓당 배터리 상태를 나타내는 LED 1 개를 갖습니다 .

종류

다음 배터리 아답터를 사용할수 있습니다 :

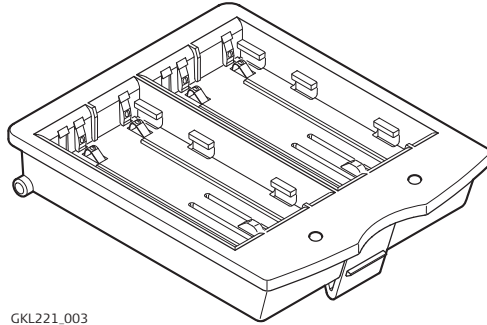

GKL221_003

GDI221

- 2 X Leica Geosystems Li-Ion 배터리 GEB90, GEB211, GEB212, GEB221, GEB222, GEB241, GEB242.

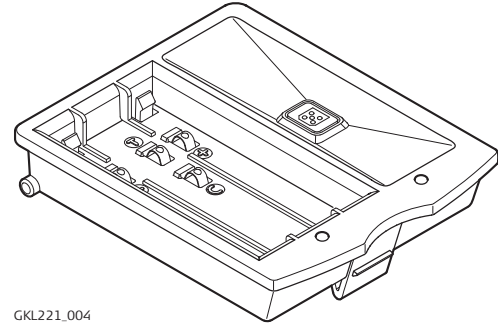

GKL221_004

GDI222

- 1 X Leica Geosystems NiMH 배터리 GEB111 또는 GEB121, 1 X NiCd 또는 NiMH 5 핀 배터리

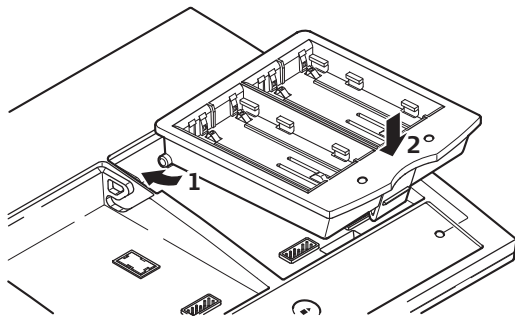

GKL221_005

결합

1. 배터리 아답터를 가이드 구멍에 결합합니다 .
2. 배터리 아답터를 소리날때까지 눌러 올바르게 결합합니다 .

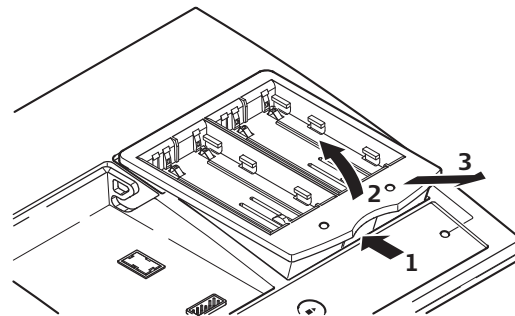

GKL221_006

분리

1. 배터리 아답터 전면 버튼을 누릅니다 .
2. 멈출때까지 조심히 위로 올립니다 .
3. 아답터를 앞으로 당겨 분리합니다 .

2.2

충전기 연결



경고

건조한 실내에서만 충전기를 사용하십시오 ! 충전기가 젖어 있으면 사용하지 마십시오 !

시작

충전기를 단단한 표면에서만 사용하십시오 .

다음과 충전기를 연결하십시오 :

- 제공된 메인 전원 케이블 사용 또는
- GDC211 차량 케이블 (옵션)



충전기를 오랫동안 사용하지 않으시면 AC 전원 및 차량 전원 소켓에서 분리하십시오 .



차량에서는 차량용 전원 케이블만 사용하십시오. 변합기를 사용하여 전원 공급시, 고장날수도 있습니다. 전력 및 전압 정보는 "5 기술 사양" 을 참조하십시오.



오래된 차량에서는 시가렛 소켓 중간에 + 가 있는지 확인하십시오. 극성이 틀리면 충전기 또는 차량 아답터의 퓨즈를 변경해야 합니다. 충전기 소켓 퓨즈는 Leica Geosystems 공인 서비스 센터에 문의하십시오. 차량 아답터의 퓨즈 변경 방법은 매뉴얼 아답터에 설명되어 있습니다.

기능 확인

아답터가 전원 또는 차량 소켓 과 연결시 빨강, 노랑, 초록 기능 표시등이 한번 반짝입니다. 에러 발생시 빨강 및 초록이 반짝입니다. 이것이 기능 체크입니다.
 배터리 미삽입시 초록 기능 표시등만 켜집니다.
 상태, 3 X 용량, 에러 표시등이 켜진후 빨개지면 에러가 감지된것입니다. 추가 정보는 "2.6 표시등" 섹션을 참조하십시오.

2.3 배터리 삽입 및 분리

Li-Ion 배터리

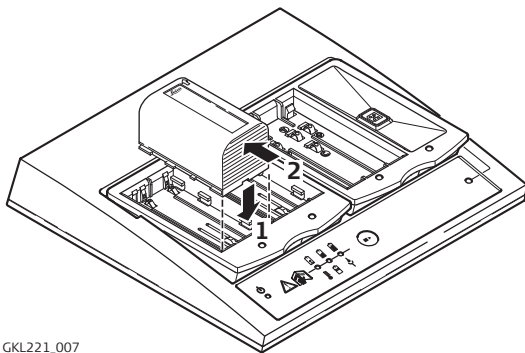

삽입 :

1. 배터리 연결부를 GD1221 배터리 소켓에 놓습니다.
2. 올바른 위치에 갈때까지 살짝 누릅니다.

분리 :

- 배터리 후면을 당겨 분리합니다.

⚠ 경고

Leica Geosystems 에서 인증한 배터리 충전기를 사용하십시오 . Leica Geosystems Li-Ion 배터리만 사용하십시오 .

NiCd 및 NiMH 배터리

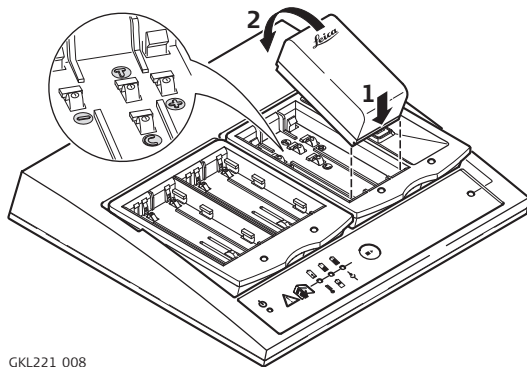

GKL221_008

삽입 :

1. 배터리 연결부를 GDI222 배터리 소켓에 놓습니다 .
2. 올바른 위치에 들어갈때까지 살짝 누릅니다 .

분리 :

- 배터리 후면을 당겨 분리합니다 .



Leica Geosystems GEB111 및 GEB121 배터리는 4 개 연결부가 있습니다 . 반면에 타사 캠코더 배터리는 3 개 연결부만 있습니다 . 충전기는 이 두가지 배터리를 구분하며 각각 충전합니다 .



3 개 접합부를 갖은 캠코더 배터리는 다음 조건을 준수해야합니다 :

- 전압 : 6 V
- 배터리 종류 : NiCd, NiMH
- 최소 용량 : NiCd 1500 mAh, NiMH 1800 mAh
- 올바른 핀순서 , 예시) "+, T, -" 일렬 배열

캠코더 배터리의 전력은 1.6 A 를 준수해야합니다 .

KO

5 핀 소켓 배터리

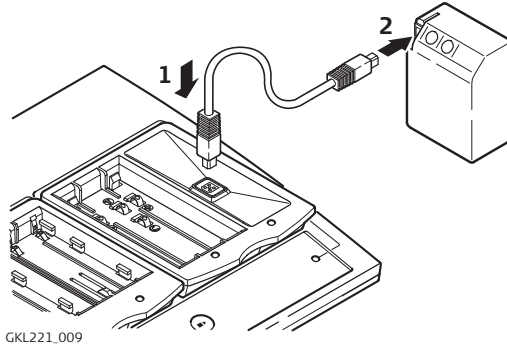

Leica Geosystems 배터리에 5 핀 충전 소켓이 있습니다, 예시) GEB87, GEB70 는 충전 케이블을 사용한 5 핀 소켓에 연결됩니다 .

5 핀 충전 소켓 외장 배터리

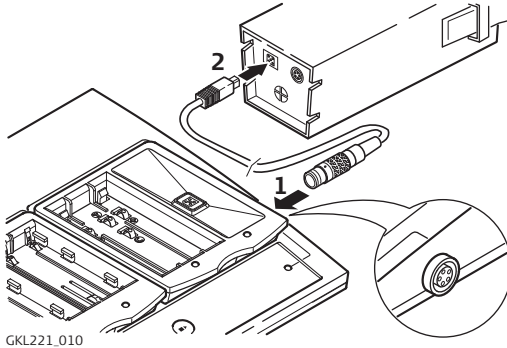

Leica Geosystems 배터리에 5 핀 충전 소켓이 있습니다, 예시) GEB87, GEB70 는 충전 케이블을 사용한 외장 배터리 연결 소켓에 연결됩니다 .

☞ 외장 배터리 연결 소켓의 배터리는 다른 소켓 충전과 관련없이 충전됩니다 .

2.4

선택 버튼

기능

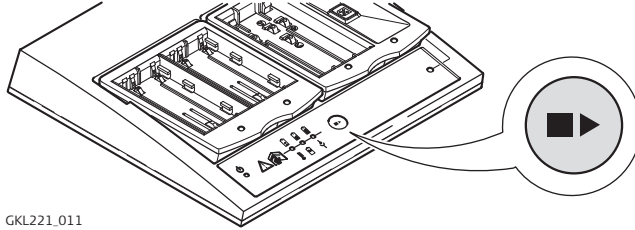

배터리 선택 및 충전 및 방전 모드로 변경 시 선택 버튼을 사용합니다.

GKL221_011

기능	선택 버튼 누름	설명
충전 배터리 선택	2 초 미만	배터리가 삽입된 배터리 선택. 선택 배터리의 노란 표시등이 3 초 동안 빠르게 반짝입니다; 배터리 용량도 표시됩니다.
충전 및 방전 모드 변경	3 초 이상	방전 모드 변경시 5 초간 노랑 - 빨강 표시등이 반짝입니다, 충전 모드 변경시 5 초간 노랑 - 초록 표시등이 반짝입니다.



방전 모드에서 빨강 상태 버튼이 반짝입니다. 방전 과정 완료시 초록 표시등이 반짝이기 시작하며 배터리 충전이 시작됩니다.

2.5

배터리 충전

과정

단계	설명
1.	배터리 아답터를 결합합니다.
2.	충전기에 전원을 공급합니다, 초록 표시등이 켜집니다.
3.	배터리를 삽입합니다. 노란 표시등이 반짝이며 배터리 인식을 의미합니다.

KO

단계	설명
4.	초록 표시등이 켜져있는지 확인하십시오 . 배터리 충전중입니다 . 연결후 배터리에 다른 상태등이 켜져있으면 "2.6 표시등 램프 " 섹션을 확인하십시오 .  약 1 분후 상태 표시등을 확인하십시오 .
5.	초록 표시등이 반짝이면 배터리가 완충된것입니다 . 충전 시간 정보는 "5 기술 사양 " 을 참조하십시오 .
6.	배터리 분리 또는 그냥 놓으십시오 . 자세한 정보는 " 충전 모드 " 섹션을 참조하십시오 .

충전 순서 설정

GKL221 충전기는 2 개 배터리를 동시 충전할수 있습니다 .
1 개 이상 배터리가 연결되어 있으면 먼저 연결된 배터리부터 충전됩니다 . 중요한 배터리부터 연결하십시오 .

우선 사항



외장 배터리는 충전 순서에 관계없이 충전됩니다 .

완충 유지

배터리 완충시 배터리는 연결되어 있습니다 . NiCd, NiMH 배터리는 완충 상태를 유지하기 위해 계속 충전됩니다 . 이 방식을 적용하여 고유의 자동 방전 기능이 실행되며 배터리는 항상 사용 가능한 완충 상태를 유지합니다 . 자세한 정보는 " 충전 모드 " 섹션을 참조하십시오 .

배터리 갱신



갱신 기능은 배터리 완전 방전후 빠르게 충전하는 기능입니다 .

단계	설명
1.	충전기 전원을 연결합니다 .
2.	배터리를 삽입합니다 . 노란 표시등이 반짝이며 배터리 인식을 의미합니다 .
3.	3 초 이상 선택 버튼을 누르시면 배터리 방전 단계가 시작됩니다 . 방전 모드에서 상태 버튼이 빨갈게 반짝입니다 .  방전 시간은 용량에 비례합니다 . 방전 시간을 줄일려면 배터리가 완방 되었거나 낮을때 사용하시면됩니다 .
4.	배터리 완전 방전시 빠른 충전이 가능합니다 . 상태 표시등은 초록이 됩니다 .
5.	초록 표시등이 반짝이면 배터리가 완충된것입니다 .
	배터리가 빠르게 방전된다고 생각되시면 NiCd, NiMH 배터리를 2~3 회 갱신하십시오 .
	Li-Ion 배터리는 1 회 방전 & 충전 사이클로 충분합니다 . 라이카 지오시스템즈에서 제공하는 배터리 실제 사용 시간만큼 작동을 하지 못하면 배터리를 갱신하십시오 .



2.6

표시등





심볼 의미

심볼	의미
	LED 꺼짐
	LED 켜짐
	LED 반짝임

작동 표시등

심볼	LED	의미
	꺼짐	충전기 전원 미연결
	초록	충전기 전원 연결

상태 표시등

심볼	LED	의미
	꺼짐	연결된 배터리 미인식
	노랑	배터리 인식 완료 . 충전기가 대기 모드이며 다른 두개 배터리가 충전 및 방전 모드입니다 .
	초록	연결된 배터리 충전중
	초록	연결된 배터리가 완충되었으며 분리 가능합니다 .
	빨강	충전기 에러 감지

심볼	LED	의미
	빨강	갱신될 배터리가 연결되었습니다 . 배터리 방전중
	노랑	활성화된 배이 표시

용량 및 에러 표시등

- 일반 작업시 3 용량 및 에러 표시등이 초록이며 선택한 배이의 배터리를 표시합니다 . 배이 선택 후 표시등은 10~15 초간 반짝인 후 꺼집니다 .
- 에러 발생시 용량 및 에러 표시등이 빨강이되며 선택한 배이에 에러를 나타냅니다 .

용량 표시등









LED	의미
○ ○ ○	배터리 20% 미만
○ ○	배터리 약 20%
○	배터리 약 50%
	배터리 약 80%

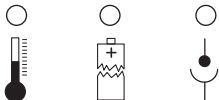

Leica Geosystems GEB211, GEB212, GEB221, GEB222, GEB241, GEB242, GEB90 배터리만 용량이 표시됩니다 .

에러 표시등



LED	의미	조치 사항
 ○ ○	배터리가 너무 차거나 뜨겁습니다 .	추가 정보는 " 온도 범위 " 섹션을 참조하십시오 .
○  ○	배터리 불량입니다 .	다른 배터리를 사용하십시오 .
○ ○ 	배터리 접합부 또는 배터리 소켓이 잘못되었습니다 .	접합부를 확인하십시오 .
  	충전기 하드웨어 에러	Leica Geosystems 공인 서비스 센터에 문의하십시오 .



배터리 연결시 충전기가 에러를 나타내면 :

- 배터리 또는 충전기 잘못인지 확인하기 위해 다른 배터리를 연결해보십시오 .
- 문제가 계속된다면 Leica Geosystems 공인 서비스 센터에 문의하십시오 .



에러 발생시 확인 사항 :

- AC 전원 또는 차량 전원을 확인해보십시오 .
- 케이블이 올바르게 연결되었는지 확인하십시오 .
- 아답터가 올바르게 연결되었는지 확인하십시오 .

2.7

팁

팁

- 새로운 NiCd, NiMH 배터리 용량을 올바르게 사용하려면 방전 및 충전을 3~5 회 반복하십시오 .
- 장비에 있는 배터리의 방전 과정을 많이 하십시오 . 이 작업은 소위 NiCd 배터리의 소위 " 메모리 효과 " 를 방지합니다 .
- 차량 아답터를 사용하여 충전시 차량 시동을 걸어두십시오 .



배터리 충전시 갑작스런 온도 변화를 피하십시오 (예시 - 배터리 및 충전기를 직사광선에 놓지 마십시오). 갑작스런 온도 변화에 배터리가 완충 되지 않을수 있습니다 .

3 주의 & 운송

3.1 운송

선적 철로, 항공, 바다를 이용하여 장비 운송시 팩키지 박스를 사용하여 운반시 발생할수 있는 충격 & 진동을 흡수할수 있도록 하십시오.

3.2 보관

장비 장비 보관시 온도를 준수하십시오. 특히 여름에 장비를 차량에서 보관하는 것은 장비에 좋지 못한 영향을 미칠수 있습니다. 온도 한계에 정보는 "5 기술 사양" 섹션을 참조 하십시오.

3.3 청소 & 건조

장비 청소시 부드러운 보풀 방지 천을 사용하십시오.

케이블 & 플러그 플러그를 깨끗하고 건조한 곳에서 보관하십시오. 연결된 플러그에 있는 먼지를 제거하십시오.

4

안전 지침

4.1

일반사항

설명

다음 사항은 장비 관리자 및 실사용자가 인지하고 있어야 합니다 .

장비 책임자는 이 주의 사항을 사용자에게 정확히 인지시켜야 합니다 .

4.2

목적

적합한 사용

- 배터리 충전 및 방전

잘못된 사용

- 교육없이 장비 사용
- 사용 목적외 사용
- 위험한 환경에서 사용
- 위험 경고를 무시한 사용
- 무허가 장비분해 및 조립
- 장비의 수정 및 변경
- 도난품 사용
- 파손된 장비 사용
- 라이카 지오시스템즈 미승인 타사 악세사리 사용



경고

잘못된 사용은 부상, 기능장애, 파손 등을 야기 할수있습니다 . 장비 사용시 발생할수 있는 위험과 위험을 예방 할수있는 방법을 장비책임자가 사용자에게 알려야합니다 . 장비 교육을 완전히 받은 후에 장비를 사용하셔야 합니다 .

4.3

사용 제한

환경

건조한 환경에서 사용이 적합하며 악천우를 피하십시오 .

4.4

책임 범위

제품 생산자

Leica Geosystems AG, CH-9435 Heerbrugg. 이하 라이카 지오시스템즈는 매뉴얼, 오리지널 악세사리를 포함한 제품 공급의 책임이 있습니다 .

비 라이카 지오시스템즈 악세사리 사용자

라이카 지오시스템즈 악세사리를 생산하는 타업체는 제품의 안전, 개발, 통신, 기능 관련 책임이 있으며, 라이카 지오시스템즈 장비와 함께 사용했을때 발생하는 모든 문제 및 기능에 책임이 있습니다 .

제품 책임자

제품 책임자는 다음 의무를 갖습니다 :

- 사용자 매뉴얼에 명기된 제품의 안전 지침 사항을 인지해야 합니다 .
- 안전과 사고방지에 대한 규정에 익숙해야 합니다 .
- 제품이 안전하지 못한 상황이면 라이카 지오시스템즈에 즉시 알려야 합니다 .

경고

장비 책임자는 사용 방법을 준수해야 합니다 . 장비 책임자는 장비교육, 장비사용자의 배치, 안전사고 방지의 책임이 있습니다 .

4.5

위험한 사용

경고

취급 설명서를 따르지 않거나 소홀할 경우에 잘못된 사용 또는 부적절한 사용을 할수있습니다 . 이는 인명 피해, 물질 피해, 금전적 피해 및 환경적으로 여러가지 사고를 발생시킬수 있습니다 .

예방 :

모든 사용자는 안전지침사항을 인지하고 책임자의 지시를 따르십시오 .

 경고

습한 장소 및 악천우에서 제품을 사용할수 없습니다 . 제품이 습하게 되면 전자 쇼크를 받을수 있습니다 .

예방 :

빌딩 및 차량과 같은 건조한 지역에서 제품을 사용하십시오 . 제품을 습하지 않게 하십시오 . 제품이 습하면 사용하지 마십시오 !

 경고

제품을 상자에서 분리하여 다음 작업시 장비에 충격이 가할수 있습니다 .

- 부품을 만지지 마십시오 .
- 비 정상 방법으로 제품 수리

예방 :

제품을 뜯지 마십시오 . 라이카 지오시스템즈 공인 서비스 선테만이 제품을 수리할수 있습니다 .

 경고

Leica Geosystems 비 승인 배터리 충전 및 방전은 제품에 충격을 가할수 있습니다 . 폭발 가능성이 있습니다 .

예방 :

Leica Geosystems 추천 배터리만 충전 및 방전하십시오 .

 경고

제품을 부적절하게 폐기할 경우 다음의 문제가 발생합니다 :

- 화학부분 소각되면서 유해가스가 발생하여 건강에 해로울수 있습니다 .
- 배터리가 파손되었거나 강한열에 노출되면 폭발, 화재, 부식 또는 환경 오염이 발생할수 있습니다 .
- 장비를 방치하면 미승인 사용자가 규정에 어긋나게 장비를 사용할수 있으며 사용자와 타인을 심한 부상위험에 노출시킬수있고 환경오염의 원인이 될수있습니다 .

예방 :

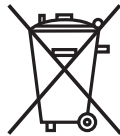

일반 쓰레기와 함께 폐기하지 마십시오 .

국가가 정하는 규정에 따라서 장비를 적합하게 폐기하십시오 .

비승인된 사람의 장비 사용을 금하십시오 .

제품의 처리와 폐기에 관한 정보는 라이카 지오시스템즈 홈페이지 <http://www.leica-geosystems.com> 에서 다운로드 받으시거나 또는 판매처에 문의하십시오 .

4.6

전자파 적합성 EMC

설명

전자파 적합성이란 전자기파 또는 정전기등이 환경에 따라 다른 장치들과 호환되어 올바르게 작동하는 기능을 의미합니다 .

경고

전자파는 다른 장치들의 작동을 방해할수 있습니다 .

엄격한 규격과 이에 따른 규격을 지킨 엄격한 제품일지라도 라이카 지오시스템즈는 다른 장비에 작동을 방해 할수있는 가능성을 완벽하게 제거하지 못하였습니다 .

주의

타사 제품 (케이블 또는 외장 배터리) 과 장비 사용시 제품에 충격이 가해질수도 있습니다 .

예방 :

라이카 지오시스템즈에서 추천한 장비 및 악세사리만 사용하십시오 . 다른 제품과 함께 사용시 가이드라인 , 표준에 명시되어 있는 요구사항을 따르십시오 .

경고

장비와 케이블이 외장 배터리 케이블 , 통신케이블을 사용하여 한쪽만 연결된 상태에서 동작시 허용 전자기파를 초과할수있으며 다른 장비의 올바른 작동을 방해할수 있습니다 .

예방 :

제품에서 사용시 케이블 , 외장 배터리는 양쪽에서 반드시 연결되어야 합니다 .

4.7

FCC 인증 , (US 적용)

경고

이 장비는 FCC 규정 15 절에 따라 엄격히 테스트된 B 등급의 디지털 장비입니다 .

이 기기는 가정용 (B 급) 으로 전자파 적합 등록을 한 기기로서 주로 가정에서 사용하며 모든 지역에서 사용할수 있습니다 .

이 장비는 라디오파 생성 , 사용 , 방출하며 매뉴얼에 따라서 장비를 설치해도 라디오 통신을 간섭할수 도 있습니다 .

특정한 장소에 설치시 간섭이 발생하지 않는다고 보장할수 없습니다 .

장비를 켜고 끝때 라디오 또는 TV 수신시 영향을 미칠 경우 사용자는 다음 방법을 참조하십시오 :

- 수신 안테나 방향을 다시 조정하십시오 .
- 장비와 수신기의 간격을 증가시키십시오 .
- 수신기가 연결된 반대쪽 회로에 장비를 연결하십시오 .
- 판매자나 라디오 /TV 전문가와 상의하십시오 .

경고

라이카 지오시스템즈의 미승인 변경 , 수정은 사용자 장비 작동의 권리에 위배되는 행위이며 적절한 서비스를 받을수 없습니다 .

라벨

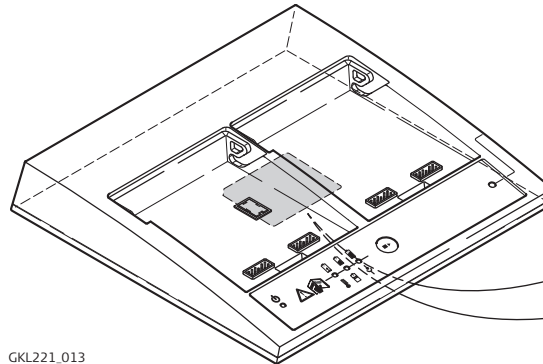

GKL221_013

Type: GKL221

Art.No.:

.....
.....
.....
.....
.....
.....
.....
.....
.....
.....

This device complies with part 15 of the FCC Rules. Operation is subject to the following two conditions: (1) This device may not cause harmful interference, and (2) this device must accept any interference received, including interference that may cause undesired operation.

5

기술 사양

전력 공급	<ul style="list-style-type: none">• 메인 연결, ~• D/C 전압 연결, ==
입력 전압	<ul style="list-style-type: none">• 100 – 240 VAC, 50/60 Hz• 24VDC
충전 전력	최대 18 VDC / 최대 4.0 A; 배터리 종류에 따라 다름
방전	4 W
소비 전력	~ : 75 W == : 55 W
작동 환경	빌딩 및 차량과 같은 건조한 환경에서만 사용 IP40, IEC60529 준수
온도 범위	보관 -40°C ~ +70°C -40°F ~ +158°F 작동 : ~ : 0°C ~ +40°C +32°F ~ 104°F == : 0°C ~ +50°C +32°F ~ 122°F
충전 모드	퀵 충전 모드 : <ul style="list-style-type: none">• Leica Geosystems 모든 배터리 . 온도 모니터링 및 배터리 인식 기능 . 배터리에 따라 최대 4.0 A 충전• 모든 표준 캠코더 배터리 - 3 접합부 및 온도 모니터링 최대 1.6 A 충전 일반 충전 모드 : <ul style="list-style-type: none">• NiCd, NiMH 배터리 : +10°C 이하 온도• Li-Ion 배터리 : +6°C 이하 온도• 거의 방전된 Li-Ion, NiCd, NiMH 배터리

보관 충전 모드 :

- NiCd & NiMH 배터리 . 배터리에 따라 충전 . 배터리당 약 15 초간 차례로 충전

Li-Ion 배터리에 보관 충전 모드 없음 : 미사용시 전력량 손실이 없기 때문에 이 모드 필요 없음

퀵 충전 모드의 꺼짐 조건 :

NiCd & NiMH 배터리 :

- 타이머
- 용량
- 배터리 온도
- (-) 전압 편차
- 분당 온도 증가
- 이중 변곡 방법

Li-Ion 배터리 :

- 타이머
- 용량
- 배터리 온도
- 충전 정류

NiCd & NiMH 배터리 보관 충전 :

배터리 전압 , 충전 전류 , 배터리 온도 모니터링

- NiCd
- NiMH
- Li-Ion



충전 테크놀러지

셀 종류

충전 및 방전 시간

충전 및 방전 시간은 연결시 전압, 배터리 용량, 충전 상태에 따라 다릅니다.

다음 가이드라인을 참조하십시오 :

20°C 퀵 충전 :

NiCd 배터리

최대 2200 mAh 1.0 ~ 1.5 h

최대 7200 mAh 2.5 ~ 4.0 h

NiMH 배터리

최대 2200 mAh 1.5 ~ 2.0 h

최대 4900 mAh 2.0 ~ 2.5 h

최대 10000 mAh 2.5 ~ 5.5 h

Li-Ion 배터리

최대 4600 mAh 2.5 ~ 3.5 h

방전 :

NiCd & NiMH 배터리

6V 배터리 시간당 600 mAh

12V 배터리 시간당 300 mAh

Li-Ion 배터리

7.4V 배터리

시간당 500 mAh

표시등

"2.6 표시등" 섹션을 참조 하십시오 .

중량

2 X 배터리 아답타 포함 충전기 : 1.12 kg

치수

W X D X H: 최대 237 mm x 227 mm x 43 mm; 배터리 아답터 포함

Total Quality Management: Our commitment to total customer satisfaction.



Leica Geosystems AG, Heerbrugg, Switzerland, has been certified as being equipped with a quality system which meets the International Standards of Quality Management and Quality Systems (ISO standard 9001) and Environmental Management Systems (ISO standard 14001).

Ask your local Leica Geosystems dealer for more information about our TQM program.

Leica Geosystems AG
Heinrich-Wild-Strasse
CH-9435 Heerbrugg
Switzerland
Phone +41 71 727 31 31
www.leica-geosystems.com

- when it has to be **right**

Leica
Geosystems

735006-1.3.0 de/en/fr/es/it/pt/da/no/nl/sv/fi/ja/zh/ko
Printed in Germany
©2012 Leica Geosystems AG, Heerbrugg, Switzerland