

User's Guide

Keysight FieldFox Analyzers

This manual provides documentation for the following models:

N9913A, N99914, N9915A, N9916A, N9917A, N9918A

N9925A, N9926A, N9927A, N9928A

N9935A, N9936A, N9937A, N9938A

N9950A, N9951A, N9952A

N9960A, N9961A, N9962A

Notices

© Keysight Technologies, Inc.
2014-2018

No part of this manual may be reproduced in any form or by any means (including electronic storage and retrieval or translation into a foreign language) without prior agreement and written consent from Keysight Technologies, Inc. as governed by United States and international copyright laws.

Trademark Acknowledgments

Bluetooth®

Manual Part Number

N9927-90001

Edition

Edition 4, May 08, 2018

Printed in USA/Malaysia

Published by:
Keysight Technologies
1400 Fountaingrove Parkway
Santa Rosa, CA 95403

Warranty

THE MATERIAL CONTAINED IN THIS DOCUMENT IS PROVIDED "AS IS," AND IS SUBJECT TO BEING CHANGED, WITHOUT NOTICE, IN FUTURE EDITIONS. FURTHER, TO THE MAXIMUM EXTENT PERMITTED BY APPLICABLE LAW, KEYSIGHT DISCLAIMS ALL WARRANTIES, EITHER EXPRESS OR IMPLIED WITH REGARD TO THIS MANUAL AND ANY INFORMATION CONTAINED HEREIN, INCLUDING BUT NOT LIMITED TO THE IMPLIED WARRANTIES OF MERCHANTABILITY AND FITNESS FOR A PARTICULAR PURPOSE. KEYSIGHT SHALL NOT BE LIABLE FOR ERRORS OR FOR INCIDENTAL OR CONSEQUENTIAL DAMAGES IN CONNECTION WITH THE FURNISHING, USE, OR PERFORMANCE OF THIS DOCUMENT OR ANY INFORMATION CONTAINED HEREIN. SHOULD KEYSIGHT AND THE USER HAVE A SEPARATE WRITTEN AGREEMENT WITH WARRANTY TERMS COVERING THE MATERIAL IN THIS

DOCUMENT THAT CONFLICT WITH THESE TERMS, THE WARRANTY TERMS IN THE SEPARATE AGREEMENT WILL CONTROL.

Technology Licenses

The hardware and/or software described in this document are furnished under a license and may be used or copied only in accordance with the terms of such license.

U.S. Government Rights

The Software is "commercial computer software," as defined by Federal Acquisition Regulation ("FAR") 2.101. Pursuant to FAR 12.212 and 27.405-3 and Department of Defense FAR Supplement ("DFARS") 227.7202, the U.S. government acquires commercial computer software under the same terms by which the software is customarily provided to the public. Accordingly, Keysight provides the Software to U.S. government customers under its standard commercial license, which is embodied in its End User License Agreement (EULA), a copy of which can be found at

<http://www.keysight.com/find/sweula>. The license set forth in the EULA represents the exclusive authority by which the U.S. government may use, modify, distribute, or disclose the Software. The EULA and the license set forth therein, does not require or permit, among other things, that Keysight: (1) Furnish technical information related to commercial computer software or commercial computer software documentation that is not customarily provided to the public; or (2) Relinquish to, or otherwise provide, the government rights in excess of these rights customarily provided to the public to use, modify, reproduce, release, perform, display, or disclose commercial computer software or commercial computer software documentation. No additional government requirements beyond those set forth in the EULA shall apply, except to the extent that those terms, rights, or licenses are explicitly required from all providers of commercial computer software pursuant to the FAR and the DFARS and are set forth specifically in

writing elsewhere in the EULA. Keysight shall be under no obligation to update, revise or otherwise modify the Software. With respect to any technical data as defined by FAR 2.101, pursuant to FAR 12.211 and 27.404.2 and DFARS 227.7102, the U.S. government acquires no greater than Limited Rights as defined in FAR 27.401 or DFAR 227.7103-5 (c), as applicable in any technical data.

Safety Notices

CAUTION

A **CAUTION** notice denotes a hazard. It calls attention to an operating procedure, practice, or the like that, if not correctly performed or adhered to, could result in damage to the product or loss of important data. Do not proceed beyond a CAUTION notice until the indicated conditions are fully understood and met.

WARNING

A **WARNING** notice denotes a hazard. It calls attention to an operating procedure, practice, or the like that, if not correctly performed or adhered to, could result in personal injury or death. Do not proceed beyond a WARNING notice until the indicated conditions are fully understood and met.

Where to Find the Latest Information

Documentation is updated periodically. For the latest information about these products, including instrument software upgrades, application information, and product information, browse to one of the following URLs, according to the name of your product:

<http://www.keysight.com/find/fieldfox>

To receive the latest updates by email, subscribe to Keysight Email Updates at the following URL:

<http://www.keysight.com/find/MyKeysight>

Information on preventing instrument damage can be found at:

www.keysight.com/find/PreventingInstrumentRepair

Is your product software up-to-date?

Periodically, Keysight releases software updates to fix known defects and incorporate product enhancements. To search for software updates for your product, go to the Keysight Technical Support website at:

<http://www.keysight.com/find/fieldfoxsupport>

A.08.18 Firmware Release (CPU1) Updates (N991xA/2xA/3xA with serial number prefixes <5607)

For customers upgrading FieldFox firmware, the following is a list of changes from the previous release:

Other updates:

- N755xA ECal support
- CAT/TDR default changed to "Cable"
- NA/CAT OSL ≥ 4001 points calibrations
- Normalization cal behavior
- Internet time update behavior

A.10.30 Firmware Release (CPU2) Updates (Also, applies to: N991xA/2xA/3xA units with serial number prefixes ≥ 5607 ¹)

For customers upgrading FieldFox firmware, the following is a list of changes from the previous release:

Added Noise Figure Mode:

Chapter 23, "Noise Figure Mode (Option 356 – CPU2 Only)," on page 387

1. Country codes have been omitted from serial number prefixes.

Contacting Keysight

Assistance with test and measurements needs and information on finding a local Keysight office are available on the Web at: <http://www.keysight.com/find/assist>.

If you do not have access to the Internet, please contact your Keysight field engineer.

In any correspondence or telephone conversation, refer to the Keysight product by its model number and full serial number. With this information, the Keysight representative can determine whether your product is still within its warranty period.

Table of Contents

1. Overview	
Models and Options	21
Accessories	22
Optional Accessories	22
FieldFox Manuals, Software, and Supplemental Help	23
Conventions that are used in the Manual	23
Safety Notes	23
2. Preparing for Initial Use of Your New FieldFox	
Check the Shipment	25
Meeting Power Requirements for the AC/DC Adapter	25
Install the Lithium-Ion Battery	26
Battery Usage	26
FieldFox ON/OFF Settings	27
Power Button LED Status	28
FieldFox High Temperature Protection	28
How to monitor the internal FieldFox temperature:	28
Temperature Control Mode	29
High-Temp Shutdown Warning (RTSA Mode Only)	31
Avoid Overpowering the FieldFox	32
Take the FieldFox Tour	33
Front Panel	33
Top Panel	36
Right Side Panel	36
Left Side Panel	38
Screen Tour	39
How to Enter Numeric Values	41
Multiplier Abbreviations	41
Connector Care	42
3. CAT (Cable and Antenna Test) Mode	
CAT Mode Settings	45
How to select CAT Mode	45
Measurement Selection	45
Quick Settings Table	46
Frequency Range	47
Scale Settings	47
Averaging	48

Contents

Smoothing	49
Single or Continuous Measure	49
Resolution (Number of Data Points)	50
Sweep Time	50
Output Power	51
Interference Rejection	51
Coupled Frequency	52
Return Loss Measurements	53
How to Measure Return Loss	53
1-Port Cable Loss Measurements	53
How to make a 1-port Cable Loss Measurement	54
2-Port Insertion Loss Measurements	55
4. DTF (Distance to Fault) Measurements	
How to make DTF Measurements	58
DTF Measurement Settings	60
DTF Settings Table	60
DTF Measurement (Format)	60
DTF Start and Stop Distance	61
Frequency Mode	61
Coupled Frequency	62
Cable (Correction) Specifications	63
Window Settings	66
DTF Units	67
Calculated DTF values	67
About Alias Faults	67
5. TDR (Time Domain Reflectometry) - Option 215	
TDR Measurement Settings	72
TDR Measurement (Format)	72
TDR Settings Table	72
TDR Start and Stop Distance	73
TDR Sweep	73
Frequency Mode	74
Cable (Correction) Specifications	75
Window Settings	78
TDR Units	79
Calculated TDR values	79
About Alias Faults	80
How to Prevent Undersampling	81
6. NA (Network Analyzer) Mode	

NA Mode Settings	85
About S-parameters	85
Mixed-Mode S-Parameters	86
Parameter Conversion	87
Receiver Measurements	88
Multi-Trace Configurations	89
Quick Settings	90
Calibration Settings	91
Format	92
Frequency Range	93
Scale Settings	93
Magnitude Offset	94
Electrical Delay	95
Phase Offset	95
Averaging	96
IF Bandwidth	97
Smoothing	97
Single or Continuous Measure	98
Resolution (Number of Data Points)	98
Sweep Time	99
Triggering	99
Output Power	100
System Impedance (Z0)	101
Port Extensions	101
Velocity Factor	102
Big Marker Display States (A and B)	103
Increase Dynamic Range	105
7. Time Domain – Option 010	
Overview	109
Time Domain (Transform) Settings	110
Transform Settings Table	110
Start/Stop (Frequency Range) and Points	110
Stimulus (Mode)	111
Set Frequency Lowpass	111
Start/Stop Time	111
Distance Units	112
Window Layout	112
Transform Window	112
Line Loss and Velocity Factor	113
Data Chain	114
Trace Settings	115

Contents

Transform Enable	115
Gate Enable	115
Gating	116
How to make Time Domain Gating settings	117
Start, Stop, Center, and Span Gate Times	117
Gating Type	117
8. Calibration for NA, CAT, and VVM Modes	120
Why and When to Calibrate	120
Definitions	120
CalReady	121
How to Perform a Calibration	121
QuickCal (N991xA/2xA/3xA Only)	123
Mechanical Cal	125
ECal	128
Simple Response Cals	130
View Cal	132
Calibration Type	132
Isolation Step	135
Waveguide Calibrations	135
Enhanced Response Optimization	137
Interpolation *	138
Cal ON ? – Questionable Accuracy	138
Compatible Mode Calibrations	138
Save the Calibration	138
CalReady Properties	139
Verifying Calibration and Jumper Cable Integrity	140
Verify a Calibration	140
Test the Jumper Cable	140
Calibration Method Summary	141
9. SA (Spectrum Analyzer) Mode	146
SA Mode Settings	146
How to select SA Mode	146
Frequency Range	146
Radio Standard	148
Custom Radio Standards	148
Channel Selection	149
Reverse Swap	151
Scale and Units	151
External Gain	152

Attenuation Control	152
Preamplifier Control (Opt 235)	153
Check for Compressed Measurements	153
Field Strength Measurements	154
Using the Antenna/Cable Editor	156
Source Tracking Offset and Offset Reversal	158
Tune & Listen (AM/FM)	159
Independent Source/Tracking Generator	161
Resolution Bandwidth (Res BW)	163
Video Bandwidth (Video BW)	164
Sweep Type	164
IF Output	165
Sweep Acquisition	166
Very Long Sweep Times	167
Zero Span Measurements	167
Triggering	169
FFT Gating (Opt 238)	172
Single / Continuous / Restart	174
Points	174
Trace Display States (SA Mode)	175
Average Type	176
Average Count	176
Alignments	177
Detection Method	184
Display Line	186
Noise Marker	187
Band/Interval Power Marker	187
Frequency Counter at Marker	188
Time Zero Fixed Marker	189
Audio Beep at Marker Power	189
Meas UNCAL Error	190
Old Data Indicator (*)	190
Channel Measurements	191
Radio Standards and Channel Measurements	191
Measurement Preset	191
Averaging	191
Traces	192
Channel Power (CHP)	192
10. RTSA (Real-Time Spectrum Analyzer) Mode—Option 350 (CPU2 Only)	
RTSA Mode Settings	205
How to select RTSA Mode	205

Contents

Frequency Range	205
Scale and Units	206
External Gain	207
Attenuation Control	207
Preamplifier Control (Opt 235)	208
Check for Compressed Measurements	209
Spectrum Selection	209
Resolution Bandwidth (Res BW)	212
Triggering	213
Single / Continuous / Restart / Time Per Div	216
Acq Time	217
Points (not user settable)	217
Trace Display States	218
Detection Method	219
Average Count, Show Density, Blue, and Red Percentage Limits	220
Alignments	221
Display Line	221
Spectrogram Display	223
Spectrogram Display (RTSA Option)	223
Common Settings for Spectrogram	224
Record/Playback (RTSA Option)	225
About Sessions	225
FieldFox Setting Changes during Record and Playback	226
About State and User Tags	227
How to Record a Session	228
How to Playback a Session	229
Recording Configuration	230
Record Source	231
Playback Configuration	232
Manage Sessions	232
Record Playback Example (RTSA Mode Only)	233
11. IQ Analyzer (IQA) – Option 351 (CPU2 Only)	
About I/Q Analyzer (IQA) Measurements	238
I/Q Analyzer (IQA) Mode Settings	239
How to Make Measurements Using the I/Q Analyzer Mode	239
How to Capture I/Q Data to a File	240
How to modify the I/Q data measurement parameters	243
Using Markers (IQA)	254
Noise Marker	254
Band/Interval Power Marker	255

Band Span Marker (Spectrum Only)	256
Interval Span Marker (Waveform Only)	256
Coupled Markers (Waveform Only)	256
Continuous Peak Search Marker	258
Alignments	259
Trace Display States (IQA Mode)	259
How to display the Trace States	259
Other Features Available	261
12. Remote Server Mode (Requires CPU2 and SA Hardware/SA Option 233)	
In this Chapter:	264
Connecting Using Remote Server	265
89600 VSA Software Overview (Requires CPU2 and N991xA/3x/A5x/A6xA and SA Option 233)	267
13. Interference Analyzer (SA Mode) – Option 236	
Spectrogram and Waterfall Displays	270
Spectrogram Display (SA Option)	270
Common Settings for Waterfall and Spectrogram	272
Waterfall Display	273
Record/Playback (SA Option).	275
About Sessions.	275
FieldFox Setting Changes during Record and Playback	276
About State and User Tags	277
How to Record a Session	278
How to Playback a Session	279
Recording Configuration	279
Frequency Mask Trigger Configuration (SA Mode Only)	281
Record Source	282
Playback Configuration	283
Manage Sessions	283
Record Playback Example (SA Only)	284
14. Reflection Mode (SA Models) - Option 320	
Reflection Mode Settings	290
How to select Reflection Mode	290
Measurement Selection	290
Normalize	290
15. Built-in Power Meter Mode – Option 310	
Built-in Power Meter Settings	295

Contents

How to select Built-in Power Meter Mode	295
Frequency/ Span / Step	295
Attenuation	296
16. Power Meter (USB) Mode - Option 302	299
Supported Power Sensors	299
How to Connect the Power Sensor	299
USB Power Meter Settings	301
How to select Power Meter Mode	301
Average / Peak	301
Zeroing	301
Frequency	302
Source Control	302
Relative and Offset Power Measurements	304
Display Units	304
Resolution	304
Averaging	305
Single or Continuous Measure	305
Step Detection Mode	306
Limits	306
17. Frequency Offset Using Power Sensor (FOPS) – Option 208	309
Overview	309
FOPS Settings	311
How to select Power Meter (USB Sensor)	311
Measurement Selection	311
Sweep Type and Frequency	312
Power Sensor Settling	314
Sweep Settings	314
Amplitude Markers	315
Trace Math	315
18. Pulse Measurements Mode – Option 330	319
Supported Power Sensors	319
Switching between Pulse Measurement Mode and Power Meter Mode	319
How to Connect the Power Sensor	319
Pulse Measurement Settings	320
How to select Pulse Measurement Mode	320
Measurement Selection	320
Frequency / Time	320
Zoom Window	321

Scale	322
Averaging	322
Video Bandwidth	323
Single or Continuous Measure	323
Resolution	324
Triggering	324
Marker Settings	327
Amplitude Markers	328
Marker Search	328
Auto Analysis	329
Pulse Top	330
Grid	330
Trace Memory	330
19. VVM (Vector Voltmeter) Mode - Option 308	
Overview	335
VVM Mode Settings	336
How to select VVM Mode	336
Measurement Selection	336
Frequency Selection	336
Display Resolution	336
IF Bandwidth	337
Output Power	337
Averaging	338
Single or Continuous Measure	339
VVM Calibration	339
Zeroing	339
1-Port Cable Trimming Measurements	341
How to make a 1-Port Cable Trimming Measurement	341
2-Port Transmission Measurements	343
How to make a 2-Port Transmission Measurement	343
A/B and B/A Measurements	345
20. ERTA (Extended Range Transmission Analysis) Mode - Option 209	
Overview	348
Requirements and Limitations	349
Requirements	349
Limitations	349
Start Connection Wizard	350
On the Receiver unit:	350
Configure Measurement Settings	354

Contents

Select Measurement	354
Normalize.	355
Source Tracking Offset and Offset Reversal	355
Improve Dynamic Range	356
Source Enable and Source Mode	356
21. AM/FM Metrics (SA Only and Option 355)	
Using AM/FM Metrics	357
Overview of Measurement Types.	357
How to Set Up AM/FM Metrics.	360
SINAD and THD Calculations	364
Interpreting AM/FM Metrics Error Messages	367
Test Tone Not Found	367
22. Channel Scanner (Option 312)	
Using Channel Scanner	371
How to Set Up Channel Scanner	372
How to Define a Channel and Use Channel Scanner.	374
23. Noise Figure Mode (Option 356 – CPU2 Only)	
Using Noise Figure.	390
How to Define a Noise Figure Measurement	394
Example: Typical Noise Figure Measurement Procedure	394
Overview of Softkey Menus.	395
How to Use DUT Measurement Setups	402
Single / Continuous / Restart.	414
Points	414
Resolution Bandwidth (Res BW).	415
Alignments	415
Calculating Noise Figure Measurement Uncertainty	416
Using ENR Tables	421
About ENR (*.enr), Preamplifier (*.amp), and DUT (*.dut) Files	422
Using Markers (Noise Figure)	424
Calibration Wizard	425
When to Calibrate	425
How to use Auto-Integration.	428
About Auto-Integration	428
Auto-Integration Procedure	429
Other Features Available	434
Troubleshooting	435

24. Data Analysis Features

All about Markers	438
How to create Markers	438
How to move a Marker after it is created.	438
About Delta Markers	439
Signal Track Marker (NF and SA Mode ONLY)	440
Marker Table	440
Coupled Markers (NA Mode)	441
Marker Colors	442
Marker Trace (CAT, NA, NF Modes)	442
Marker Trace (IQA and SA Mode).	442
Marker Format	443
Searching with Markers	444
What Is a 'Peak'	449
Marker Functions	451
I/Q Analyzer (IQA) Marker Functions	452
SA Marker Functions	452
All about Limit Lines	453
How to Create Fixed Limit Lines	453
Relative Limit Lines	454
Build From Trace.	454
Limit Options	455
How to Save and Recall Limits	456
Display Line (I/Q, NF, and SA Modes Only).	457
All about Trace Math	458
How to display data and memory traces.	458
How to perform Trace Math	458
About Math Operations	459
All about Scale Settings	460
How to Use Scale Settings.	460
Averaging (CAT, NA, Power Meter, Channel Scanner, and Pulse Measurement Modes Only)	460

25. System Settings

Run/Hold	464
How to perform a single sweep while in Hold.	464
Preset	465
How to Preset the FieldFox	465
User Preset	465
How to set User Preset	465
How to recall User Preset	466

Contents

Audio (Volume) Control	466
How to set the FieldFox Volume Control	466
Display (Settings).	467
Display Brightness.	467
Display Colors	467
Trace Width	468
Title	468
Edit Keywords	469
Full Screen Mode.	469
Preferences	469
Quick Settings Table	469
Save and Reset Preferences	470
Global Settings (Overview)	471
Display	473
Audio	474
Date and Time	475
GPS	475
How to select CAT distance units:.	475
File folders	476
How to set File Folders	476
Alpha Numeric Editing.	477
File Saving Naming Options	477
CAT (Distance Units)	477
CAT/NA	478
SA.	479
System Configuration	479
Options (Licensing)	479
GPS	480
Frequency Reference Source	484
Variable Voltage Source (Opt. 309).	485
Security Level	486
Date and Time, Format, and Time Zone Settings.	487
LAN Settings	488
Power ON.	490
FieldFox Package Installer (N995xA, N996xA, and applies to: N991xA/2xA/3xA units with serial number prefixes \geq 5607).	491
Service Diagnostics	493
System Information	493

26. Using the Mini-USB Port to send SCPI Commands and Queries (N995xA/6xA and applies to: N991xA/2xA/3xA units with serial number prefixes \geq 5607)

Mini-USB Connection to PC with IO Libraries	495
27. File Management	
Saving and Recalling Files	498
Save Files	498
Recall Files	502
Move (Copy) Files	502
Set File Type and Select Device	503
Manage Files	506
Manage Folders	508
Edit Keywords	509
Prefixes and Suffixes for Filenames	509
Press Printing	512
How to print the current screen or a saved file	512
28. Working with the Lithium-Ion Battery	
Viewing the Battery Charge Status	513
Service Diagnostics—Battery Screen	514
Built-In Battery Gauge	514
Charging the Battery	515
Internal Charging with the AC/DC Adapter	515
Using the External Battery Charger (N9910X-872)	517
Reconditioning Battery	518
Battery Care	518
Maximizing Battery Life	518
Lithium-Ion Battery Disposal	519
29. Safety Considerations	
For the FieldFox	522
For the AC/DC Adapter	524
For the External Battery Charger (N9910X-872)	525
For the Battery	525
Battery Protective Functions	526
Active Protection	527
Passive Protection	528
Batteries: Safe Handling and Disposal	528
Environmental Requirements	528
Electrical Requirements	528
Electrostatic Discharge (ESD) Precautions	529
FieldFox Markings	530

Contents

Battery Markings	531
Packaging Markings	533
AC/DC Adapter Markings	533
Certification and Compliance Statements	534
Certification	534
Manufacturer's Declaration	534
Declaration of Conformity	534
EMC	535
Safety	535
South Korean Class B EMC Declaration	535
Acoustic Statement (European Machinery Directive)	535
A: Connector Care Review	539
B: Specifications/Data Sheet	542
C: Instrument Calibration	
How Often Should Calibrate My Instrument?	543
How do I Get an Instrument Calibration?	543
What Are My Choices of Instrument Calibration?	544
D: Korean Battery Safety Translation	545
E: Keysight Software End-User Licensing Agreement (EULA)	548

1 Overview

Models and Options

Table 1-1 Models

Model	Max Freq (GHz)	Description
N9913A	4	Vector Network Analyzer AND Spectrum Analyzer
N9914A	6.5	Vector Network Analyzer AND Spectrum Analyzer
N9915A	9	Vector Network Analyzer AND Spectrum Analyzer
N9916A	14	Vector Network Analyzer AND Spectrum Analyzer
N9917A	18	Vector Network Analyzer AND Spectrum Analyzer
N9918A	26.5	Vector Network Analyzer AND Spectrum Analyzer
N9925A	9	Vector Network Analyzer
N9926A	14	Vector Network Analyzer
N9927A	18	Vector Network Analyzer
N9928A	26.5	Vector Network Analyzer
N9935A	9	Spectrum Analyzer
N9936A	14	Spectrum Analyzer
N9937A	18	Spectrum Analyzer
N9938A	26.5	Spectrum Analyzer
N9950A	32	Vector Network Analyzer AND Spectrum Analyzer
N9951A	44	Vector Network Analyzer AND Spectrum Analyzer
N9952A	50	Vector Network Analyzer AND Spectrum Analyzer
N9960A	32	Spectrum Analyzer
N9961A	44	Spectrum Analyzer
N9962A	50	Spectrum Analyzer

Minimum Frequency: 30 kHz for all models

FieldFox Options: For a comprehensive list, view the FieldFox Configuration Guide at: <http://literature.cdn.keysight.com/litweb/pdf/5990-9836EN.pdf>

Accessories

The following accessories are included with every FieldFox. Spare accessories can be ordered at any time. Refer to **Table 1-2**. Some of the optional accessories—not included unless requested—are listed in **Table 1-3**. For more, refer to <http://www.keysight.com/find/fieldfox>.

Table 1-2 Accessories

Accessory Part Number	Description
N9910X-873	AC/DC Adapter (except for US/Canada) ^a
N9910X-870	Lithium-Ion Battery
N9910X-877	AC/DC Adapter for US / Canada only ^a
N9910X-880	Soft-case w/ Backpack & Shoulder Strap
N9910X-890	User's Guide (printed copy)
N9910X-891	Quick Reference Guide (printed copy)

a. Depending on your region, the FieldFox comes with either a N9910X-873 AC/DC adapter or a N9910X-877 AC/DC adapter.

Optional Accessories

Table 1-3 Optional Accessories (partial list)

Optional Accessory Part Number	Description
N9910X-872	External battery charger
N9910X-876	17 mm torque wrench

NOTE

Although not supplied, a USB keyboard and mouse CAN be used with the FieldFox.

To see a complete list of accessories that are available for the FieldFox, please visit: <http://www.keysight.com/find/fieldfox>.

FieldFox Manuals, Software, and Supplemental Help

The following manuals and software are available for the FieldFox.

To access all of these, visit: www.keysight.com/find/fieldfoxsupport

- **User’s Guide** – This manual, included with shipment.
- **Quick Reference Guide** – Printed copy with laminated pages for outdoor use included with shipment.
- **Supplemental Online Help** – Concepts and Reference information.
Programming Guide – Online, off line and pdf versions.
<http://na.support.keysight.com/fieldfox/help/SupHelp/FieldFox.htm>
- **FieldFox Data Link Software and Help** – Free download. Includes help on editing calibration kits and cable files. Refer to
<http://www.keysight.com/main/software>.
- **Service Guide** – Free download.
- **Firmware Updates** – Check to see if you have the latest FieldFox firmware.

Conventions that are used in the Manual

- **Hardkey** indicates a front panel button. The functionality of these buttons does not change.

The six Softkey menus change dynamically and follow these color conventions:

- **Softkey** Blue indicates an available setting.
- **Softkey** Green indicates a change in menu level when selected.
- **Softkey** Black indicates the default or selected setting.
- **Softkey** Yellow indicates an active entry in process.
- **Softkey** Grey indicates a key that is NOT available.

Safety Notes

The following safety notes are used throughout this manual. Familiarize yourself with each of the notes and its meaning before operating this instrument. More pertinent safety notes for using this product are located in **Chapter 29, “Safety Considerations”, on page 521.**

CAUTION

Denotes a hazard. It calls attention to a procedure that, if not correctly performed or adhered to, would result in damage to or destruction of the product. Do not proceed beyond a caution note until the indicated conditions are fully understood and met.

WARNING

Denotes a hazard. It calls attention to a procedure which, if not correctly performed or adhered to, could result in injury or loss of life. Do not proceed beyond a warning note until the indicated conditions are fully understood and met.

2 Preparing for Initial Use of Your New FieldFox

Check the Shipment

When you receive your FieldFox, check the shipment according to the following procedure:

1. Inspect the shipping container for damage. Signs of damage may include a dented or torn shipping container or cushioning material that indicates signs of unusual stress or compacting. If not damaged, save the packaging material in case the FieldFox needs to be returned
2. Carefully remove the contents from the shipping container, and verify that the standard accessories and your ordered options are included in the shipment according to the Box Contents List
3. For any question or problems, refer to **“Contacting Keysight” on page 5**

Meeting Power Requirements for the AC/DC Adapter

Voltage:	100 VAC to 250 VAC
Frequency:	50 Hz to 60 Hz
Current:	1.25 A (100 VAC) to 0.56 A (250 VAC)

The AC/DC adapter supplied with the analyzer is equipped with a three-wire power cord, in accordance with international safety standards. The power cable appropriate to the original product shipping location is included with the FieldFox.

Various AC power cables are available from Keysight that are unique to specific geographic areas. You can order additional AC power cables that are correct for use in different areas. For the power cord part number information please visit: <http://www.keysight.com/find/fieldfox>

Install the Lithium-Ion Battery



- | | |
|----------------------------|---|
| 1. Open the battery door | Push the button on the battery compartment door while sliding the door outward. |
| 2. Insert the battery. | The terminals end of the battery is inserted into the compartment. |
| 3. Close the battery door. | Slide the battery compartment door upwards until it latches. |

Battery Usage

When you receive your FieldFox, the lithium-ion battery is not installed, and it is partially charged to approximately 40% to preserve battery life. A lithium-ion battery has no memory effect, so it can be used partially charged, as shipped.

A fully charged battery will power your FieldFox for about four hours, so if you plan to use it for this long, you should fully charge the battery.

NOTE

The FieldFox will shut down to prevent the battery from discharging to a level that is damaging. If this occurs, charge the battery either internally or externally.

Learn more about the lithium-ion battery in [Chapter 28, “Working with the Lithium-Ion Battery.”](#)

Battery charge status is viewable:

-  In the upper-right corner of the screen.
- On the Battery screen. To access the screen, select **System**, **Service**, **Diagnostics**, and **Battery**.

- On the battery. Open the FieldFox battery compartment door to view the battery LCD.

To conserve battery power:

- Use **Run/Hold** to single-trigger a measurement when needed. **Hold** is shown on the display.
- Press **System** then **Display** then **Brightness**. Use the **▲▼** arrows, the rotary knob, or numeric keypad to adjust the brightness to dim the FieldFox display as much as possible.
- Briefly press the power button > Standby, to switch to Standby mode when the FieldFox is not being used. Press power button again to restore power. All current settings are preserved.

NOTE

When powered by the battery only, the FieldFox can stay in Standby mode for a maximum of four hours and then it powers off automatically. When the relative battery charge drops by about 20%, the FieldFox will power off to preserve the remaining charge.

To recharge a battery:

Use ONLY a FieldFox charger to recharge a battery.

- The battery can be fully charged while in the FieldFox in about 4 hours with the FieldFox either ON or OFF.
- The battery can be fully charged externally using the external battery charger in about 4 hours.
- When the battery is removed, the FieldFox can still be powered by the AC/DC adapter.

FieldFox ON/OFF Settings

NOTE

The FieldFox power button shut down/standby sequence includes a 10 second counter that allows you to either choose a softkey to immediately initiate the action (**Standby**/**Shut down**/**Restart***), or to let the countdown counter expire after 10 seconds then perform the action. *Restart can only be enabled via the Restart softkey.

- To turn power **ON**, briefly press the power button. Boot-up takes about 1 minute.
- To switch to **Standby** mode (low battery drain), briefly press the power button. See the Note above concerning Stand By.

- To turn Power **OFF** (very low battery drain), press the power button briefly and press the Shutdown softkey. Data and instrument state are NOT automatically saved when the FieldFox is powered OFF. Learn how to save data and instrument state in **Chapter 27, “File Management”, on page 497**. See the Note above concerning Shut down.
- To restart FieldFox, press the power button and press **Restart**. See the **Note** above concerning Restart.
- Press **Cancel** to exit the power down sequence.
- You can also access the power down softkey menu choices (**Standby**, **Shut down**, **Restart**, and **Cancel**) by using the **Mode** hardkey:
- Press **Mode**
 - Then **More**
 - Then **Shut down**
- You can make a setting to automatically **Power ON** the FieldFox when a power source is connected. Learn how on **“Power ON” on page 490**.

Power Button LED Status

Solid green	Power is ON
Blinking green	FieldFox in Stand By mode
Blinking amber ^a	Battery charging when the FieldFox power is off
Blinking amber and green	Stand By mode and battery charging
Not lit	Power is Off and battery is not charging

a. LED showing a repeating ramping-up of the intensity of the LED to indicate the battery is charging.

FieldFox High Temperature Protection

The following features prevent degradation or damage in the event of high internal temperatures in the FieldFox.

NOTE

Do NOT store the FieldFox in the soft-case while powered ON or in Standby mode.

How to monitor the internal FieldFox temperature:

- Press **System**, then **Service Diagnostics**.
- Then **Internal Temperatures**.

- The temperature at which the following events occur is the **average** of the RF1, RF2, SB1, SB2 temperatures. These temperatures come from internal sensors embedded within FieldFox.

Temperature Control Mode

The FieldFox's internal temperature control preserves measurement accuracy and maintains the long-term reliability of the FieldFox. See also, "**High-Temp Shutdown Warning (RTSA Mode Only)**" on page 31.

NOTE

Measurement speed specifications do NOT apply in Temperature Control Mode.

Entering Temperature Control Mode

At an average internal temperature of above approximately 64°C, the FieldFox enters Temperature Control mode by reducing display intensity. This should decrease the internal temperature which preserves measurement accuracy and maintains the long-term reliability of the FieldFox. Refer to **Figure 2-1**.

In addition, duty cycling is enabled when the internal average temperature of the FieldFox reaches the duty cycling threshold of above ~64°C. All applications (except RTSA): Power for internal circuitry is turned off between sweeps and delaying occurs for the next sweep. In RTSA mode, power is only turned off, if the FieldFox is in Single Sweep or Hold.

All applications (including RTSA): Display dims to 40% at ~64°C.

For all modes, except RTSA mode, you will see the following messages displayed for ~3 seconds:

```
"Automatic Meas Duty Cycling activated for thermal management"
```

Later if the temperatures are reduced:

```
"Temperatures reduced, ending Automatic Meas Duty Cycling"
```

For RTSA mode (where duty cycling is not possible), you will see the following messages displayed for ~3 seconds:

```
"Entering Auto Protect mode for thermal management"
```

Later if the temperatures are reduced:

```
"Temperatures reduced, exiting Automatic Protect Mode"
```

Entering Auto Protect (Maximum) Threshold Temperature Mode

At above approximately 75°C, the FieldFox enters (Maximum) Auto Protect temperature control mode by displaying the "Entering Auto Protect mode...". See also **Table 2-1 on page 32**.

When you enter the Auto Protect (Maximum) Threshold, the following message is displayed:

"Entering Maximum Auto Protect mode for thermal management"

When temperature reaches the maximum protection threshold (~75°C), some applications take additional measures.

Figure 2-1 Entering Auto Protect mode message (above ~64°C)—(Displays for 3 sec)



Exiting Maximum Auto Protect Threshold Temperature Mode

When the temperature drops to approximately 73.5°C, a message is displayed indicating that the FieldFox is leaving Temperature Control Mode and normal operating settings are restored (refer to [Figure 2-2](#)). See also, [Table 2-1 on page 32](#).

When you exit the Auto Protect (Maximum) Threshold control mode, the following message is displayed:

"Temperatures reduced, exiting Maximum Auto Protect mode"

Figure 2-2 Exiting Maximum Auto Protect mode message—(~62.5°C)

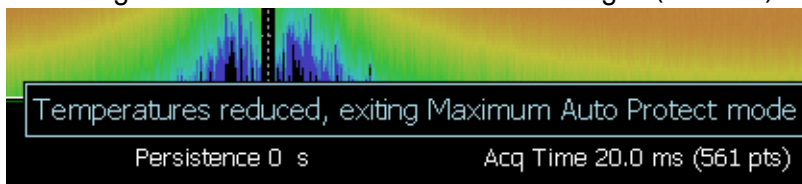

High-Temp Shutdown Warning (RTSA Mode Only)

In extreme situations, Temperature Control mode may not stop an increase in the FieldFox internal temperature. Just prior to shut down, the FieldFox will display a warning of imminent shut down and the instrument turns off. At above approximately 77°C, a Maximum Auto Protect message—(Top "WARNING..." message) displays for 9 sec. Red text at left bottom corner of display remains on until internal temperature returns to ~75.5°C. At above ~78°C, High-Temperature Shut down will engage and turn OFF the FieldFox. Refer to [Figure 2-3](#). See also, [Table 2-1 on page 32](#).

Figure 2-3 Shutdown Warning message—(above ~77°C) - (RTSA Mode Only!)

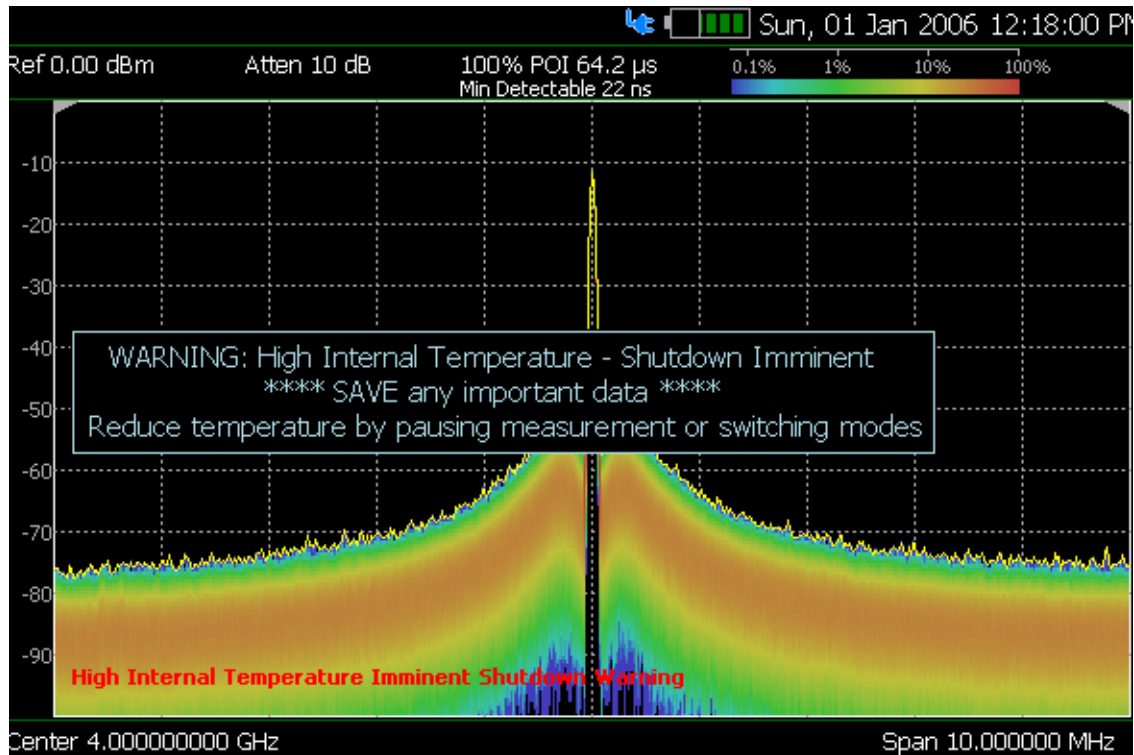

Summary of FieldFox Average Internal Temperature Protection Behavior

Table 2-1 Summary of FieldFox Temperature Protection

Threshold	Average Internal Temperature	Description of Behavior
Duty cycling	~64°C	Duty cycling is enabled when the internal average temperature of the FieldFox reaches the duty cycling threshold of ~64°C. Power is turned off between sweeps and delaying occurs for the next sweep. In RTSA mode power is only turned off in Single Sweep or Hold. This enables you to control your instrument's temperature when you don't need to make a measurement by using the "Run/Hold" hardkey to pause the sweep. All applications (including RTSA): Display dims to 40% at ~64°C.
Maximum Protect (Initial)	~75°C	When temperature reaches the maximum protection threshold (~75°C) some applications take additional measures.
1 degree below shutdown (RTSA Mode Only)	~77°C	RTSA Shutdown Warning (~77°C) – (Top "WARNING..." message displays for 9 sec). Red text at bottom of display remains on until internal temperature returns to ~75.5°C. Refer to Figure 2-3 on page 31 .
Shutdown	~78°C	Instrument shuts down.
Exit Duty Cycle	~62.5°C	The temperature required to come out of the duty cycle threshold.

Avoid Overpowering the FieldFox

The FieldFox can be damaged with too much power or voltage applied. Exceeding the maximum RF power levels shown below will cause an ADC Over Range message to appear on the screen.

CAUTION

Maximum Input Voltages and Power:

- RF IN/OUT Connectors: ±50 VDC, +27 dBm RF
- DC Input: -19 to 19 VDC, 60 Watts maximum when charging battery

Learn more about Maximum power and voltages in the FieldFox Data Sheet.

NOTE

Very often, coaxial cables and antennas build up a static charge, which, if allowed to discharge by connecting to the FieldFox, may damage the instrument input circuitry. To avoid such damage, it is recommended to dissipate any static charges by temporarily attaching a short to the cable or antenna prior to attaching to the FieldFox.

Take the FieldFox Tour

Front Panel



N9912_001_401

Preparing for Initial Use of Your New FieldFox
Take the FieldFox Tour

No.	Caption	Description	Learn More:
1	Power	ON: press momentarily. STAND BY: with FieldFox power ON, press briefly. OFF: press and hold until the FieldFox shuts off (about 4 seconds).	“FieldFox ON/OFF Settings” on page 27
2	LED	Not lit: FieldFox OFF, not charging Green: FieldFox ON. Charging status indicated by battery icon on screen Orange, flashing: FieldFox STAND BY Orange, intensity increasing, flashing slowly: FieldFox OFF, charging	“Power Button LED Status” on page 28
3	System	Displays a sub-menu for system setup	“System Settings” on page 463
4	Function keys	Includes: Freq/Dist , Scale/Amptd , BW , Sweep , Trace , Meas Setup , Measure , and Mode .	Refer to specific Mode.
5	Preset	Returns the analyzer to a known state	“How to Preset the FieldFox” on page 465
6	Enter	Confirms a parameter selection or configuration	--
7	Marker	Activates marker function	“All about Markers” on page 438
8	Mkr-->Tools	Displays a sub-menu for marker functions	“All about Markers” on page 438
9	Esc	Exits and closes the Active Entry dialog box or clears the character input	--
10	Save/Recall	Saves the current trace or recalls saved data from memory	“Saving and Recalling Files” on page 498

Preparing for Initial Use of Your New FieldFox
Take the FieldFox Tour

No.	Caption	Description	Learn More:
11	Limit	Sets limit lines for quick Pass/Fail judgment	“All about Limit Lines” on page 453
12	Run/Hold	Toggles between free Run and Hold/Single operation.	“Run/Hold” on page 464
13	Cal	Displays a sub-menu for calibration functions	“Calibration Method Summary” on page 141
14	Arrow keys	Increases or decreases a value or setting.	--
15	◀Back	Returns to the previous menu selection.	--
16	Rotary knob	Highlights an item for selection, or enables incremental changes to values.	--
17	Softkeys	Allows selection of settings for configuring and performing measurements, and for other FieldFox functions.	--
18	Screen	Transflective screen, viewable under all lighting conditions. If you are using your FieldFox in direct sunlight, you do not need to shield the display from the sunlight. In bright lighting conditions, the display is brighter and easier to read when you allow light to fall directly on the screen. Alternative color modes exist that maximize viewing in direct sunlight conditions, as well as other conditions such as nighttime work.	“Screen Tour” on page 39

NOTE

Clean the Transflective screen with gentle and minimal wiping using Isopropyl alcohol applied to a lint-free cloth.

Top Panel







Caption	Descriptions	Learn More:
Port 1 RF Output	For CAT and NA measurements, use to make reflection measurements. Maximum: ± 50 VDC, +27 dBm RF Also, for SA source output in SA mode.	“CAT Mode Settings” on page 45 “NA Mode Settings” on page 85 Chapter 9, “SA (Spectrum Analyzer) Mode”, on page 143
Port 2 SA RF Input	For SA, use to make all measurements. For CAT, NA, and VVM mode, use to make Port 2 transmission measurements. Maximum: ± 50 VDC, +27 dBm RF.	“SA Mode Settings” on page 146
GPS Ant	SMA (f) connector for use with built-in GPS. Produces a 3.3 VDC bias voltage for the antenna pre-amplifier. Use with a GPS antenna such as N9910X-825. Other GPS antennas can also be used.	“GPS” on page 475
Ref In Trig In	SMA (f) connector for use with Frequency Reference Source and External Trigger Input signal. Maximum: 5.5 VDC.	“Frequency Reference Source” on page 484. “Triggering” on page 169

Right Side Panel



Connector	Description	Learn More:
	Ethernet cable connector to read trace data using the FieldFox Data Link Software and connect to the FieldFox remotely. Download the latest version of the software at: www.keysight.com/find/fieldfoxsupport	“LAN Settings” on page 488



Preparing for Initial Use of Your New FieldFox
Take the FieldFox Tour

Connector	Description	Learn More:
	<p>IF Out used in SA mode for external signal processing.</p>	<p>“IF Output” on page 165</p>
	<p>Frequency Reference Source Output Trigger Output (ERTA mode).</p>	<p>Chapter 20, “ERTA (Extended Range Transmission Analysis) Mode - Option 209”, on page 347</p>
	<p>Secure Digital slot. Use to extend the memory of the FieldFox.</p>	<p>“Saving and Recalling Files” on page 498</p>
	<p>On the N995xA/6xA (Also, applies to: N991xA/2xA/3xA units with serial number prefixes ≥ 5607) models, the mini-USB port can be connected to your PC's standard USB port to send SCPI commands.</p> <p>NOTE</p> <p>IMPORTANT! It is recommended that only USB certified cables are used with the FieldFox.</p>	<p>Chapter 26, “Using the Mini-USB Port to send SCPI Commands and Queries (N995xA/6xA and applies to: N991xA/2xA/3xA units with serial number prefixes ≥ 5607)”, on page 495</p>
	<p>Two standard USB connectors used to connect a power sensor for Power Meter Mode. Also used to save files to a USB flash drive.</p> <p>NOTE</p> <p>IMPORTANT! It is recommended that only USB certified cables are used with the FieldFox.</p>	<p>“Saving and Recalling Files” on page 498</p>

Preparing for Initial Use of Your New FieldFox
Take the FieldFox Tour

Left Side Panel



Connector	Description	Learn More:
	Audio output jack for use with SA Mode Tune and Listen.	“Tune & Listen (AM/FM)” on page 159
	DC Voltage Source for use with external DC Bias.	“Variable Voltage Source (Opt. 309)” on page 485
	DC power connector used to connect to the AC/DC adapter. Maximum: 19 VDC, 4 ADC.	“Internal Charging with the AC/DC Adapter” on page 515

Screen Tour

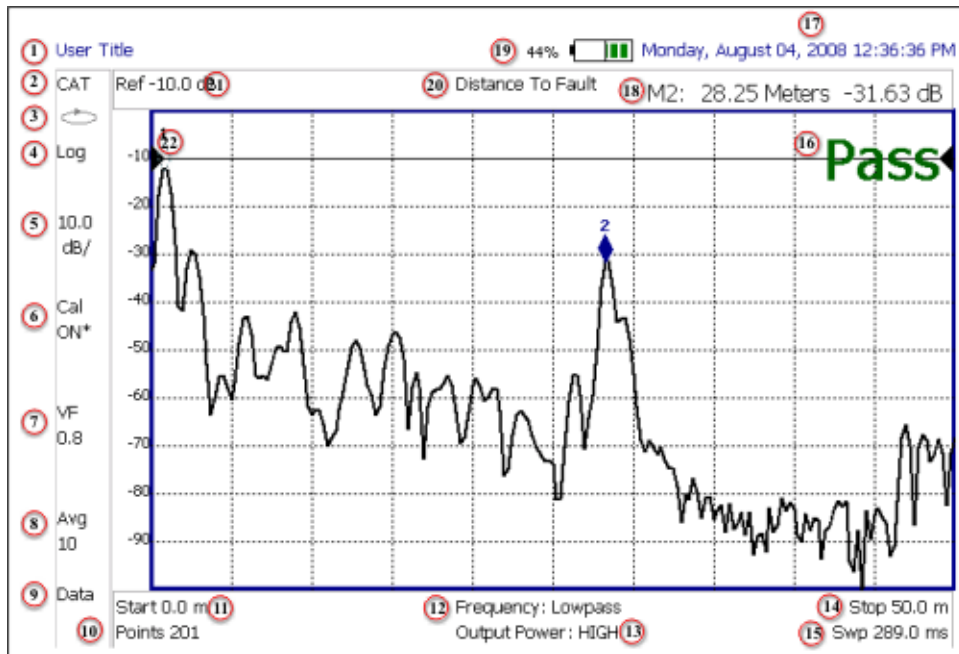

Caption	Description	Learn More:
1	Title – write your own text here	“Title” on page 468
2	Current Mode	--
3	Run / Hold	“Run/Hold” on page 464
4	Display Format	Mode dependent
5	Scale/division	Mode dependent
6	Calibration Status (CAT and NA) Detection Method (SA)	“Cal ON ? – Questionable Accuracy” on page 138
7	Velocity Factor (Fault Meas)	“About Velocity Factor and Cable Loss” on page 63
8	Averaging Status and Count	Mode dependent
9	Data / Mem Display (CAT and NA) Step / FFT (SA)	“All about Trace Math” on page 458 “Resolution Bandwidth (Res BW)” on page 163
10	Resolution Setting	Mode dependent
11	Measurement Start Freq or Distance	Mode dependent

Preparing for Initial Use of Your New FieldFox
Take the FieldFox Tour

Caption	Description	Learn More:
12	Bandpass / Lowpass setting (Fault Meas) IF BW in NA Mode	“DTF Measurement Settings” on page 60
13	Output Power Level (CAT and NA)	“Output Power” on page 51
14	Measurement Stop Freq or Distance	Mode dependent
15	Actual Sweep Time	Mode dependent
16	Limit Line Status	“All about Limit Lines” on page 453
17	Time and Date	“Date and Time” on page 475
18	Marker Readout	“All about Markers” on page 438
19	Battery Status	“Viewing the Battery Charge Status” on page 513
20	Measurement Type (CAT and NA)	--
21	acquisition	Mode dependent
22	Reference Position	Mode dependent

How to Enter Numeric Values

Many settings on the FieldFox require the entry of numeric values.

How to enter numeric values

Use any combination of the following keys:

- Numeric 0–9 keys, along with the polarity (+/-) key.
- Up/Down arrow keys to increment or decrement values.
- Rotary knob to scroll through a set of values.
- **Back** erases previously entered values.
- **Esc** exits data entry without accepting the new value.

To complete the setting, press **Enter** or a different **softkey** or **hardkey**.

Multiplier Abbreviations

Many times after entering numeric values, a set of multiplier or suffix softkeys are presented. The following explains the meaning of these abbreviations.

Select Frequency multipliers as follows:

- **GHz** Gigahertz (1e9 Hertz)
- **MHz** Megahertz (1e6 Hertz)
- **KHz** Kilohertz (1e3 Hertz)
- **Hz** Hertz

Select Time multipliers as follows:

- **s** Seconds
- **ms** milliseconds (1e-3)
- **us** microseconds (1e-6)
- **ns** nanoseconds (1e-9)
- **ps** picoseconds (1e-12)

Connector Care

- Never store connectors, airlines, or calibration standards loose in a box. This is a common cause of connector damage.
- Install protective end caps when connectors are not in use.
- Keep connector temperature the same as the test instrument. Holding the connector in your hand or cleaning connector with compressed air can significantly change the temperature. Wait for connector temperature to stabilize before using in calibration or measurements.
- Do not touch the mating plane surfaces. Natural skin oils and microscopic particles of dirt are difficult to remove from these surfaces.
- Do not set connectors contact-end down on a hard surface. The plating and mating plane surfaces can be damaged if the interface comes in contact with any hard surface.
- Wear a grounded wrist strap and work on a grounded, conductive table mat. This helps protect the analyzer and devices from electrostatic discharge (ESD).
- Refer to **“Connector Care Review” on page 537**.

CAUTION

Because of the very small and precise mechanical tolerances of mmWave connectors, minor defects, damage, and dirt can significantly degrade repeatability and accuracy. In addition, a dirty or damaged connector can destroy connectors that are mated to it. For this reason, NEVER use a damaged connector. See also http://na.support.keysight.com/pna/connectorcare/Connector_Care.htm

3 CAT (Cable and Antenna Test) Mode

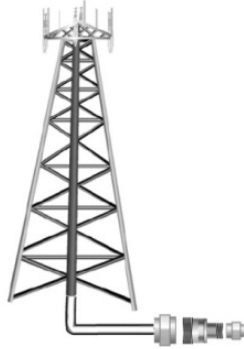

CAT Mode is typically used to test an entire transmission system, from the transmitter to the antenna. This process is sometimes referred to as Line Sweeping.

CAT Mode is similar to NA (Network Analyzer) Mode. Learn more in the Supplemental Online Help:

<http://na.support.keysight.com/fieldfox/help/SupHelp/FieldFox.htm>

CAT Mode Distance to Fault measurements are discussed in **Chapter 4, "DTF (Distance to Fault) Measurements."**

NOTE

IMPORTANT! For CAT and NA modes, limit lines do not apply where $F1 = F2$.

In this Chapter

"Measurement Selection" on page 45

"Quick Settings Table" on page 46

"Frequency Range" on page 47

"Scale Settings" on page 47

"Averaging" on page 48

"Smoothing" on page 49

"Single or Continuous Measure" on page 49

"Resolution (Number of Data Points)" on page 50

"Sweep Time" on page 50

"Output Power" on page 51

"Interference Rejection" on page 51

"Coupled Frequency" on page 52

CAT (Cable and Antenna Test) Mode

Procedures

“Return Loss Measurements” on page 53

“1-Port Cable Loss Measurements” on page 53

“2-Port Insertion Loss Measurements” on page 55

See Also

Chapter 8, “Calibration for NA, CAT, and VVM Modes”, on page 119

“All about Markers” on page 438

“All about Limit Lines” on page 453

“All about Trace Math” on page 458

Making 75 Ω (ohm) Measurements at the FieldFox Supplemental Online Help:
<http://na.support.keysight.com/fieldfox/help/SupHelp/FieldFox.htm>

CAT Mode Settings

Select CAT Mode before making any setting in this chapter.

How to select CAT Mode

- Press **Mode**.
- Then **CAT/TDR**.

Measurement Selection

How to select a CAT Mode Measurement

Learn more about the following measurements in the Supplemental Online Help: <http://na.support.keysight.com/fieldfox/help/SupHelp/FieldFox.htm>

Press **Measure 1**.

Then choose one of the following: These softkeys also appear after CAT Mode is selected.

- **Distance To Fault** 1-port reflection measurement that uses Inverse Fourier Transform (IFT) calculations to determine and display the distance to, and relative size of, a fault or disruption in the transmission line. Units are in return loss format, expressed as a positive number in dB, unless the measurement selected is DTF (VSWR). Learn more about DTF Measurements refer to **Chapter 4, “DTF (Distance to Fault) Measurements.”**
- **Return Loss & DTF** Displays both a Return Loss measurement and a DTF measurement. Use this format to display the frequency settings that are used to make the DTF measurement. The frequency range settings for these two measurements can be coupled or uncoupled. Learn more on **page 52**.

Calibrations are applied to both traces

When in Hold mode and Single sweep is performed, only the active trace is triggered. Use the **▲▼** arrows to activate a trace

- **Return Loss** 1-port reflection measurement that displays the amount of incident signal energy MINUS the amount of energy that is reflected. The higher the trace is on the screen, the more energy being reflected back to the FieldFox. Learn how to measure Return Loss on **page 53**.
- **VSWR** (Voltage Standing Wave Ratio – also known as SWR) 1-port reflection measurement that displays the ratio of the maximum reflected voltage over the minimum reflected voltage. The higher the trace is on the screen, the more energy being reflected back to the FieldFox.
- **DTF (VSWR)** Distance to Fault in VSWR format.

- **Cable Loss (1-Port)** 1-port reflection measurement that displays the loss of a transmission line. Learn more on [page 53](#)
- **Insertion Loss (2-Port)** 2-port transmission measurement that accurately displays the loss through a cable or other device in dB. Both ends of the cable must be connected to the FieldFox. NO phase information is included in this measurement. Learn more at [“2-Port Insertion Loss Measurements” on page 55](#). This feature is available only with an option on some FieldFox models. For detailed information, please view the FieldFox Configuration Guide at: <http://literature.cdn.keysight.com/litweb/pdf/5990-9836EN.pdf>
- **DTF (Lin)** Distance to Fault in Linear format.
- **TDR (Lin rho)** The Y-axis of the display is linear, real, unitless values. A trace without reflections shows as 0 (zero). Maximum reflections from an open or short show as 1.
- **TDR (ohm)** The Y-axis of the display is impedance (ohms).
- **TDR & DTF** TDR and DTF are displayed.

Quick Settings Table

Both CAT and NA Modes allow you to view and change most relevant settings from a single location. All of these settings are discussed in this chapter and, unless otherwise noted, ALL of these settings can also be made using the standard softkey menus.

How to view and change Quick Settings

- Press **Meas Setup 4**.
- Then **Settings**.
- Press **Next Page** and **Previous Page** to view all settings. If these softkeys are NOT available, then all available settings fit on one page.
- To change a setting:
 - Use the **▲▼** arrows to highlight a setting.
 - Then press **Edit**. The current setting changes to **yellow**.
 - Some settings require you to press a softkey to change the value. Otherwise, use the numeric keypad, **▲▼** arrows, or rotary knob to change the value.
 - When finished changing a value, press **Done Edit**.
- Press **Dock Window** to relocate the Settings table to a position relative to the trace window. The Dock Window setting persists through a Preset. Choose from the following
 - **Full** (Default setting) Only the Settings table is shown on the screen. The trace window is temporarily not shown

- **Left** The Settings table is shown to the left of the trace window
- **Bottom** The Settings table is shown below the trace window
- When finished changing ALL settings, press **Done** to save your settings

Frequency Range

Set the range of frequencies over which you would like to make CAT Mode measurements

When the frequency range is changed after a calibration is performed, the cal becomes interpolated. Learn more in [“Interpolation *” on page 138](#).

How to set Frequency Range

- Press **Freq/Dist**.
- Then choose from the following
 - **Start** and **Stop** frequencies - beginning and end of the sweep.
 - **Center** and **Span** frequencies – the center frequency and span of frequencies (half on either side of center).
- Follow each setting by entering a value using the numeric keypad, **▲▼** arrows, or the rotary knob.
 - After using the keypad, select a multiplier key. Learn about multiplier abbreviations in [Chapter 1, “Overview.”](#)
 - After using the **▲▼** arrows or the rotary knob, press **Enter**. The amount of frequency increment is based on the current span and can NOT be changed in CAT Mode.

Scale Settings

Adjust the Y-axis scale to see the relevant portions of the data trace. The Y-axis is divided into 10 graticules.

This setting can be changed at any time without affecting calibration accuracy.

How to set Scale

- Press **Scale / Amptd**.
- Then choose from the following three methods:
 1. **Autoscale** Automatically adjusts the Y-axis to comfortably fit the Minimum and Maximum amplitude of the trace on the screen.
 2. Set Scale, acquisition, and Reference Position:
 - **Scale** Manually enter a **scale per division** to view specific areas of the trace

- **Ref Level** Manually set the value of the reference line. Enter a negative value by pressing **Run/Hold (+/-)** either before or after typing a value
 - **Ref Pos** Manually set the position of the reference line. Values must be between **0** (TOP line) and **10** (BOTTOM line)
3. Set Top and Bottom graticule values. The scale per division is calculated.
- **Top** to set the value of the Top graticule.
 - **Bottom** to set the value of the Bottom graticule.
 - Enter a negative value by pressing **Run/Hold (+/-)** either before or after typing a value.

Scale annotation on the FieldFox screen

Reference Line = red arrow
Ref Level = -40 dB
Ref Position = 1
Scale = 2 dB per division

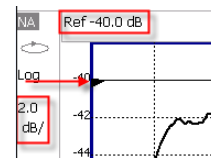

Averaging

Trace Averaging helps to smooth a trace to reduce the effects of random noise on a measurement. The FieldFox computes each data point based on the average of the same data point over several consecutive sweeps.

Average Count determines the number of sweeps to average; the higher the average count, the greater the amount of noise reduction.

An average counter is shown in the left edge of the screen as **Avg N**. This shows the number of previous sweeps that have been averaged together to form the current trace. When the counter reaches the specified count, then a 'running average' of the last **N** sweeps is displayed. Average Count = 1 means there is NO averaging.

This setting can be changed at any time without affecting calibration accuracy.

NOTE

Averaging is often used to increase the dynamic range of a measurement. To achieve the highest dynamic range, select NA mode and reduce the IF Bandwidth setting. Learn more about dynamic range in **"Increase Dynamic Range" on page 105**.

How to set Trace Averaging

- Press **BW 2**.

- Then **Average N** where **N** is the current count setting.
- Enter a value using the numeric keypad. Enter 1 for NO averaging.
- Press **Enter**.
- While Trace Averaging is in process, press **Sweep 3** then **Restart** to restart the averaging at 1.

Smoothing

Trace smoothing averages a number of adjacent data points to smooth the peak-to-peak noise values on a displayed trace. The number of adjacent data points that are averaged is known as the smoothing aperture. Aperture is set by specifying a percentage of the X-axis span.

Trace smoothing does NOT significantly increase measurement time.

Smoothing can be used with any CAT format.

When enabled, **Smo** appears on the FieldFox screen.

How to set Smoothing

- Press **BW 2**.
- Then **Smoothing ON OFF**.
- Then **Sm. Aperture** and enter a value between 0 and 25 (percent) using the numeric keypad.
- Press **Enter**.

Single or Continuous Measure

This setting determines whether the FieldFox sweeps continuously or only once each time the **Single** button is pressed. Use **Single** to conserve battery power or to allow you to save or analyze a specific measurement trace.

This setting can be changed at any time without affecting calibration accuracy.

How to set Single or Continuous

- Press **Sweep 3**.
- Then choose one of the following:
 - **Single** Automatically sets Continuous OFF and causes FieldFox to make ONE sweep, then hold for the next Single key press. Hold is annotated in the upper left corner of the display when NOT sweeping, and changes to an arrow --> while the sweep occurs
 - **Continuous** Makes continuous sweeps. This is the typical setting when battery power is not critical.

You can also use **Run / Hold +/-** to toggle between Single and Continuous.

Resolution (Number of Data Points)

Data points are individual measurements that are made and plotted across the X-axis to form a trace. Select more data points to increase measurement resolution. However, more data points require more time to complete an entire measurement sweep

When the Resolution is changed after a calibration is performed, the cal becomes interpolated. Learn more in [“Interpolation *” on page 138](#)

How to set Resolution

- Press **Sweep 3**.
- Then **Resolution**.
- Then choose one of the following:
101 | 201 | 401 | 601 | 801 | 1001 | 1601 | 4001 | 10001.
- Using SCPI, Resolution can be set to any number of points between 3 and 10001. See the Programming Guide at <http://na.support.keysight.com/fieldfox/help/>

Sweep Time

The fastest possible sweep time is always used as the default setting. Use the **Min Swp Time** setting to slow the sweep time when measuring long lengths of cable.

Learn more in the FieldFox Supplemental Help at:

<http://na.support.keysight.com/fieldfox/help/SupHelp/FieldFox.htm>

The actual sweep time is shown on the FieldFox screen. See [“Take the FieldFox Tour” on page 33](#). To increase the sweep time, enter a value that is higher than the actual sweep time. The increase will not be exactly the amount that you enter, as the actual sweep time is the composite of many factors.

NOTE

Measurement speed specifications do NOT apply in Temperature Control Mode. Learn more in [Chapter 1, “Overview.”](#)

How to set Sweep Time

- Press **Sweep 3**.
- Then **Min Swp Time**.
- Enter a value using the numeric keypad.
- Press a multiplier key. Learn more in [“Multiplier Abbreviations” on page 41](#).

Output Power

Set the power level out of the FieldFox to High, Low, or manually set power level to a value between High and Low.

Generally, the high power setting is used when measuring passive, high-loss devices to place the signal farther from the noise floor. However, for devices that are sensitive to high power levels such as amplifiers, use the Low power setting.

For best measurement accuracy, use the Manual power setting at -15 dBm. After calibration, the power level can be decreased for amplifiers, or increased for higher dynamic range.

CAUTION

Power Level settings in this mode will NOT change Power Level settings in other modes. To help prevent damage to your DUT, use caution when changing modes with your DUT connected to the FieldFox test ports.

How to set Output Power

- Press **Meas Setup 4**.
- Then **Power**
- Then **Output Power**
 - **High** (Default setting) Sets output power to the maximum achievable power at all displayed frequencies. Output power is NOT FLAT across the displayed FieldFox frequency span. Please see **“Specifications/Data Sheet” on page 541** for expected power levels.
 - **Low** Sets output power to approximately -45 dBm, FLAT across the displayed FieldFox frequency span.
 - **Man** Set output power to an arbitrary value, FLAT across the displayed FieldFox frequency span. If flattened power can NOT be achieved, a warning message and beep occurs. To achieve a flattened output power, reduce the power level or stop frequency.
 - Then press **Power Level**
 - Then enter a value using the numeric keypad, the **▲▼** arrows, or the rotary knob.
 - Press **Enter**.

Interference Rejection

Use this setting when you suspect that other signals in the area are interfering with a measurement. Interference may look like a spike or lack of stability in the measurement trace. While monitoring a measurement at a specific frequency,

toggle this setting between ON and OFF. If the measurement result decreases while ON, then there is an interfering signal in the area. Continue to make measurements with Interference Rejection ON. However, this will slow the measurement speed.

Once enabled, up to SIX sweeps may be required before the interfering signal is neutralized.

This setting can be changed at any time without affecting calibration accuracy.

How to set Interference Rejection

- Press **Meas Setup 4**.
- Then **Interference Rejection [current setting]**.
- Then choose from the following:
 - **Off** No interference rejection and fastest possible sweep speed
 - **Minimum** The lowest level of Interference rejection.
 - **Medium** The medium level of Interference rejection.
 - **Maximum** The highest level of Interference rejection.

Coupled Frequency

This setting, especially useful for a Return Loss & DTF measurement, allows both measurements to have different frequency ranges.

How to set Coupled Frequency

With a Return Loss & DTF measurement present:

- Press **Meas Setup 4**.
- Select the DTF measurement (Tr2) using the **▲▼** arrows.
- Then choose from the following:
 - **Coupled Freq ON** - Both the Return Loss and DTF traces have the same frequency range settings.
 - **Coupled Freq OFF** (default setting) - Both traces are allowed to have individual frequency range settings. When set to OFF:
 - The Return Loss measurement frequency settings are made in the usual manner. Learn how at **“Frequency Range” on page 47**. When a new Start or Stop frequency is selected, Coupled Frequency is automatically set to OFF.
 - The DTF measurement is made using the frequencies as determined by the **DTF Frequency Mode** setting. Learn more in **“DTF Measurement Settings” on page 60**.

Return Loss Measurements

Return loss can be thought of as the absolute value of the reflected power compared to the incident power.

When measuring an OPEN or SHORT, all incident power is reflected and approximately 0 dB return loss is displayed.

When measuring a LOAD, very little power is reflected and values of 40 dB to 60 dB are displayed.

The minus sign is usually ignored when conveying return loss. For example, a component is said to have 18 dB return loss, rather than -18 dB.

How to Measure Return Loss

- Connect the jumper cable or any adapter used to connect the device under test (DUT).
- Select **Preset** then **Preset** Returns the FieldFox to known settings
- Select **Mode** then **CAT/TDR** (Cable and Antenna Test)
- Then **Return Loss** (Default measurement).
- Press **Freq/Dist** and enter **Start** and **Stop** frequency values of the measurement.
- Press **Meas Setup 4** then **Settings** to make appropriate settings before calibrating.
- Disconnect the jumper cable or DUT and press **Cal 5** then follow the calibration prompts.
- Reconnect the jumper cable or DUT.
- The return loss trace is displayed on the FieldFox screen.

1-Port Cable Loss Measurements

While all cables have inherent loss, weather and time will deteriorate cables and cause even more energy to be absorbed by the cable. This makes less power available to be transmitted.

A deteriorated cable is not usually apparent in a Distance to Fault measurement, where more obvious and dramatic problems are identified. A Cable Loss measurement is necessary to measure the accumulated losses throughout the length of the cable.

A 2-port Insertion Loss measurement is usually more accurate than a 1-port Cable Loss measurement. However, to perform a 2-port Insertion Loss measurement, both ends of the cable must be connected to the FieldFox.

NOTE

In high-loss conditions, a Cable Loss measurement becomes 'noisy' as the test signal becomes indistinguishable in the FieldFox noise floor. This can occur when measuring a very long cable and using relatively high measurement frequencies. To help with this condition, use High Power (page 51) and Averaging. (page 48).

How to make a 1-port Cable Loss Measurement

1. Press **Preset** then **Preset**.
2. Then **More** then **Cable Loss (1-Port)**
3. Connect the cable to be tested.
4. Press **Freq/Dist** and enter **Start** and **Stop** frequency values of the measurement.
5. Press **Sweep 3** then **Min Swp Time**. Increase the Sweep Time until a stable trace is visible on the screen. The amount of time that is required increases with longer cable lengths. Learn more in the **Supplemental Online Help**: <http://na.support.keysight.com/fieldfox/help/SupHelp/FieldFox.htm>
6. Remove the cable to be tested.
7. Press **Cal 5**, then **QuickCal** or **Mechanical Cal**. Mechanical Cal.

NOTE

QuickCal is only available on N991xA/2xA/3xA models.

8. Follow the prompts to perform calibration at the end of the jumper cable or adapter. Learn more about Calibration in "[How to Perform a Calibration](#)" on page 121
9. Connect the cable to be tested.

NOTE

Low-level standing waves (also known as 'ripple') which may be visible in reflection measurements, can hide the actual loss of the cable. Steps 10 through 13 can minimize the ripple. Perform the measurement with and without steps 10 through 13 and choose the method with the least amount of ripple.

10. Connect a LOAD at the end of the cable to be tested. This limits the reflections to faults that are located in the cable under test.
11. Press **Trace 6** then **Math and Memory** then **Data->Mem** to store the trace into Memory.
12. Remove the LOAD and leave the end of the cable to be tested open.

13. Press **Data Math** then **Data – Mem**. The ripple in the measurement is removed. These minor imperfections in the cable should not be considered in the Cable Loss measurement.

14. Use **Averaging** to remove random noise from high-loss measurements. Press **BW 2** then **Average**.

The displayed trace shows the Cable Loss values in one direction through the cable. A Return Loss measurement would show the loss for both down the cable and back. Therefore, a Cable Loss measurement is the same as a Return Loss measurement divided by 2.

The average Cable Loss across the specified frequency range is shown on the screen below the graticules.

2-Port Insertion Loss Measurements

A 2-port Insertion Loss measurement is used to measure the loss through a DUT (device under test) – or cable – over a specified frequency range. The FieldFox signal source is transmitted out the RF OUT connector, through the DUT, and into the RF IN connector. Both ends of the DUT must be connected to the FieldFox, either directly or indirectly using the cable used in the normalization cal.

‘Insertion’ loss simply means **loss** through a device, usually expressed in dB. It is exactly the same measurement as “S21 Transmission” in NA Mode.

2-port Insertion Loss measurements are generally more accurate than 1-port Cable Loss measurements.

How to make a 2-port Insertion Loss Measurement

- Press **Mode** then **CAT.f**
- Then **More** then **Insertion Loss (2-Port)**.
- Press **Freq/Dist** and enter **Start** and **Stop** frequency values of the measurement.
- Press **Sweep 3**, then select a **Resolution** setting.
- Press **Cal 5**, then perform a calibration. Learn more on “**How to Perform a Calibration**” on page 121.
- Connect the DUT and view the insertion loss measurement results.

When measuring very long lengths of cable, it may be necessary to increase the sweep time. Learn how on page 50. Learn why in the **Supplemental Online Help**: <http://na.support.keysight.com/fieldfox/help/SupHelp/FieldFox.htm>

CAT (Cable and Antenna Test) Mode
2-Port Insertion Loss Measurements

4 DTF (Distance to Fault) Measurements

CAT Mode **Distance to Fault** (DTF) measurements are generally used to locate problems, or faults, in a length of cable or transmission line. In this chapter, the cable to be tested is referred to as the DUT (Device Under Test).

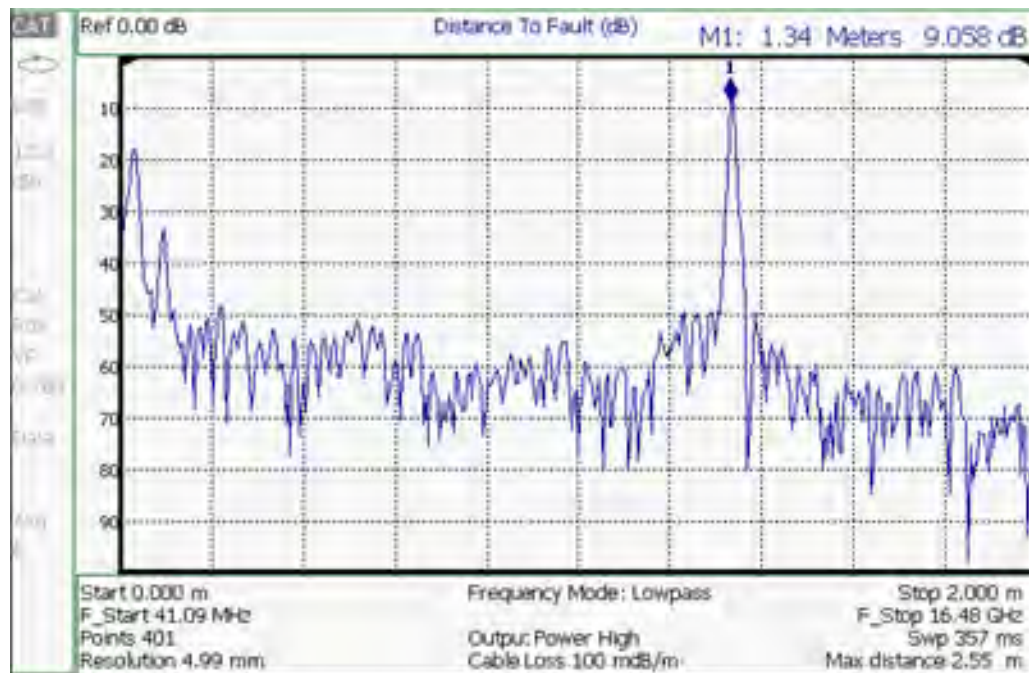

Settings that are NOT unique to DTF measurements are documented in the CAT Mode [Chapter 3, “CAT \(Cable and Antenna Test\) Mode.”](#)

In this Chapter

[“How to make DTF Measurements” on page 58](#)

[“DTF Settings Table” on page 60](#)

[“DTF Measurement \(Format\)” on page 60](#)

[“DTF Start and Stop Distance” on page 61](#)

[“Frequency Mode” on page 61](#)

[“Coupled Frequency” on page 62](#)

[“Cable \(Correction\) Specifications” on page 63](#)

[“Window Settings” on page 66](#)

[“DTF Units” on page 67](#)

[“Calculated DTF values” on page 67](#)

[“About Alias Faults” on page 67](#)

Optional settings

[“All about Markers” on page 438](#)

[“All about Limit Lines” on page 453](#)

[“Saving and Recalling Files” on page 498](#)

Trace Math is NOT available in DTF Measurements.

How to make DTF Measurements

Before starting, you may need the following:

- Jumper cable or adapter to connect the beginning of the DUT to the FieldFox.
- LOAD with correct connector type and gender to terminate the end of the DUT (if possible).
- The known length and cable type of the DUT. If the cable type is not known, then the Cable Loss (dB/Meter) and Velocity Factor of the DUT are required.

1. Connect any necessary jumper cable or adapter to the FieldFox RF OUT port. Do NOT connect the DUT.
2. Press **Preset** then **Preset** to return the FieldFox to the default settings.
3. Then **Mode** then **CAI**.
4. Then **Meas 1** then **DTF**.
5. Press **Freq/Dist**, then **Stop Distance** and enter the length of the DUT. You can optionally set the Start Distance
6. Press **Cal 5** and follow the Cal prompts. Learn all about Calibration in [“How to Perform a Calibration” on page 121](#).
7. Disconnect any components or antenna that should NOT be measured and connect a LOAD at the end of the DUT.
8. Press **Meas Setup 4** then **DTF Cable Specifications**.

DTF (Distance to Fault) Measurements
How to make DTF Measurements

9. Either press **Edit/Save/Recall Cables** then **Recall Cable**, or directly enter the Velocity Factor/Cable Loss of the DUT using the **Velocity Factor** and **Cable Loss** keys.
10. Connect the start end of the DUT to the FieldFox.
11. Press **Meas Setup 4** then **Settings** then **Next Page**. If the **Alias-free Range** setting is False, then you may see Alias faults on the screen. Learn more on [page 67](#).

DTF Measurement Settings

DTF Settings Table

You can set and view all of the DTF settings, including some calculated values, on the DTF Settings table. Learn about the calculated values in **“Calculated DTF values” on page 67**.

How to make settings on the DTF settings table

- Press **Meas Setup 4**.
- Then **Settings**.
- Press **Next Page** and **Previous Page** to view all settings.
- To change a setting:
 - Use the **▲▼** arrows or rotary knob to highlight a setting.
 - Numeric settings can be changed by pressing numbers using the numeric keypad. Then press Enter or select a suffix if available.
 - Other settings require you to press **Edit**, then press a softkey to change the value.
 - When finished changing a value, press **Done Edit**.
- Press **Dock Window** to relocate the Settings table to a position relative to the trace window. The setting persists through a Preset. Choose from the following:
 - **Full (Default setting)** Only the Settings table is shown on the screen. The trace window is temporarily not shown.
 - **Left** The Settings table is shown to the left of the trace window.
 - **Bottom** The Settings table is shown below the trace window.
- When finished changing ALL settings, press **Done** to save your settings.

DTF Measurement (Format)

You can select from 3 different DTF Formats.

- Press **Measure 1**
- Then choose from:
 - **Distance to Fault (dB)** Faults are displayed on the Y-axis in return loss format, expressed as a positive number in dB.
 - **DTF (VSWR)** Faults are displayed on the Y-axis in SWR. Learn more about SWR at the FieldFox Supplemental Online Help: <http://na.support.keysight.com/fieldfox/help/SupHelp/FieldFox.htm>

DTF (Distance to Fault) Measurements DTF Measurement Settings

- **More** then **DTF (Lin)** Faults are displayed on the Y-axis in linear (unitless) format.

DTF Start and Stop Distance

In DTF measurements, you set the physical length of cable or other device to be tested. The FieldFox calculates the frequency range of the measurement from this distance. The longer the cable to be tested, the lower the frequencies that are used. You can also set the frequencies manually using the Frequency Mode [Bandpass] setting.

How to set Start and Stop Distance

- With a DTF measurement present, press **Freq/Dist**.
- Then choose from the following:
 - **Start Distance** Enter a value using the numeric keypad, the **▲▼** arrows, or the rotary knob, then **Enter**. By default, the Start Distance is set to 0 Meters. This means that the measurement will display faults starting at the point at which calibration standards are connected.
 - **Stop Distance** Enter a value between the start distance and 5 km (or 16,404 ft.) using the numeric keypad, the **▲▼** arrows, or the rotary knob, then **Enter**.

Frequency Mode

All DTF measurements are made with frequency settings and, using Inverse Fourier Transform (IFT), the time and distance to faults are calculated.

NOTE

The start and stop frequencies for the measurement are always annotated on the screen below the start and stop distances.

How to set Frequency Mode

With a DTF measurement present,

- Press **Meas Setup 4**
- Then **Frequency Mode**
- Choose one of the following:
 - **Lowpass** The frequency range of a DTF measurement is set automatically based on the Start and Stop Distances. Use Lowpass mode when the DUT is a cable ONLY.

DTF (Distance to Fault) Measurements DTF Measurement Settings

- **Bandpass** (Default setting) The frequency range of a DTF measurement is set manually. Use Bandpass mode when the DUT contains a diplexer or other filtering device which does not pass some frequencies.

Typically, you will set the frequency range of the measurement to the passband of the filter. However, you may also want to test the ability of the filter to reject unwanted frequencies. In this case, set the frequency range to include those frequencies which the filter may not be adequately rejecting.

How to manually set Frequencies in Bandpass Mode

- Press **Freq/Dist**
- Then **Min Start Freq** and type the start frequency to use for the DTF measurement.
- Then **Max Stop Freq** and type the stop frequency to use for the DTF measurement.
- OR
- Press **More**
- Then **Max Freq Span** and type the frequency range to use for the DTF measurement.
- Then **Center Frequency** and type the center frequency of the range to use for the DTF measurement.

When the DTF frequencies are set manually, they may not be the optimum frequencies for measuring the distance to fault. The distance may no longer be alias-free. Learn more about alias-free range on [page 67](#).

These settings specify the minimum and maximum frequencies to be used for the DTF measurement. These exact frequencies may not be used, but a narrower frequency range may be used that will still pass through the bandpass filter.

Coupled Frequency

When a Return Loss & DTF measurement is present, this setting allows you to have different frequency ranges for each measurement. Learn more in [“Coupled Frequency” on page 52](#).

Cable (Correction) Specifications

By default, the FieldFox does NOT correct DTF measurements to account for the inherent loss of a cable. However, to make more accurate DTF measurements, the Cable Loss and Velocity Factor values should be considered.

NOTE

The following describes Coax Media type. However, you can create or edit Waveguide Media Standards. Learn how in [“Waveguide Calibrations” on page 135](#).

About Velocity Factor and Cable Loss

- Velocity Factor is a property of the physical material of a cable. A VF of 1.0 corresponds to the speed of light in a vacuum, or the fastest VF possible. A polyethylene dielectric cable has VF = 0.66 and a cable with PTFE dielectric has VF = 0.7.
- Cable Loss is specified in dB/meter. In addition to the length of the cable, loss is also directly proportional to the frequency of the signal that passes through the cable.

The following is an example showing how DTF cable correction works:

The DUT is a 100 meter transmission cable. The Cable Loss value is 0.1 dB/meter. This means that a signal traveling ONE WAY through the cable will lose 10 dB of power ($100 \text{ m} * 1 \text{ dB/m}$). Because the FieldFox performs this measurement with 1 port, the test signal travels down the cable and then back, for a total loss of 20 dB.

After a calibration has been performed, for the purpose of illustrating this point, connect an OPEN to the end of the cable – a maximum-sized fault – for 100% reflection of the 300 MHz test signal.

Without compensation for the loss of the cable, a –20 dB response would be visible at 100 meters, which is the OPEN at the end of the DUT. This is from 10 dB of loss through the cable in each direction.

With compensation for the loss using the manufacturer’s specification, the FieldFox compensates the trace as though the signal traveling through 100 meters was increased by +20 dB. Therefore the response will show 0 dB for 100% reflection.

How to enter Cable Loss and Velocity Factor

Cable Loss and Velocity factor can be entered using one of the following methods:

- Manually enter cable loss and velocity factor for the measurement.
- Select or create a cable file which contains the cable loss and velocity factor.

With a DTF measurement present:

DTF (Distance to Fault) Measurements

DTF Measurement Settings

- Press **Meas Setup 4**.
- Then **DTF Cable Specifications**
- Select **Cable Corr**
 - **Auto** Use Cable Loss and Velocity Factor values from a Cable file. See “How to Edit, Save, and Recall a Cable File” below. This will overwrite a manually-entered value.
 - **Man** (Default setting) Manually enter a value for Cable Loss and Velocity Factor.
- Then:
 - **Velocity Factor** Using the numeric keypad, enter a value between 0.01 and 1. Then press **Enter**.
 - **Cable Loss** Using the numeric keypad, enter a positive Cable Loss value in dB/m, then press **Enter**.

How to Edit a Cable File

The FieldFox includes many predefined cable files with the manufacturer’s specifications. You can edit these files or create new cable files using the following procedure or using the FieldFox Data Link Software.

The Cable correction data survives a Mode Preset and Preset.

With a DTF measurement present:

- Press **Meas Setup 4**
- Then **DTF Cable Specifications**
- Then **Edit/Save/Recall Cables**
- Press **New Cable** then **Yes** to clear all data from the existing DTF Cable table and reset header information to default settings.
- Then **Edit Cable** to open the Cable Editor.
- Then use the **▲▼** arrows to select a field,
 - When editing Cable Description information, press **Edit** then modify the selected field using the FieldFox labeler.
 - When editing Frequency/Loss pairs, enter numbers using the numeric keypad, then select a frequency suffix. Then **Enter**. Learn more about “How the Freq/Loss pairs are applied” below.
- Optionally choose from the following:
 - **Previous / Next Page** Quickly scrolls through pages of Freq/Loss data.
 - **Add Data** Add a blank Freq/Loss pair to the table,

- **Delete/Clear** then:
- **Delete Row** Remove the selected Freq/Loss pair from the table.
- **Clear All** then **Yes**. Remove all Freq/Loss pairs from the table and resets header information
- Press **Done** to close the Cable Editor.

How to Save or Recall a Cable

- Press **Save Cable** to save your changes to the specified Storage Device. Enter a filename using the FieldFox labeler (learn more on [“How to use the FieldFox labeler ” on page 500](#)). Learn more about Cable files below.
- Press **Recall Cable** to load a Cable file from the specified Storage Device
- **Storage Device** Changes the device used to save or recall Cable files. This is a different setting from the Save/Recall Storage Device setting. Choose from Internal (default setting), **USB** (must be connected) or **SD card**.

About Cable files

- Cable files are saved to, and recalled from, the **Cables** folder. If the folder does not already exist on a USB or SD card, it is created automatically before storing the file.
- Cable files are stored as *.xml files. Existing cable files that are preloaded into the FieldFox firmware can be overwritten. Your edited file will NOT be overwritten when firmware is updated.
- To **DELETE** a Cable file, use the Manage Files feature. Learn more in [“Manage Files” on page 506](#).

How the Freq/Loss pairs are applied

When the cable file contains one Freq/Loss pair, that correction value is applied to the entire displayed frequency span.

When the cable file contains two or more Freq/Loss pairs, the Loss value that is used is interpolated from the Freq/Loss pairs and the DTF center frequency. For example, using a cable file with the following Freq/Loss pairs:

1 GHz: 0.1 dB/m
2 GHz: 0.2 dB/m

The center frequency for the measurement is determined from the calculated (Stop – Start) frequency values (seen on the second page of DTF Settings):

Calculated Start = 2.0 MHz

Calculated Stop = 3.598 GHz

Center Freq = 1.80 GHz

The Loss value for the measurement is interpolated from the Freq/Loss pairs at the Center Freq:

1 GHz = 0.1 dB/m

1.8 GHz = 0.18 dB/m

2 GHz = 0.2 dB/m

The correction for loss at 5 meters in one direction: $0.18 \text{ dB/m} * 5\text{m} = 0.9 \text{ dB}$.

All DTF measurements correct for loss for travel down the DUT and back, so double the correction: $0.9 \text{ dB} * 2 = 1.8 \text{ dB}$.

Window Settings

Window settings provide the ability to choose between optimizing DTF measurements for resolving closely-spaced faults or for the ability to measure low-level faults.

How to select Window settings

- Press **Meas Setup 4**.
- Then **Settings**.
- Then press **▲▼** arrows to move to the Window row.
- Then press **Edit**.
- Then press **Window** and choose from the following:
 - **Maximum (Maximum – Optimized for dynamic range)** the noise floor is lowered to provide the ability to measure low-level responses. (Default setting)
 - **Medium** – Compromise between Minimum and Maximum window settings.
 - **Minimum** – Best Response Resolution, providing the ability to resolve between two closely-spaced responses.
- Then press **Done Edit**.
- Again press **Done**.

DTF Units

The DTF Units setting is available ONLY on the DTF Settings table.

By default, X-axis units for DTF measurement settings are displayed in Meters.

How to change DTF units

- With a DTF measurement present, press **Freq/Dist**.
- Then **More** then **Distance Unit m feet**.
- The current selection is underlined **m (meters) Feet**.

Calculated DTF values

Press **Next Page** on the DTF Settings Table to view the following **calculated Values** noted on the FieldFox screen with c - <setting>

Start Frequency – Start frequency that is used to calculate DTF.

Stop Frequency – Stop frequency that is used to calculate DTF.

Range Resolution. Indicates the accuracy of the distance to fault measurement. For example, with range resolution of 500 mm, if the distance to fault is 10 meters, this value could be inaccurate by +/- 500 mm or between 9.5 to 10.5 meters. This value is calculated from frequency span / resolution (points).

Response Resolution, not displayed, indicates the distance that could be between two faults and still show as separate faults. Learn more in **“Window Settings” on page 66**.

Maximum Distance. The distance that could be viewed with the current settings. Defined by: $V_f * c * Points / (2 * Bandwidth)$ where:

- V_f = velocity factor
- c = speed of light
- Points = resolution
- Bandwidth = frequency range

Alias-free Range (On/Off)

- On = No Alias images
- Off = Alias images may appear in the response.

About Alias Faults

An alias fault is not a true device response. An alias fault appears because of the method used to convert frequency to time.

On the DTF Settings page (above) the c - Alias-free Range = Off setting indicates alias images MAY appear on the screen.

Shorter stop distances (less than 10 meters) and a higher resolution (1001 points) will be **more** likely to result in **Alias-free Range = Off**.

When the Alias-free Range = Off, the following procedure will help to determine if a response is true or an alias response:

- 1. Put a marker on the response in question and note the distance to the fault.**
- 2. Change the start or stop distance.**

A true fault response will not move in distance. That is, if a true fault is present at 10.3 meters, changing the stop distance from 15 m to 20 m will not move the fault; the fault will remain at 10.3 meters. However, an alias response will appear to move.

An un-terminated cable (with NO perfect load at the end) will show faults that appear to be beyond the end of the cable. These are NOT alias faults. These faults appear as the signal reflects off the open at the end of the cable and travels back down the cable toward the connection at the FieldFox.

Re-reflections are measured at the FieldFox as mirror images of the original faults. The largest fault is the open end of the cable. To avoid confusion, set the Stop distance shortly after that fault.

5 TDR (Time Domain Reflectometry) - Option 215

CAT Mode **Time Domain Reflectometry (TDR)** measurements are generally used to locate problems, and identify the type of problem, in a length of cable or transmission line.

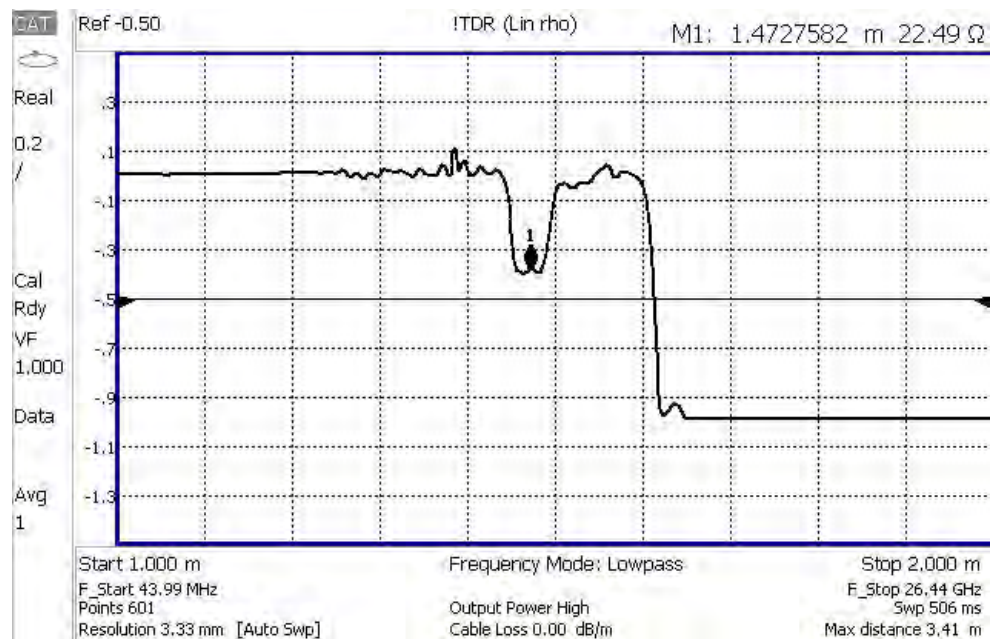

Settings that are NOT unique to TDR measurements are documented in [Chapter 3, "CAT \(Cable and Antenna Test\) Mode", on page 43](#).

In this chapter, the cable to be tested is referred to as the DUT (Device Under Test).

In this Chapter

["TDR Measurement \(Format\)" on page 72](#)

["TDR Settings Table" on page 72](#)

["TDR Start and Stop Distance" on page 73](#)

["TDR Sweep" on page 73](#)

[“Frequency Mode” on page 74](#)

[“Cable \(Correction\) Specifications” on page 75](#)

[“Window Settings” on page 78](#)

[“TDR Units” on page 79](#)

[“Calculated TDR values” on page 79](#)

[“About Alias Faults” on page 80](#)

[“How to Prevent Undersampling” on page 81](#)

Optional Settings

[“All about Markers” on page 438](#)

[“All about Limit Lines” on page 453](#)

[“Saving and Recalling Files” on page 498](#)

Trace Math is NOT available in DTF Measurements.

How to make TDR Measurements

Before starting, you may need the following:

- Jumper cable or adapter to connect the beginning of the DUT to the FieldFox.
- LOAD with correct connector type and gender to terminate the end of the DUT (if possible).
- The known length and cable type of the DUT. If the cable type is not known, then the Cable Loss (dB/Meter) and Velocity Factor of the DUT are required.

1. Connect any necessary jumper cable or adapter to the FieldFox RF OUT port. Do NOT connect the DUT.
2. Press **Preset** then **Preset** to return the FieldFox to the default settings.
3. Then **Mode** then **CAT/TDR**.
4. Then **Meas 1** then **More** then **DTF (Lin)** or **TDR (Lin rho)** or **(ohm)**.
5. Press **Freq/Dist**, then **Stop Distance** and enter the length of the DUT. You can optionally set the **Start Distance**
6. Press **Cal 5** and follow the Cal prompts. Learn all about Calibration in [“How to Perform a Calibration” on page 121](#).
7. Disconnect any components or antenna that should NOT be measured and connect a LOAD at the end of the DUT.
8. Press **Meas Setup 4** then **DTF Cable Specifications**.

9. Either press **Edit/Save/Recall Cables** then **Recall Cable**, or directly enter the Velocity Factor/Cable Loss of the DUT using the **Velocity Factor** and **Cable Loss** keys.
10. Connect the start end of the DUT to the FieldFox.
11. Press **Meas Setup 4** then **Settings** then **Next Page**. If the **Alias-free Range** setting is **Off**, then you may see Alias faults on the screen. Learn more in [“About Alias Faults” on page 80](#)

TDR Measurement Settings

Select CAT Mode, then TDR before making any setting in this chapter.

How to select CAT Mode

- Press **Mode**.
- Then **CAT/TDR**.

TDR Measurement (Format)

You can select from 3 different TDR Formats.

- Press **Measure 1**
- Then **More**.
- Then choose from:
 - **TDR (Lin rho)** The Y-axis of the display is linear, real, unitless values. A trace without reflections shows as 0 (zero). Maximum reflections from an open or short show as 1.
 - **TDR (ohm)** The Y-axis of the display is impedance (ohms).m
 - **DTF (Lin)** The Y-axis of the display is linear, real, unitless values. X-Axis displays distance to fault in meters.
 - TDR & DTF TDR and DTF are displayed.

TDR Settings Table

You can set and view all of the TDR settings, including some calculated values, on the TDR Settings table. Learn more in [“Calculated TDR values” on page 79](#).

How to make settings on the TDR settings table

- Press **Meas Setup 4**.
- Then **Settings**.
- Press **Next Page** and **Previous Page** to view all settings.
- To change a setting:
 - Use the **▲▼** arrows or rotary knob to highlight a setting.
 - Numeric settings can be changed by pressing numbers using the numeric keypad. Then press Enter or select a suffix if available.
 - Other settings require you to press **Edit**, then press a softkey to change the value.
 - When finished changing a value, press **Done Edit**.

- Press **Dock Window** to relocate the Settings table to a position relative to the trace window. The setting persists through a Preset. Choose from the following:
 - **Full (Default setting)** Only the Settings table is shown on the screen. The trace window is temporarily not shown.
 - **Left** The Settings table is shown to the left of the trace window.
 - **Bottom** The Settings table is shown below the trace window.
- When finished changing ALL settings, press **Done** to save your settings.

The following TDR settings are available ONLY on the settings table:

Mkr Format – The format of marker readout. Choose from:

- **Z Magnitude** – Impedance (magnitude only)
- **Default** – The current TDR measurement format.

Auto: Max Freq – When TDR Sweep is set to Auto, this is the maximum stop frequency of the measurement. The minimum value of this setting is 100 MHz.

TDR Start and Stop Distance

In TDR measurements, you set the physical length of the DUT. The FieldFox calculates the frequency range of the measurement from this distance. The longer the DUT, the lower the frequencies that are used.

You can NOT set the frequencies manually in TDR. However, you CAN limit the maximum frequency using the TDR Sweep setting. Learn more in [“TDR Sweep” on page 73](#).

How to set Start and Stop Distance

- With a TDR measurement present, press **Freq/Dist**.
- Then choose from the following:
 - **Start Distance** Enter a value using the numeric keypad, the **▲▼** arrows, or the rotary knob, then **Enter**. By default, the Start Distance is set to **0** Meters. This means that the measurement will display faults starting at the point at which calibration standards are connected.
 - **Stop Distance** Enter a value between the start distance and **5 km** (or 16,404 ft.) using the numeric keypad, the **▲▼** arrows, or the rotary knob, then **Enter**.

TDR Sweep

This setting allows you to choose the method by which the Stop Frequency and Resolution are set.

- Press **Sweep 3**
- Then **TDR Sweep**
- Choose one of the following:
 - **Auto** Low pass frequency settings are calculated based on the current number of points. The Stop Frequency and Resolution settings can be changed to any value.
 - To set Stop Frequency, press **Meas 4**, then **Settings**, then scroll to Auto: Max Freq.
 - To set Resolution, press **Sweep 3**, then **Resolution**.
 - **Cable** Provides a higher resolution measurement. Use when under-sampling is suspected. The Stop Frequency is limited to 500 MHz maximum. The Resolution is fixed to 1601.

NOTE

Because of its greater measurement accuracy, **Cable** is the default setting in CPU1 units with firmware A.08.18 and greater and CPU2 units with firmware A.09.57 and greater. Refer to **“Preferences” on page 469**.

Frequency Mode

All TDR measurements are made with frequency settings and, using Inverse Fourier Transform (IFT), the time and distance to faults are calculated.

NOTE

The start and stop frequencies for the measurement are always annotated on the screen below the start and stop distances.

How to set Frequency Mode

With a TDR measurement present,

- Press **Meas Setup 4**
- Then **Freq Mode**
- Choose one of the following:
 - **Lowpass** The frequency range of a TDR measurement is set automatically based on the Start and Stop Distances. Use Lowpass mode when the DUT is a cable ONLY.
 - **Bandpass** This setting changes the measurement to DTF. Bandpass is NOT ALLOWED with TDR because the DC component is required for TDR measurements.

Cable (Correction) Specifications

By default, the FieldFox does NOT correct TDR measurements to account for the inherent loss of a cable. However, to make more accurate TDR measurements, the Cable Loss and Velocity Factor values should be considered.

NOTE

The following describes Coax Media type. Waveguide Media can NOT be measured with TDR as waveguide is inherently a high pass device.

About Velocity Factor and Cable Loss

- Velocity Factor is a property of the physical material of a cable. A VF of 1.0 corresponds to the speed of light in a vacuum, or the fastest VF possible. A polyethylene dielectric cable has $VF = 0.66$ and a cable with PTFE dielectric has $VF = 0.7$.
- Cable Loss is specified in dB/meter. In addition to the length of the cable, loss is also directly proportional to the frequency of the signal that passes through the cable.

The following is an example showing how DTF cable correction works:

The DUT is a 100 meter transmission cable. The Cable Loss value is 0.1 dB/meter. This means that a signal traveling ONE WAY through the cable will lose 10 dB of power ($100 \text{ m} * 1 \text{ dB/m}$). Because the FieldFox performs this measurement with 1 port, the test signal travels down the cable and then back, for a total loss of 20 dB.

After a calibration has been performed, for the purpose of illustrating this point, connect an OPEN to the end of the cable – a maximum-sized fault – for 100% reflection of the 300 MHz test signal.

Without compensation for the loss of the cable, a -20 dB response would be visible at 100 meters, which is the OPEN at the end of the DUT. This is from 10 dB of loss through the cable in each direction.

With compensation for the loss using the manufacturer's specification, the FieldFox compensates the trace as though the signal traveling through 100 meters was increased by $+20 \text{ dB}$. Therefore the response will show 0 dB for 100% reflection.

How to enter Cable Loss and Velocity Factor

Cable Loss and Velocity factor can be entered using one of the following methods:

- Manually enter cable loss and velocity factor for the measurement.
- Select or create a cable file which contains the cable loss and velocity factor.

With a TDR measurement present:

- Press **Meas Setup 4**.

- Then **DTF Cable Specifications**
- Select **Cable Corr**
 - **Auto** Use Cable Loss and Velocity Factor values from a Cable file. See “How to Edit, Save, and Recall a Cable File” below. This will overwrite a manually-entered value.
 - **Man** (Default setting) Manually enter a value for Cable Loss and Velocity Factor.
- Then:
 - **Velocity Factor** Using the numeric keypad, enter a value between 0.01 and 1. Then press **Enter**.
 - **Cable Loss** Using the numeric keypad, enter a positive Cable Loss value in dB/m, then press **Enter**.

How to Edit a Cable File

The FieldFox includes many predefined cable files with the manufacturer’s specifications. You can edit these files or create new cable files using the following procedure or using the FieldFox Data Link Software.

The Cable correction data survives a Mode Preset and Preset.

With a TDR measurement present:

- Press **Meas Setup 4**
- Then **DTF Cable Specifications**
- Then **Edit/Save/Recall Cables**
- Press **New Cable** then **Yes** to clear all data from the existing DTF Cable table and reset header information to default settings.
- Then **Edit Cable** to open the Cable Editor.
- Then use the **▲▼** arrows to select a field,
 - When editing Cable Description information, press **Edit** then modify the selected field using the FieldFox labeler.
 - When editing Frequency/Loss pairs, enter numbers using the numeric keypad, then select a frequency suffix. Then **Enter**. Learn more about “How the Freq/Loss pairs are applied” below.
- Optionally choose from the following:
 - **Previous / Next Page** Quickly scrolls through pages of Freq/Loss data.
 - **Add Data** Add a blank Freq/Loss pair to the table,
 - **Delete/Clear** then:
 - **Delete Row** Remove the selected Freq/Loss pair from the table.

- **Clear All** then **Yes**. Remove all Freq/Loss pairs from the table and resets header information
- Press Done to close the Cable Editor.

How to Save or Recall a Cable

- Press **Save Cable** to save your changes to the specified Storage Device. Enter a filename using the FieldFox labeler (see **“How to use the FieldFox labeler ” on page 500**. Learn more about Cable files below
- Press **Recall Cable** to load a Cable file from the specified Storage Device
- **Storage Device** Changes the device used to save or recall Cable files. This is a different setting from the Save/Recall Storage Device setting. Choose from Internal (default setting), **USB** (must be connected) or **SD card**.

About Cable files

- Cable files are saved to, and recalled from, the **Cables** folder. If the folder does not already exist on a USB or SD card, it is created automatically before storing the file.
- Cable files are stored as *.xml files. Existing cable files that are preloaded into the FieldFox firmware can be overwritten. Your edited file will NOT be overwritten when firmware is updated.
- To **DELETE** a Cable file, use the Manage Files feature. Learn more in **“Manage Files” on page 506**.

How the Freq/Loss pairs are applied

When the cable file contains one Freq/Loss pair, that correction value is applied to the entire displayed frequency span.

When the cable file contains two or more Freq/Loss pairs, the Loss value that is used is interpolated from the Freq/Loss pairs and the TDR center frequency. For example, using a cable file with the following Freq/Loss pairs:

1 GHz: 0.1 dB/m

2 GHz: 0.2 dB/m

The center frequency for the measurement is determined from the calculated (Stop – Start) frequency values (seen on the second page of TDR Settings):

Calculated Start = 2.0 MHz

Calculated Stop = 3.598 GHz

Center Freq = 1.80 GHz

The Loss value for the measurement is interpolated from the Freq/Loss pairs at the Center Freq:

1 GHz = 0.1 dB/m

1.8 GHz = 0.18 dB/m

2 GHz = 0.2 dB/m

The correction for loss at 5 meters in one direction: $0.18 \text{ dB/m} * 5\text{m} = 0.9 \text{ dB}$.

All TDR measurements correct for loss for travel down the DUT and back, so double the correction: $0.9 \text{ dB} * 2 = 1.8 \text{ dB}$.

Window Settings

Window settings provide the ability to choose between optimizing TDR measurements for resolving closely-spaced faults or for the ability to measure low-level faults.

How to select Window settings

- Press **Meas Setup 4**.
- Then **Settings**.
- Then press **▲▼** arrows to move to the Window row.
- Then press **Edit**.
- Then press **Window** and choose from the following:
 - **Maximum (Maximum – Optimized for dynamic range)** the noise floor is lowered to provide the ability to measure low-level responses. (Default setting)
 - **Medium** – Compromise between Min and Max window settings.
 - **Minimum** – Best Response Resolution, providing the ability to resolve between two closely-spaced responses.
- Then press **Done Edit**.
- Again press **Done**.

Network Analyzer Windows Frequency Span and TDR Window Selection for Step Rise Time (Approximated)

The following table shows the approximated relationship between the frequency span and the window selection for impulse width and step rise time. Refer to [Figure 5-1 on page 79](#).

Window	Low-pass step (10% to 90%)	Low-pass impulse	Bandpass impulse
Minimum	0.45 / f span	0.60 / f span	1.20 / f span
Medium	0.99 / f span	0.98 / f span	1.95 / f span
Maximum	1.48 / f span	1.39 / f span	2.77 / f span

Figure 5-1 Network Analyzer TDR Rise Time

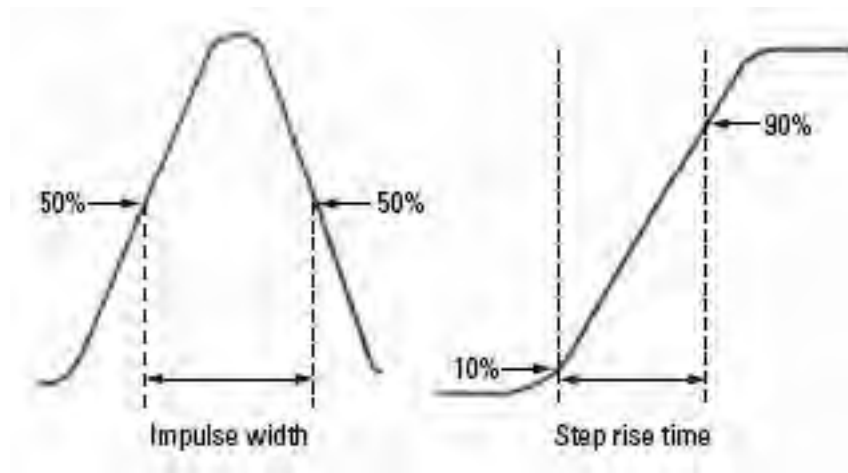

TDR Units

By default, X-axis units for TDR measurement settings are displayed in Meters.

How to change TDR units

- With a TDR measurement present, press **Freq/Dist.**
- Then **More** then **Distance Unit m feet.**
- The current selection is underlined **m (meters) Feet.**

The TDR Units setting is also available on the TDR Settings table.

Calculated TDR values

Press **Next Page** on the TDR Settings Table to view the following **calculated Values** noted on the FieldFox screen with c - <setting>

Start Frequency – Start frequency that is used to calculate TDR.

Stop Frequency – Stop frequency that is used to calculate TDR.

Range Resolution. Indicates the accuracy of the distance to fault measurement. For example, with range resolution of 500 mm, if the distance to fault is 10 meters, this value could be inaccurate by +/- 500 mm or between 9.5 to 10.5 meters. This value is calculated from frequency span / resolution (points).

Response Resolution, not displayed, indicates the distance that could be between two faults and still show as separate faults. Learn more in Window Settings in **“Window Settings” on page 78.**

Maximum Distance. The distance that could be viewed with the current settings. Defined by: $V_f * c * \text{Points} / (2 * \text{Bandwidth})$ where:

- V_f = velocity factor
- c = speed of light
- Points = resolution
- Bandwidth = frequency range

Alias-free Range (On/Off)

- On = No Alias images
- Off = Alias images may appear in the response.

About Alias Faults

An alias fault is not a true device response. An alias fault appears because of the method used to convert frequency to time.

On the TDR Settings page (above) the **c - Alias-free Range = Off** setting indicates alias images MAY appear on the screen.

Shorter stop distances (less than 10 meters) and a higher resolution (1001 points) will be more likely to result in **Alias-free Range = Off.**

When the Alias-free Range = Off, the following procedure will help to determine if a response is true or an alias response:

- 1. Put a marker on the response in question and note the distance to the fault.**
- 2. Change the start or stop distance.**

A true fault response will not move in distance. That is, if a true fault is present at 10.3 meters, changing the stop distance from 15 m to 20 m will not move the fault; the fault will remain at 10.3 meters. However, an alias response will appear to move.

An un-terminated cable (with NO perfect load at the end) will show faults that appear to be beyond the end of the cable. These are NOT alias faults. These faults appear as the signal reflects off the open at the end of the cable and travels back down the cable toward the connection at the FieldFox. Re-reflections are measured at the FieldFox as mirror images of the original faults. The largest fault is the open end of the cable. To avoid confusion, set the Stop distance shortly after that fault.

How to Prevent Undersampling

Undersampling is when the TDR measurement is inaccurate because the frequency step size (resolution) is too large. The predominant symptom of this is when the measured impedance is incorrect. For example, when measuring a 75Ω cable, a marker that is on a part of the trace without reflections shows 56Ω.

To prevent undersampling, set **TDR Sweep** to **Cable**. If undersampling still occurs, set **TDR Sweep** to **Auto**. Then set **Auto Max Frequency** to a lower value. Manually increase the Resolution so that the Start Frequency setting is less than about 500 kHz.

TDR (Time Domain Reflectometry) - Option 215
TDR Measurement Settings

6 NA (Network Analyzer) Mode

Learn more about NA Mode measurements in the FieldFox Supplemental Online Help:

<http://na.support.keysight.com/fieldfox/help/SupHelp/FieldFox.htm>.

In this Chapter

- “About S-parameters” on page 85
- “Mixed-Mode S-Parameters” on page 86
- “Parameter Conversion” on page 87
- “Receiver Measurements” on page 88
- “Multi-Trace Configurations” on page 89
- “Quick Settings” on page 90
- “Calibration Settings” on page 91
- “Format” on page 92
- “Frequency Range” on page 93
- “Scale Settings” on page 93
- “Magnitude Offset” on page 94
- “Electrical Delay” on page 95
- “Phase Offset” on page 95
- “Averaging” on page 96
- “IF Bandwidth” on page 97
- “Smoothing” on page 97
- “Single or Continuous Measure” on page 98
- “Resolution (Number of Data Points)” on page 98
- “Sweep Time” on page 99
- “Output Power” on page 100
- “System Impedance (Z0)” on page 101

“Port Extensions” on page 101

“Velocity Factor” on page 102

“Increase Dynamic Range” on page 105

See Also

“Why and When to Calibrate” on page 120

“All about Markers” on page 438

“All about Limit Lines” on page 453

“All about Trace Math” on page 458

Learn how to make 75Ω (ohm) Measurements in the Supplemental Online Help:

<http://na.support.keysight.com/fieldfox/help/SupHelp/FieldFox.htm>

NA Mode Settings

Select NA Mode before making any setting in this chapter.

How to select NA Mode

- Press **Mode**.
- Then **NA**.

About S-parameters

S-parameters (scattering parameters) are used to describe the way a device modifies a signal. The FieldFox can measure **four S-parameters**. The syntax for each parameter is described by the following:

S (out | in)

out = FieldFox receiver port

in = FieldFox source port

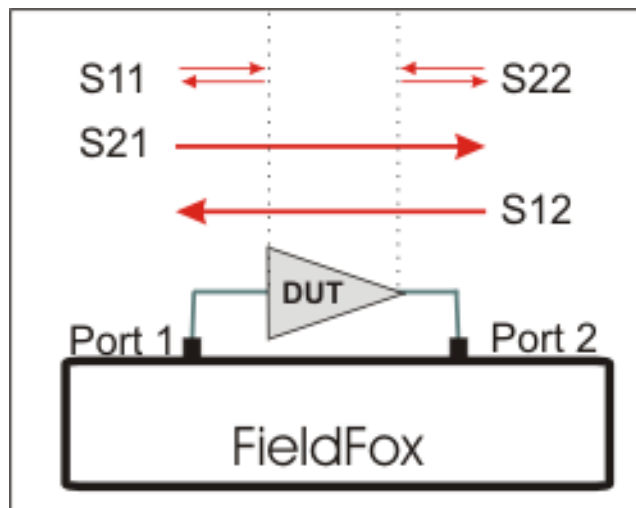

The FieldFox automatically switches the internal source and receivers to make both forward and reverse measurements. Therefore, the FieldFox can measure all four S-parameters with a single connection

When the source comes from port 1, the measurement is said to be in the forward direction

When the source comes from port 2, the measurement is said to be in the reverse direction

S11 and S22 reflection measurements are used to measure the amount of reflections off the corresponding DUT port. Low reflections means there is a good impedance match between the source and DUT.

S21 and S12 transmission measurements are used to measure the loss or gain through a DUT over a specified frequency range. Both ends of the DUT must be connected to the FieldFox. The FieldFox signal source is transmitted out one of the test port connectors, through the DUT, and into the other test port connector

How to measure S-parameters

1. Press **Preset** then **Mode Preset (Factory)**
 2. Press **Measure 1** then choose from the following:
 - **S11** Reflection measurement at port 1.
 - **S21** Forward 2-port transmission measurement.
 - **S12** Reverse 2-port transmission measurement. May require an option.
 - **S22** Reflection measurement at port 2. May require an option.
- OR** select a multi-trace configuration. Learn more on [“Multi-Trace Configurations” on page 89](#)
3. Press **Freq/Dist** then either **Start** and **Stop** or **Center** and **Span** to enter a Frequency Range for the measurement.
 4. Press **BW 2** then **IFBW** to select the IF Bandwidth for the measurement. Narrower bandwidths require more time to sweep, but lowers trace noise.
 5. Press **Sweep 3** then **Resolution** to select the number of data points for the measurement. More data points require more time to sweep.
 6. Press **Cal 5** to calibrate the measurement. Learn more in [“How to Perform a Calibration” on page 121](#).
 7. All other settings can be made AFTER calibration without compromising measurement accuracy.

Mixed-Mode S-Parameters

In NA Mode ONLY, mixed-mode S-parameters (also known as Balanced measurements) are available with Option 212.

Because the FieldFox has only two test ports, only reflection measurements are available. Connect the balanced input or output of your DUT to the FieldFox ports 1 and 2

For highest accuracy, a Full 2-port calibration is required.

All FieldFox settings and features are supported (except Parameter Conversion) with mixed-mode S-parameters.

NOTE

Learn more about Balanced Measurements with the FieldFox in the FieldFox Supplemental Online Help:

<http://na.support.keysight.com/fieldfox/help/SupHelp/FieldFox.htm>

How to make mixed-mode S-parameter measurements

- Press **Measure 1**.
- Then **More**.
- Then choose from the following:
 - **Sc11** Common reflect/common incident for logical port 1.
 - **Sdd11** Differential reflect/differential incident for logical port 1.
 - **Sdc11** Differential reflect/common incident for logical port 1.
 - **Scd11** Common reflect/differential incident for logical port 1.

To make balanced reflection measurements at the DUT output, connect the DUT output to the FieldFox ports.

Parameter Conversion

In NA Mode ONLY, converts the active S-parameter trace to an equivalent impedance (Z), admittance (Y), or reciprocal 1/S-parameter

How to select parameter conversions

- Press **Measure 1**
- Then select an S-parameter
- Then **More**
- Then **Conversion**
- Then choose from the following:
 - **Off** (default) No conversion is performed.
 - **Z Conv (--)** or **Y Conv (--)** Perform conversion for impedance (Z) or admittance (Y). Then choose from the following for either:
 - **Auto** The displayed S-parameter is converted to the appropriate Z or Y parameter: Refl for S11 and S22; Trans for S21 and S12. When the S-parameter is changed, the appropriate conversion changes automatically.
 - **Refl** The displayed S-parameter is converted to Z or Y reflection, regardless of whether the S-parameter is reflection (S11 or S22) or transmission (S21 or S12).

- **Trans** The displayed S-parameter is converted to Z or Y transmission, regardless of whether the S-parameter is reflection (S11 or S22) or transmission (S21 or S12).
- **1/S** The displayed S-parameter is converted to 1/S-parameter.

Receiver Measurements

In NA Mode ONLY, you can make unratioed, uncorrected receiver measurements. These measurements are typically used as diagnostic tools for service personnel.

NOTE

Receiver measurements are NOT corrected for absolute power. They are only useful for making relative measurements. The Y-Axis and markers are labeled in dB - NOT dBm. Specifically, R1 and R2, do NOT indicate the actual power levels out of the source ports.

How to make receiver measurements

- Press **Measure 1**
- Then **More**, then **Advanced**
- Then choose from the following:

A Port-1 test port (*1)

B Port-2 test port (*2)

R1 Port-1 reference receiver (*1)

R2 Port-2 reference receiver (*2)

(*) indicates the Auto-selected source port for the measurement

Source Port The FieldFox port to provide the source signal. Choose from the following:

- **Auto** The FieldFox sets the source port based on the selected receiver.
- **Port 1** Select when measuring transmission at B receiver.
- **Port 2** Select when measuring reverse transmission at A receiver.

Learn more about Raw Receiver Measurements at the FieldFox Supplemental Online Help:

<http://na.support.keysight.com/fieldfox/help/SupHelp/FieldFox.htm>

Multi-Trace Configurations

In NA Mode you can display multiple traces on the FieldFox screen.

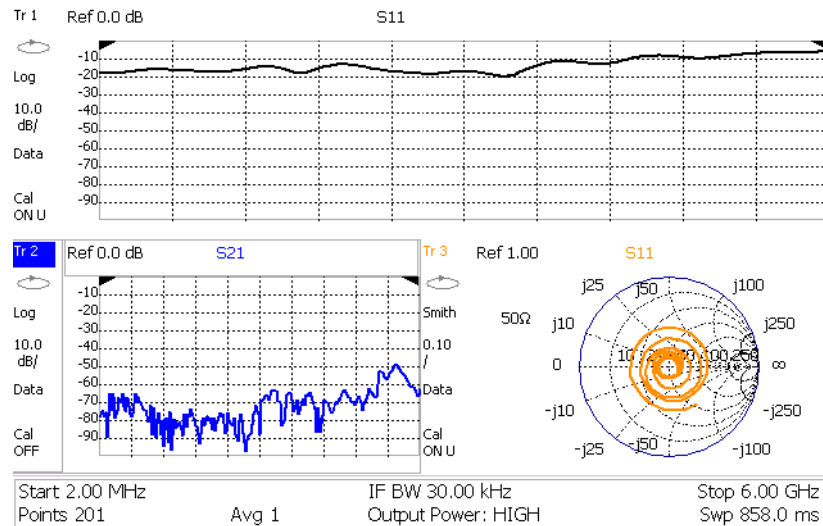

The graphic above shows a x3H configuration. Tr2 is the ACTIVE trace as indicated by the highlighted **Tr2**.

Trace Setting Notes

- The Frequency Range, IF BW, Resolution, Average, and Output Power settings are common for all displayed traces.
- All other trace settings, such as measurement, format, and limit lines, are applied individually to the ACTIVE trace in the same manner as when a single trace is present.







NOTE

IMPORTANT! For CAT and NA modes, limit lines do not apply where $F1 = F2$.

- By default, a marker is created on ALL traces. However, they can be created individually by disabling Coupled Markers. Learn more in [“Coupled Markers \(NA Mode\)” on page 441](#).

How to select a multi-trace configuration

- Press **Trace 6**
- Then **Num of Traces**
- Then choose from the following:
The default measurements depend on the options that are installed

	x1	1 trace standard configuration
<hr/>		
	x2	2 traces overlaid on a single graticule
<hr/>		
	x2H	2 traces on separate graticules
<hr/>		
	x3H	3 traces on separate graticules
<hr/>		
	x3	3 traces overlaid on a single graticule
<hr/>		
	x4H	4 traces on separate graticules

How to activate a trace in order to change a setting

- Use the  arrows **OR**
- Press **Trace 6** then select **Trace 1**, **Trace 2**, **Trace 3**, or **Trace 4**. Only traces that are shown can be activated.

How to maximize the viewing of the active trace

- Press **System 7**
- Then **Full Screen**.
- Press any key to return to the standard display.

Quick Settings

Both CAT and NA Modes allow you to view and change most relevant settings from a single location. All of these settings are discussed in this chapter and, unless otherwise noted, ALL of these settings can also be made using the standard softkey menus.

How to view and change Quick Settings

- Press **Meas Setup 4**

- Then **Settings**.
 - Press **Next Page** and **Previous Page** to view all settings. If these softkeys are NOT available, then all available settings fit on one page.
 - To change a setting:
 - Use the **▲▼** arrows to highlight a setting.
 - Then press **Edit**. The current setting changes to **yellow**.
 - Some settings require you to press a softkey to change the value.
Otherwise, use the numeric keypad, **▲▼** arrows, or rotary knob to change the value.
 - When finished changing a value, press **Done Edit**.
 - Press **Dock Window** to relocate the Settings table to a position relative to the trace window. The Dock Window setting persists through a Preset. Choose from the following:
 - **Full (Default setting)** Only the Settings table is shown on the screen. The trace window is temporarily not shown.
 - **Left** The Settings table is shown to the left of the trace window.
 - **Bottom** The Settings table is shown below the trace window.
- When finished changing ALL settings, press **Done** to save your settings.

Calibration Settings

NA Mode has a page specifically for making settings that pertain to Port Extensions, including Velocity Factor and Media Type.

Learn more in **“Port Extensions” on page 101**.

Learn more about Media Type in **“Waveguide Calibrations” on page 135**.

How to view and change Calibration Settings

- Press **Meas Setup 4**.
- Then **Calibration Settings**
- Make these settings in the same manner as Quick Settings in the previous section.

Format

Select the display format in which to present measurement results. This setting can be changed at any time without affecting calibration accuracy.

NOTE

Learn more about Display Formats in the FieldFox Supplemental Online Help:

<http://na.support.keysight.com/fieldfox/help/SupHelp/FieldFox.htm>

The marker on screen readout can be changed to formats other than the display format. Learn more in “[Marker Format](#)” on page 443.

How to select a NA Format

- Press **Measure 1**.
- Then **Format [current setting]**.
- Then choose from the following:
 - **Log Magnitude** Displays magnitude in dB
 - **Linear** Displays positive values only. Y-axis: Unitless (U) for ratioed measurements; Watts (W) for unratioed measurements.
 - **VSWR** Used mainly for S11 and S22. Displays unitless reflection data.
 - **Phase** Displays phase in degrees. The trace ‘wraps’ every 360 degrees, from +180 to –180, for easy scaling.
 - **Smith** Used mainly for S11 and S22, which are plotted on a Smith Chart. Displays series resistance and reactance.
 - **More** then...
 - **Polar** Used mainly for S11 and S22. Displays magnitude and phase of the reflection coefficient.
 - **Group Delay** Used mainly for S21 and S12. Displays signal transmission (propagation) time through a device in seconds. The Group Delay aperture is the current Smoothing aperture. Default is 1.5% of the X-axis.
 - Learn how to set Smoothing aperture on “[Smoothing](#)” on page 97.
 - Learn more about Group Delay measurements at the FieldFox Supplemental Online Help:
<http://na.support.keysight.com/fieldfox/help/SupHelp/FieldFox.htm>
 - **Real** Displays only the real (resistive) portion of the measured complex data. The Y-axis is Unitless. Often used for Time Domain measurements.

- **Imaginary** Displays only the reactive portion of the measured complex data. The Y-axis is Unitless.
- **Z Magnitude** Displays the effective impedance in ohms.
- **Unwrap Phase** Same as Phase, but without 180 degree wrapping.

NOTE

Phase is unwrapped by comparing the phase from one data point to the next. If the phase difference between two data points is greater than 180 degrees, or if the phase of the first data point is greater than 180 degrees from DC, then the phase measurement is probably NOT accurate. To ensure that the phase measurement is accurate, increase the resolution setting. When making a narrow band measurement, reduce the start frequency for the unwrapped phase measurement to ensure the first data point is less than 180 degrees from DC.

Frequency Range

Set the range of frequencies over which you would like to make measurements.

When the frequency range is changed after a calibration is performed, the cal becomes interpolated. Learn more in [“Interpolation *” on page 138](#).

How to set Frequency Range

This can be done in two ways:

- Press **Freq/Dist**
- Then choose from the following:
 - **Start** and **Stop** frequencies – Specify the beginning and end of the sweep.
 - **Center** and **Span** frequencies – Specify the center frequency and span of frequencies (half on either side of center).
- Follow each by entering a value using the numeric keypad, the **▲▼** arrows, or the rotary knob.
- After using the **▲▼** arrows or the rotary knob, press **Enter**. The increment setting of the arrows is based on the current span and can NOT be changed in NA Mode.
- After using the keypad, select a multiplier key. Learn more in [“Multiplier Abbreviations” on page 41](#).

Scale Settings

Adjust the Y-axis scale to see the relevant portions of the data trace. The Y-axis is divided into 10 graticules.

This setting can be changed at any time without affecting calibration accuracy.

How to set Scale

- Press **Scale / Amptd**.
- Then choose from the following method
 - **Autoscale** Automatically adjusts the Y-axis to comfortably fit the Minimum and Maximum amplitude of the trace on the screen.
 - **Autoscale All** Autoscales all of the traces on the screen, useful only for multi-trace configurations.
- 3. Set Scale, acquisition, and Reference Position
 - **Scale** Manually enter a scale per division to view specific areas of the trace.
 - **Ref Level** Manually set the value of the reference line. Enter a negative value by pressing **Run/Hold (+/-)** either before or after typing a value.
 - **Ref Pos** Manually set the position of the reference line. Values must be between 0 (TOP line) and 10 (BOTTOM line)

Scale annotation on the FieldFox screen

- Reference Line = red arrow
- Ref Level = -40 dB
- Ref Position = 1
- Scale = 2 dB per division

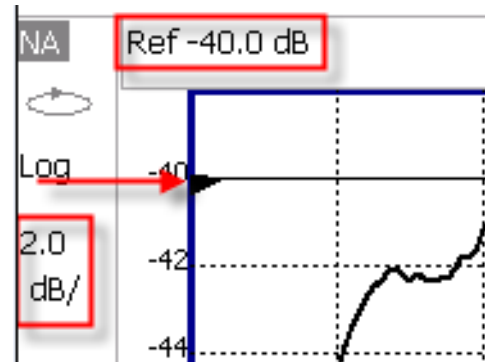

Magnitude Offset

Magnitude Offset allows you to offset the magnitude (not phase) data by a fixed and/ or sloped value in dB. If the display format is Linear Magnitude or Real (unitless), the conversion from dB is performed and the correct amount of offset is implemented.

The Magnitude offset setting affects only the active trace.

How to set Magnitude Offset

- Press **Scale / Amptd**
- Then **More**
- Then **Magnitude Offset** - Offsets the entire data trace by the specified value.

- Then enter a positive or negative offset value in dB using the numeric keypad, the **▲▼** arrows, or the rotary knob. Press a multiplier key. Learn about multiplier abbreviations.
- And/or press **Slope** - Offsets the data trace by a value that changes linearly with frequency. The offset slope begins at 0 Hz. and continues to the stop frequency. The offset value at the start frequency is then calculated from 0 Hz.
- Then enter a positive or negative offset slope value in dB/GHz using the numeric keypad, the **▲▼** arrows, or the rotary knob. Press a multiplier key. Learn about multiplier abbreviations in **“Multiplier Abbreviations” on page 41.**

Electrical Delay

Electrical delay is a mathematical function that simulates a variable length of lossless transmission line. Use the electrical delay feature to compensate for the linear phase shift through a device and view only the deviation from linear phase of the device.

You can set the electrical delay independently for each measurement trace. To apply an electrical delay to all measurement traces, use Port Extensions. Learn how in **“Port Extensions” on page 101.**

Learn how to set Phase formats in **“Phase Offset” on page 95.**

How to set Electrical Delay

- Press **Scale / Amptd**
- Then **More**
- Then **Electrical Delay**
- Enter a time value using the numeric keypad, the **▲▼** arrows, or the rotary knob.
- Press a multiplier key. Learn about multiplier abbreviations in **“Multiplier Abbreviations” on page 41.**

Electrical Delay can also be set using the **Mkr->Delay** feature. Learn how on **“Marker Functions” on page 451.**

Phase Offset

Phase offset mathematically adjusts the phase measurement by a specified amount, up to 360°. Use this feature in the following ways:

Improve the display of a phase measurement. This is similar to the way you would change the acquisition in an amplitude measurement. Change the phase response to center or the response on the screen.

Emulate a projected phase shift in your measurement. For example, if you know that you need to add a cable and that the length of that cable will add a certain phase shift to your measurement, you can use phase offset to add that amount and simulate the complete device measurement.

You can set the phase offset independently for each measurement trace.

How to set Phase Offset

- Press **Scale / Amptd**
- Then **More**
- Then **Phase Offset**
- Enter a value in degrees using the numeric keypad, the **▲▼** arrows, or the rotary knob. Press **Enter**

Averaging

Averaging helps to reduce the effects of random noise on a measurement. You specify the number of measurements to be averaged. The more measurements averaged, the greater the amount of noise reduction. An average counter is shown in the left edge of the screen as Avg <n> where <n> is the number of measurements that are averaged.

Averaging can be set before or after calibration. When set before calibration, each calibration standard is measured <n> times and averaged. More time is needed to perform the calibration, but there will be less noise in the resulting error terms which means that subsequent measurements will also have less noise. In addition, noise is further reduced by continuing to average after calibration.

How to set Averaging

- Press **BW 2**.
- Then **Average <n>** where <n> is the number of measurements to average.
- Enter a value using the numeric keypad. Enter 1 for NO averaging.
- Press **Enter**.
- Then **Average Mode** Choose from the following:
 - **Sweep** - Each data point is based on the average of the same data point being measured over <n> consecutive sweeps. The average counter shows the number of previous sweeps that have been averaged together to form the current trace. When the counter reaches the specified count, then a 'running average' of the last <n> sweeps is displayed.

- **Point** - Each data point is measured <n> times and averaged before going to the next data point. On subsequent sweeps, averaging restarts by measuring each data point again <n> times. The average counter is not updated because data is not displayed until all the averages have been applied.
- **Point averaging is usually faster than sweep averaging.** However, you may need to increase the Point Average count to obtain the same level of noise reduction as with sweep averaging.
- While averaging is in process, press **Sweep 3** then **Restart** to restart the averaging at 1.

IF Bandwidth

The FieldFox converts the received signal from its source to a lower intermediate frequency (IF). The bandwidth of the IF bandpass filter is adjustable. Reducing the IF receiver bandwidth reduces the effect of random noise on a measurement. However, narrower IF bandwidths cause longer sweep times.

How to set IF BW

- **Press BW 2.**
- Then **IF BW**
- Then choose from the following:
- **10 Hz | 100 Hz | 1 kHz | 10 kHz | 100 kHz**
More 30 Hz | 300 Hz | 3 kHz | 30 kHz

Smoothing

Trace smoothing averages a number of **adjacent** data points to smooth the peak-to-peak noise values on a displayed trace. The number of adjacent data points that are averaged is known as the smoothing aperture. Aperture is set by specifying a percentage of the X-axis span.

Trace smoothing does NOT significantly increase measurement time.

Smoothing is used in Group Delay measurements, although it can be used with any NA format EXCEPT Polar or Smith Chart. Learn more about NA Mode formats, including Group Delay, in **“Format” on page 92**.

When enabled, **Smo** appears on the FieldFox screen.

How to set Smoothing

- **Press BW 2**
- Then **Smoothing ON OFF**
- Then **Sm. Aperture** and enter a value between 0 and 25 (percent) using the numeric keypad.

- Press **Enter**

Single or Continuous Measure

This setting determines whether the FieldFox sweeps continuously or only once each time the **Single** button is pressed. Use Single to conserve battery power or to allow you to save or analyze a specific measurement trace.

This setting can be changed at any time without affecting calibration accuracy.

How to set Single or Continuous

- Press **Sweep 3**.
- Then choose one of the following:
 - **Single** Automatically sets Continuous OFF and causes FieldFox to make ONE sweep, then hold for the next Single key press. Hold is annotated in the upper left corner of the display when NOT sweeping, and changes to an arrow --> while the sweep occurs.
 - **Continuous** Makes continuous sweeps. This is the typical setting when battery power is not critical.
- You can also use **Run / Hold +/-** to toggle between Single and Continuous.

Resolution (Number of Data Points)

Data points are individual measurements that are made and plotted across the X-axis to form a trace. Select more data points to increase measurement resolution. However, more data points also takes more time to complete an entire measurement sweep.

When the Resolution is changed after a calibration is performed, the cal becomes interpolated. Learn more in **“Interpolation *” on page 138**.

How to set Resolution

- Press **Sweep 3**.
- Then **Resolution**.
- Then choose from the following:
101 | **201** | **401** | **601** | **801** | **1001** | **1601** | **4001** | **10001**.
- Using SCPI, Resolution can be set to ANY number of points between 3 and 10001. See the Programming Guide at <http://na.support.keysight.com/fieldfox/help/Programming/webhelp/FFPprogrammingHelp.htm>

Sweep Time

The fastest possible sweep time is always used as the default setting. Use the Min Swp Time setting to slow the sweep time when measuring long lengths of cable. Learn more at the FieldFox Supplemental Online Help:

<http://na.support.keysight.com/fieldfox/help/SupHelp/FieldFox.htm>

The actual sweep time is shown on the FieldFox screen. See the Screen Tour on “[Screen Tour](#)” on [page 39](#). To increase the sweep time, enter a value that is higher than the actual sweep time. The increase will not be exactly the amount that you enter, as the actual sweep time is the composite of many factors.

NOTE

Measurement speed specifications do NOT apply in Temperature Control Mode. Learn more in “[Temperature Control Mode](#)” on [page 29](#).

How to set Sweep Time

- Press **Sweep 3**.
- Then **Min Swp Time**.
- Enter a value using the numeric keypad.
- Press a multiplier key. Learn about multiplier abbreviations in “[Multiplier Abbreviations](#)” on [page 41](#).

Triggering

External triggering (NA and SA modes ONLY) allows you to initiate a sweep when an external DC voltage is sensed at the Ref In/Trig In connector on the FieldFox top panel. See External Triggering for SA Mode in “[Triggering](#)” on [page 169](#).

Trigger Source

- Press **Sweep 3**
- Then **Trigger**
- Then **Trig Source**
- Then choose from the following:
 - **Internal** Sweeps are initiated by the FieldFox internal circuitry. When Sweep is set to Continuous, a new sweep begins automatically when the previous sweep ends.
 - **External** A sweep is initiated on the rising or falling edge of an external TTL signal at the Ref In/Trig In connector on the FieldFox top panel.
 - When the FieldFox is armed for an external trigger signal, **Wait** is annotated on the display.
 - A sweep can NOT be initiated by an external signal while a sweep is in progress.

—A sweep can NOT be initiated by an external signal when in HOLD mode. Learn more about HOLD mode in.

Trigger Slope

Determines which edge of an External trigger signal initiates a sweep.

- Press **Sweep 3**
- Then **Trigger**
- Then **Trig Slope**
- Then choose from the following:
 - **Positive** Sweep is initiated by the rising edge of signal at about 1.7 V.
 - **Negative** Sweep is initiated by the falling edge of signal at about 1.0 V.

Output Power

Set the power level out of the FieldFox to High, Low, or manually set power level to a value between High and Low.

Generally, the high power setting is used when measuring passive, high-loss devices to place the signal farther from the noise floor. However, for devices that are sensitive to high power levels such as amplifiers, use the Low power setting.

For best measurement accuracy, use the Manual power setting at -15 dBm. After calibration, the power level can be decreased for amplifiers, or increased for higher dynamic range.

CAUTION

Power Level settings in this mode will NOT change Power Level settings in other modes. To help prevent damage to your DUT, use caution when changing modes with your DUT connected to the FieldFox test ports.

How to set Output Power

- Press **Meas Setup 4**.
- Then **Output Power**
 - **High** Sets output power to the maximum achievable power at all displayed frequencies. Output power is NOT FLAT across the displayed FieldFox frequency span. Please see **“Specifications/Data Sheet” on page 541** for expected power levels.
 - **Low** Sets output power to approximately -45 dBm, FLAT across the displayed FieldFox frequency span.

- **Man** (default setting at -15 dBm) Set output power to an arbitrary value, FLAT across the displayed FieldFox frequency span. If flattened power can NOT be achieved, a warning message and beep occurs. To achieve a flattened output power, reduce the power level or stop frequency.
- Then press **Power Level**.
- Then enter a value using the numeric keypad, the **▲▼** arrows, or the rotary knob.
- Press **Enter**.

System Impedance (Z0)

To accurately view data presented in Smith Chart format, first set the System Impedance.

Learn how to select Smith Chart format in **“Format” on page 92**.

Learn how to make 75Ω measurements at the FieldFox Supplemental Online Help: <http://na.support.keysight.com/fieldfox/help/SupHelp/FieldFox.htm>

How to set System Impedance

- Press **Meas Setup 4**.
- Then **Settings**.
- Then scroll to System **Z0** and press **Edit**.
- Then type either **50** or **75** and press **Enter**.

Port Extensions

Port extensions allow you to electrically move the calibration reference plane on either port 1 or port 2 after you have performed a calibration.

Why use Port Extensions

Use port extensions if you are unable to perform a calibration directly at your device because the location is not accessible. Perform a calibration at a convenient place, then use port extensions to compensate for the time delay (phase shift) to the desired reference plane. On the FieldFox, port extensions does not compensate for the loss of the additional electrical length, nor any mismatch errors beyond the calibration reference plane.

Also use port extensions if you have already performed a calibration, and then decide that you need to add a length of transmission line in the measurement configuration. Use port extensions to “tell” the FieldFox that you have added the length to a specific port.

- With S11 and S22 reflection measurements, the FieldFox doubles the port extension value that you enter to account for the additional delay in the forward and reverse directions.
- With S21 and S12 transmission measurements, the port 1 and port 2 extensions are added together. This accounts for the total transmission delay going through ports 1 and 2.

Port extensions and Electrical Delay differ in the following ways:

- Electrical delay applies to a specific trace
- Port extensions apply to specific hardware ports

Port Extensions and Electrical Delay can be set independently. When both are set, the delay adds together. Learn more about Electrical Delay in [“Electrical Delay” on page 95](#).

How to apply Port Extensions

- Press **Meas Setup 4**.
- Then **Port Extensions**
- Then **Port Extensions ON**
- Then **Port1 Extension**
- Then enter time value using the numeric keypad, the **▲▼** arrows, or the rotary knob. Press **Enter** or select a seconds (time) multiplier.

You can also set Port Extensions by pressing **Meas Setup 4** then **Calibration** (settings).

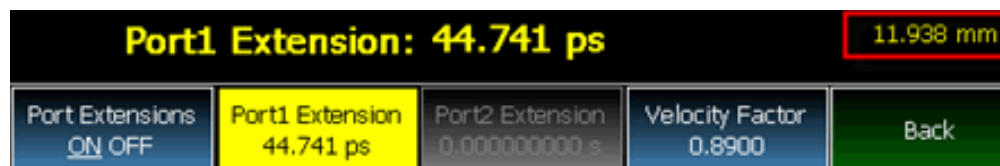

While setting Port Extension, the physical length of the extension, at the current Velocity Factor setting, is visible to the right (red box in above image).

Velocity Factor

The electrical delay or port extension value is entered as delay, or **electrical length**, in units of time.

Entering the velocity factor causes the FieldFox to accurately display the equivalent **physical length** in meters (NOT available in feet) that corresponds to the entered electrical delay.

Velocity factor is the ratio of the velocity of wave propagation in a coaxial cable to the velocity of wave propagation in free space. This velocity depends on the relative permittivity of the cable dielectric (ϵ_r).

$$\text{Velocity factor} = 1/\sqrt{\epsilon_r}$$

VF = 0.66 corresponds to wave propagation through a polyethylene dielectric.

VF = 1.0 (default setting) corresponds to wave propagation through free space (a vacuum).

How to set Velocity Factor

- Press **Meas Setup 4**.
- Then **Port Extensions**
- Then **Velocity Factor**
- Then enter a value between 0.1 and 1 using the numeric keypad, then press **Enter**.

You can also set Velocity Factor by pressing **Meas Setup 4** then **Calibration (settings)**.

Big Marker Display States (A and B)

This feature, available ONLY in NA Mode, allows you to view up to three Big or Super Big marker readouts. This is done by using up to two different display states called A and B. Each display state is comprised of the settings listed below. When the Big Readout setting is toggled through A and B, these display states are recalled.

How to create Big Marker Display States

To have big readouts, markers MUST be created using the following procedure.

If you have already set up your display and do not want to lose it, then save the current state to a state file. Learn how in **“State Files” on page 502**. The following procedure will overwrite your display state.

- Press **Mkr ->/ Tools**
- Then **Big Readout**
 - **A or B** - The A or B display state is recalled. If none have been defined, then the default display state is recalled.
 - **OFF** - The B display state is visible but without the Big Marker Readout.
- With A or B selected, then press **Edit Big Marker (A or B)**
- Then edit the following display state settings:
 - **Num Traces** – Choose the Multi-Trace configuration x1, x2, or x3. Only Overlaid configurations are allowed. Learn more in **“Multi-Trace Configurations” on page 89**.

- **Font Size** – Choose either Big or Super Big. Super Big marker readout #3 will cover some of the measurement grid.
- **Trace Settings** – For each possible trace (1, 2, and 3) select from the following:
 - **Measurement** – S-Parameter or Receiver measurement to display. **S11** is default. Learn more in [“About S-parameters” on page 85](#).
 - **Meas Format** – **Log** is default. Learn more in [“Format” on page 92](#).
 - **Bandwidth (ON)** – Marker readout for marker bandwidth search. OFF is default. Learn how to set BW parameters in [“How to Search with Markers” on page 444](#).
- **Big Readout** – For each marker readout (1, 2, and 3), select from the following:
 - **Marker #** – Enter a number from 1 to 6 to create the marker. 1 is created by default.
 - **Trace #** – The marker# is created on this trace. Tr1 is selected by default. The corresponding Num Traces must first be selected. For example, to create a marker on Trace 3, first select Num Traces = x3.
 - **Format** – Format for the marker readout. Select Default to make the marker readout format the same as the display format. Default is selected by default.
 - **Mkr Tracking** – ON: Select the parameter to track on the standard Marker Search menu. OFF is selected by default. When set to ON, Peak tracking is set by default. Learn about Marker Tracking in [“Marker Functions” on page 451](#).
 - **State** – Choose from Normal, Delta, or OFF. The default marker (1) is created in Normal. Learn more in [“Marker Functions” on page 451](#).
 - **Enabled** – Turns the Big Readout of the corresponding marker ON and OFF. The default marker (1) is set ON by default.

Notes:

- To move a marker, press **Marker**, then **Marker**, then scroll to the marker number to be moved. The new marker position can NOT be saved with the A or B display state.
- Settings that are NOT listed above are NOT affected by the recalled display states.
- Changes to the above settings outside the Big Readout menu will be overwritten when Big Readout (A or B) is selected. For example, suppose the display format for the B state is Log. If you change the display format to Lin using the standard menu (Meas 1, Format), the setting will show on the display. But if you then use the Big Readout (A | B | OFF) setting, when B is recalled, the Lin setting will be overwritten with the original Log setting.

Increase Dynamic Range

Dynamic range is the difference between maximum input power to the FieldFox receiver (without compressing the receiver), and the minimum measurable power (noise floor). Measurement accuracy is increased when the DUT response is at least 10 dB above the noise floor. For a measurement to be valid, input signals must be within these boundaries.

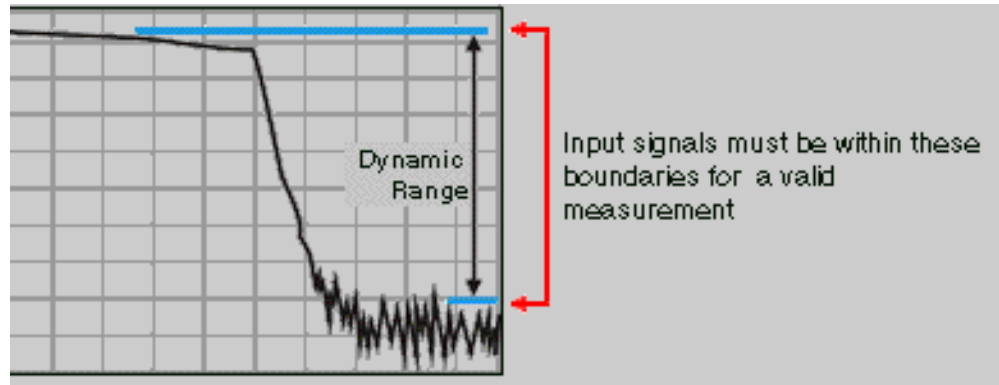

The following settings will increase the dynamic range of your NA mode measurement.

- Increase Power Level: Press **Meas 4** then **Output Power High**
- Lower the IFBW: Press **BW 2** then **IF BW**
- Increase Averaging: Press **BW 2** then **Average**

The following procedure MAY increase the dynamic range of your NA mode measurement. The results you see will depend on the performance of your DUT.

With an S21 trace active:

1. With RF OUT (port-2) open, press **Trace 6** then **Math and Memory** then **Data->Mem**
2. Re-connect the DUT.
3. Press **Data Math** then **Data-Mem**

NA (Network Analyzer) Mode
NA Mode Settings

7 Time Domain – Option 010

With NA Mode, Time Domain (Opt 010), frequency information is used to calculate and display measurements with time as the horizontal display axis. The response values appear separated in time allowing a different perspective of the test device's performance and limitations.

NA Mode settings that are NOT unique to Time Domain are documented in [Chapter 6, "NA \(Network Analyzer\) Mode", on page 83](#).

In This Chapter

["Overview" on page 109](#)

Time Domain (Transform) Settings

["Transform Settings Table" on page 110](#)

["Start/Stop \(Frequency Range\) and Points" on page 110](#)

["Stimulus \(Mode\)" on page 111](#)

["Set Frequency Lowpass" on page 111](#)

["Start/Stop Time" on page 111](#)

["Distance Units" on page 112](#)

["Window Layout" on page 112](#)

["Transform Window" on page 112](#)

["Line Loss and Velocity Factor" on page 113](#)

["Data Chain" on page 114](#)

["Gating Type" on page 117](#)

Trace Settings

["Transform Enable" on page 115](#)

["Gate Enable" on page 115](#)

Gating Settings

“Start, Stop, Center, and Span Gate Times” on
page 117

“Gating Type” on page 117

Overview

In normal NA Mode operation, the FieldFox measures the characteristics of a test device as a function of frequency. With Time Domain (opt 010), frequency information is used to calculate the inverse Fourier transform and display measurements with time on the horizontal display axis. The response values appear separated in time, allowing a different perspective of the test device's performance and limitations.

The graphic below compares the same cable reflection measurement data in both the frequency and time domain. The cable has two bends. Each bend creates a mismatch or change in the line impedance.

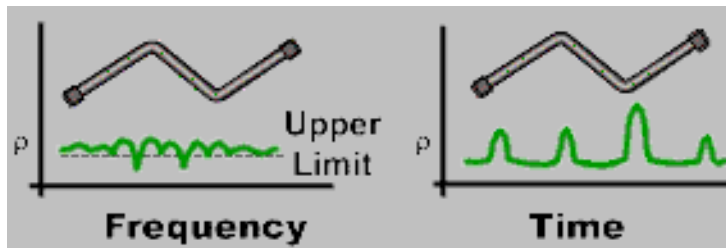

The frequency domain of an S11 measurement shows reflections caused by mismatches in the cable. It is impossible to determine where the mismatches physically occur in the cable.

The Time Domain response shows both the location and the magnitude of each mismatch. The responses indicate that the second cable bend is the location of a significant mismatch. This mismatch can be gated out, allowing you to view the frequency domain response as if the mismatch were not present. Learn more about gating in **“Gating” on page 116**.

Markers that are created on a Time Domain trace can be used to pinpoint the distance of the mismatch from the reference plane.

For more information on Time Domain theory, see <http://literature.cdn.keysight.com/litweb/pdf/5989-5723EN.pdf>

Time Domain (Transform) Settings

You can set and view most of the Time Domain settings on the Transform Settings table.

Transform Settings Table

The following settings (from Transform Stimulus Settings to Data Processing) are listed in the order they appear on the Transform Settings menu selection.

How to make settings on the Transform settings table

- Press **Meas Setup 4**.
- Then **Transform**
- Then **Transform Settings**.
- Press **Next Page** and **Previous Page** to view all settings.
- To change a setting:
 - Use the **▲▼** arrows or rotary knob to highlight a setting.
 - Numeric settings can be changed by pressing numbers using the numeric keypad. Then press Enter or select a suffix if available.
 - Some settings allow you to press **Edit** to toggle the value. Other settings require that you then press a softkey to change the value.
 - When finished changing a value, press **Done Edit**.
- Press **Dock Window** to relocate the Settings table to a position relative to the trace window. The Dock Window setting persists through a Preset. Choose from the following:
 - **Full (Default setting)** Only the Settings table is shown on the screen. The trace window is temporarily not shown.
 - **Left** The Settings table is shown to the left of the trace window.
 - **Bottom** The Settings table is shown below the trace window.
- When finished changing ALL settings, press **Done** to save your settings.

Start/Stop (Frequency Range) and Points

All Time Domain measurements are made in the frequency domain and, using Inverse Fourier Transform (IFT), time is calculated. Select the frequency range from which Time Domain measurements are calculated. Increasing the data points will improve measurement resolution. However, more data points will usually result in slower sweep updates.

Set frequency range and points before selecting Stimulus Mode.

Stimulus (Mode)

- There are three variations on how the Time Domain transform algorithm is applied to the frequency domain measurement. Each method has a unique application.
- **Lowpass Impulse** - Highest resolution. Most useful for seeing small responses in devices that pass low frequencies, such as cables.
- **Lowpass Step** - Easiest to identify inductive and capacitive discontinuities in devices that pass low frequencies such as cables.

In both Lowpass modes, frequencies down to DC and negative frequencies are extrapolated. Therefore, when either Lowpass mode is selected, Set Freq.Low Pass is automatically applied to adjust the start frequency. Learn more about Set Frequency Lowpass below.

When the Start Frequency or resolution is changed AFTER selecting a Lowpass mode, then Stimulus mode is set to Band Pass and Transform is disabled.

- **Bandpass Impulse**- Easiest method - can be used with any frequency sweep. Most useful for measuring band limited devices such as filters and DC blocked cables. This mode does NOT show capacitive and inductive reactance. For the same frequency span and number of points, band pass mode has twice the impulse width, which hides closely spaced responses degrading the response resolution.

Set Frequency Lowpass

NOTE

This setting is made automatically when either Lowpass mode is selected.

USE ONLY IN LOW PASS MODES. The Low Pass Start frequency is adjusted so that the Low Pass Stop frequency is at harmonics of the Low Pass Start frequency. Start frequency is computed by the following formula:

Low Pass Start Frequency = Stop Frequency / Number of points.

Start/Stop Time

The following settings adjust the **display resolution**, allowing you to zoom IN or OUT on a response. When the start or stop time is updated, they may be automatically adjusted to limit the display to one alias-free response on either side of zero time.

How to set Start and Stop time

- Press **Measure Setup 4**
- Then **Transform**
- Then **Transform Start Stop**

- Then choose from:
 - **Start** Sets the transform start time.
 - **Stop** Sets the transform stop time.

NOTE

Zero (0) seconds is always the calibration reference plane. Negative values are useful if moving the reference plane.

Distance Units

When markers are present on a Time Domain trace, marker X-axis values are shown both in units of time (seconds) and distance. Select the units in which the marker distance data is presented.

Distance Units are also used when setting Time Domain Line Loss. Learn more in. [“Distance Units” on page 112.](#)

Choose from: m (meters), or Feet.

Window Layout

This setting is used to create additional traces, or select a new layout for traces that are already created,

Choose from: x1, x2, x2H, x3H, x3, x4H.

Learn more about multi-trace configurations in [“Multi-Trace Configurations” on page 89.](#)

Transform Window

There are abrupt transitions in a frequency domain measurement at the start and stop frequencies, causing overshoot and ringing in a Time Domain response. The Window setting reduces the abruptness of the frequency domain transitions. This causes you to make a trade off in the Time Domain response.

The Window setting applies to ALL traces.

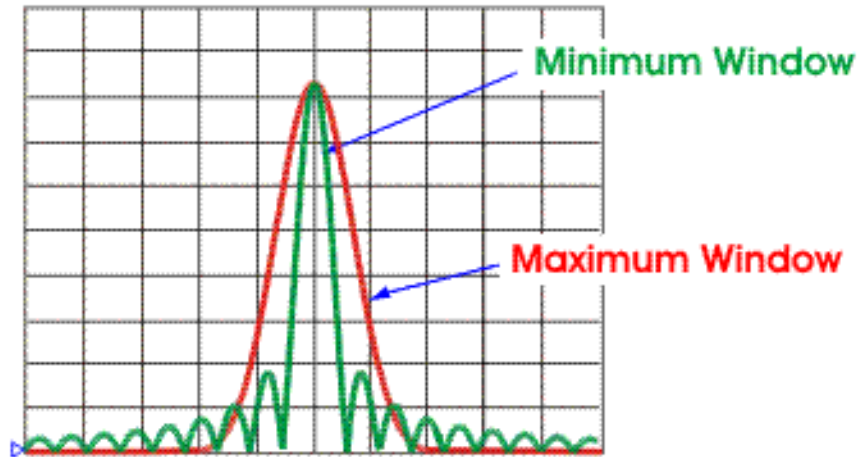

How to make Window setting

- Press **Measure Setup 4**
- Then **Transform**
- Then **More**
- Then **Transform Window**
- A settings table appears that allows you to navigate and select the following settings. These settings are made exactly like those made on the Transform Settings table. Learn how in [“Transform Settings Table” on page 110](#).

NOTE

Any of the following four methods can be used to make this same Window setting. Impulse Width values are calculated from the frequency span and Kaiser Beta value.

1. Window	Min	Medium	Max
2. Percent	0	50	100
3. Kaiser Beta	0	6.50	13.00
4. Impulse Width	100.455 ps	168.501	231.284

Line Loss and Velocity Factor

By default, the FieldFox does NOT correct Time Domain measurements to account for the inherent loss of a cable. However, to make more accurate measurements, Line Loss and Velocity Factor should be considered.

About Velocity Factor and Line Loss

- Velocity Factor is a property of the physical material of a cable. A VF of 1.0 corresponds to the speed of light in a vacuum, or the fastest VF possible. A polyethylene dielectric cable has VF = 0.66 and a cable with PTFE dielectric has VF = 0.7.
- Line Loss is specified in dB/m (or ft). In addition to the length of the cable, loss is also directly proportional to the frequency of the signal that passes through the cable.

The following is an example showing how Line Loss works:

The DUT is a 100 meter transmission cable. The Line Loss value is 1 dB/meter. This means that a signal traveling ONE WAY through the cable will lose 10 dB of power (100 m * 1dB/m). Because the FieldFox performs this measurement with 1 port, the test signal travels down the cable and then back, for a total loss of 20 dB.

For the purpose of illustrating this point, connect an OPEN to the end of the cable – a maximum-sized fault – for 100% reflection of the 300 MHz test signal.

Without compensation for the loss of the cable, a –20 dB response would be visible at 100 meters, which is the OPEN at the end of the DUT. This is from 10 dB of loss through the cable in each direction.

With compensation for the loss using the manufacturer's specification, the FieldFox compensates the trace as though the signal traveling through 100 meters was increased by +20 dB. Therefore the response will show 0 dB for 100% reflection.

Data Chain

This setting, available only on the Transform Settings Table, reverts to **Standard** when the FieldFox is Preset. Choose from the following:

- **Standard** – The normal FieldFox data processing chain. Transform calculations are performed AFTER error correction and trace math.
- **8510** – The data processing chain used by the Keysight 8510 network analyzer. Transform calculations are performed BEFORE error correction and trace math. Learn more at the FieldFox Supplemental Online Help website:

<http://na.support.keysight.com/fieldfox/help/SupHelp/FieldFox.htm>

Trace Settings

The following two settings apply to specific traces.

Transform Enable

Enable Time Domain transform for the specific trace.

- Select the trace.
- Press **Measure Setup 4**
- Then **Transform**
- Then choose from:
 - **Transform On** Trace displays Time Domain data.
 - **Transform Off** Trace displays frequency domain data.

Gate Enable

Enable Gating for the specific trace.

- Select the trace.
- Press **Measure Setup 4**
- Then **Transform**
- Then choose from:
 - **Gating On** Trace displays Time Domain data.
 - **Gating Off** Trace displays frequency domain data.

Gating

Perhaps the most beneficial feature of Time Domain transform is the Gating function. When viewing the Time Domain response of a device, the gating function can be used to “virtually” remove undesired responses. You can then simultaneously view a frequency domain trace as if the undesired response did not exist. This allows you to characterize devices without the effects of external devices such as connectors or adapters.

Gating is best performed while viewing a Time Domain trace. Then, either disable Transform, or separately view a frequency domain trace to see the trace with the gated effects removed.

NOTE

When a discontinuity in a test device reflects energy, that energy will not reach subsequent discontinuities. This can “MASK”, or hide, the true response which would have occurred if the previous discontinuity were not present. The Gating feature does NOT compensate for this.

The following image shows how gating can affect measurement results.

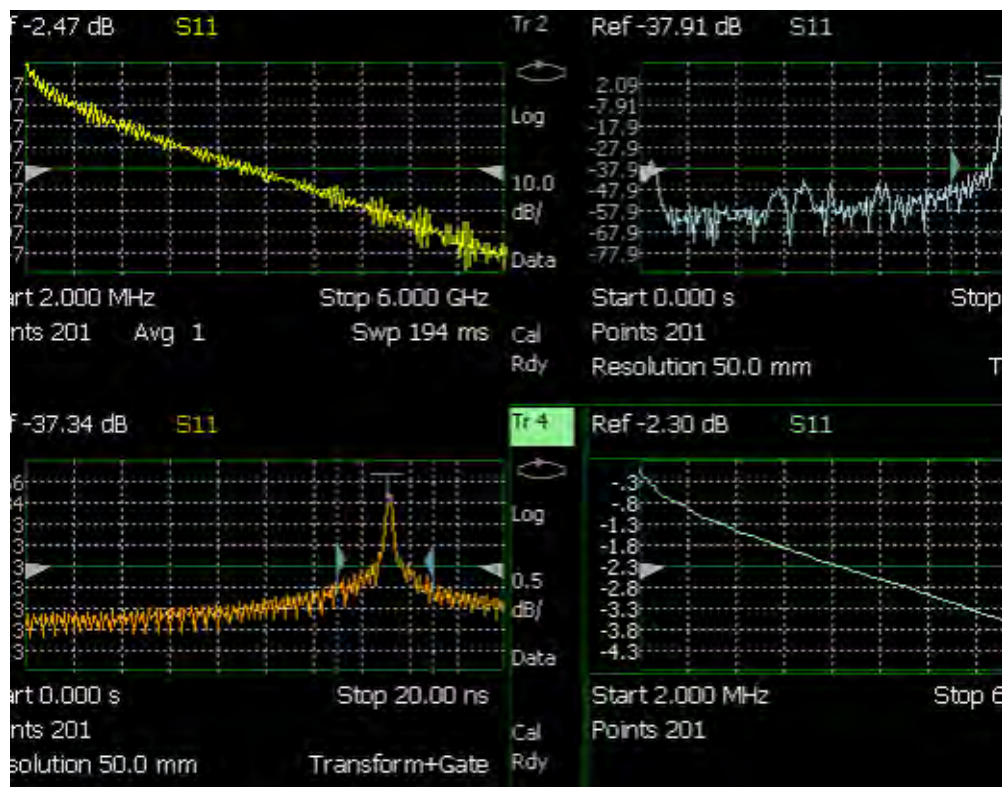

All 4 traces show the same S11 measurement.

Trace 1 shows the **frequency** response **without** gating enabled.

Trace 2 shows the **transform** response **without** gating enabled.

Trace 3 shows the **transform** response **with** gating enabled.

Trace 4 shows the **frequency** response **with** gating enabled.

How to make Time Domain Gating settings

- Press **Measure Setup 4**
- Then **Transform**
- Then **Gating**
- Then choose from:
 - **On** Gating is being performed.
 - **Off** Gating is NOT being performed.

Start, Stop, Center, and Span Gate Times

These settings specify the time in the trace to be gated (in or out). The gate times can be specified using either Start and Stop or Center and Span.

- Press **Gating Start Stop**
- A settings table appears that allows you to navigate and select the following settings. These settings are made exactly like those made on the Transform Settings table. Learn how in **“Transform Settings Table” on page 110**.

Gating Type

This setting defines the type of filtering that will be performed for the gating function. The gate start and stop flags on the display point toward the part of the trace you want to keep.

Choose from the following:

- **Bandpass** KEEPS the responses within the Gating Start and Stop times.
- **Notch** REMOVES the responses within the Gating Start and Stop times.

Gating Shape

This setting defines the filter characteristics of the gate function. Choose from Minimum, Normal, Wide, Maximum.

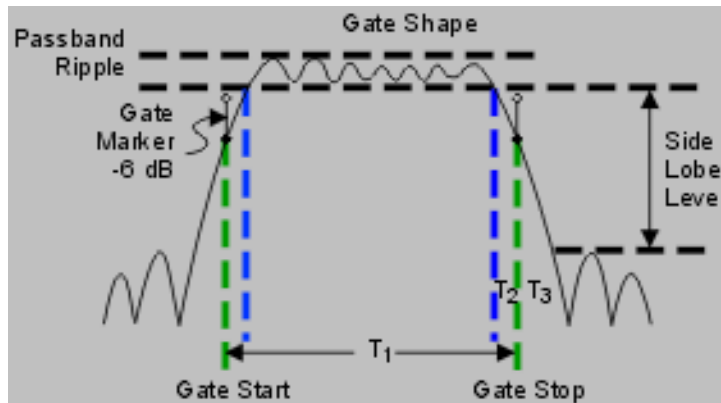

Time domain Gate Shape setting is shown in the graphic above.

Gate Shape	Passband Ripple	Sidelobe Levels	Cutoff Time	Minimum Gate Span
Minimum	±0.1 dB	-48 dB	1.4/Freq Span	2.8/Freq Span
Normal	±0.1 dB	-68 dB	2.8/Freq Span	5.6/Freq Span
Wide	±0.1 dB	-57 dB	4.4/Freq Span	8.8/Freq Span
Maximum	±0.01 dB	-70 dB	12.7/Freq Span	25.4/Freq Span

Cutoff time is the time between the stop time (-6 dB on the filter skirt) and the peak of the first sidelobe.

- T_1 is the gate span, which is equal to the stop time minus the start time.
- T_2 is the time between the edge of the passband and the 6 dB point, representing the cutoff rate of the filter.
- T_3 is the time between the 6 dB point and the edge of the gate stopband.

For all filter shapes T_2 is equal to T_3 , and the filter is the same on both sides of the center time.

Minimum gate span is twice the cutoff time. Each gate shape has a minimum recommended gate span for proper operation. This is a consequence of the finite cutoff rate of the gate. If you specify a gate span that is smaller than the minimum span, the response will show the following effects:

- distorted gate shape that has no passband
- distorted shape
- incorrect indications of start and stop times
- may have increased sidelobe levels.

8 Calibration for NA, CAT, and VVM Modes

Calibration removes the systematic errors that are associated with measurements in NA, CAT, and VVM Modes. Key presses are identical in all of these Modes.

In this Chapter

[“Why and When to Calibrate” on page 120](#)

[“Definitions” on page 120](#)

[“CalReady” on page 121](#)

[“How to Perform a Calibration” on page 121](#)

[“QuickCal \(N991xA/2xA/3xA Only\)” on page 123](#)

[“Mechanical Cal” on page 125](#)

[“ECal” on page 128](#)

[“Simple Response Cals ” on page 130](#)

[“View Cal” on page 132](#)

[“Calibration Type” on page 132](#)

[“Enhanced Response Optimization” on page 137](#)

[“Interpolation **” on page 138](#)

[“Cal ON ? – Questionable Accuracy” on page 138](#)

[“Compatible Mode Calibrations” on page 138](#)

[“Save the Calibration” on page 138](#)

[“CalReady Properties” on page 139](#)

[“Verify a Calibration” on page 140](#)

[“Test the Jumper Cable” on page 140](#)

See Also

Learn **How to Make 75 ohm Measurements** at the FieldFox Supplemental Online Help:

<http://na.support.keysight.com/fieldfox/help/SupHelp/FieldFox.htm>

Why and When to Calibrate

There are well-defined and understood systematic errors that are measured and calculated during the calibration process. These errors are caused by leakage signals inside the FieldFox, by the frequency response of the FieldFox receivers, and by reflections inside the FieldFox that interact with the DUT. After calibration, these errors are removed from subsequent measurements.

To maintain highest measurement accuracy, perform a new calibration when any of the following changes occur:

- When any of the following measurement settings change: Frequency Range, Power Level, IF BW, and Resolution. Therefore, make these measurement settings before calibrating. Increased Averaging, lower IF BW, and higher Resolution all cause slower sweeps and slower calibration times. Learn about Interpolation and Questionable Accuracy in **“Interpolation *” on page 138**.
- When the FieldFox temperature changes more than about 10°F (5°C). Learn more in **“How to monitor the internal FieldFox temperature:” on page 28**.
- When the connection to the DUT changes, requiring a different jumper cable or adapter.

Definitions

DUT (Device Under Test) The cable, antenna, transmission line, amplifier, or anything else that is connected to the FieldFox that is to be measured.

Calibration Standards - OPEN, SHORT, LOAD, and THRU

- **OPEN, SHORT, and LOAD** are ‘reflection’ standards that are used during calibration. When an RF signal ‘hits’ these components, the signals are reflected in a predictable manner. These components can also be used to terminate a DUT port during some measurements.
 - SHORT and OPEN standards both cause 100% of an RF signal to be reflected. The difference between these two standards is what happens to the phase of the reflected signal, which is beyond the

scope of this discussion. Although an OPEN standard is a precision component, simply leaving **nothing** connected at the end of a cable can be a reasonable substitute for an OPEN.

- A LOAD standard absorbs almost ALL of the incident signal and very little signal is reflected back to the source.
- A **THRU** standard is used during some calibration steps to connect PORT 1 to PORT 2 in place of the DUT. A Flush THRU connection can be made when cables that connect with the DUT can mate with each other. Learn more in **“Mechanical Cal” on page 125**. Otherwise, any reasonably short cable can be used as a THRU standard.

Calibration Reference Plane is the point (or points) at which the DUT and cal standards are connected during a calibration. This can be at the FieldFox test port connectors, or at the end of jumper cables or adapters.

CalReady

Every FieldFox contains a factory calibration that was performed at the port 1 and port 2 connectors, with -15 dBm input power, over the entire frequency range of the FieldFox using a number of data points that allows reasonable interpolation over the FieldFox frequency range.

This calibration, known as CalReady, allows you to immediately make measurements of a DUT that is connected directly at the test ports (PORT 1 and/or PORT 2). CalReady corrects measurements when the FieldFox is turned ON and when a measurement is created with no other correction in place.

When measuring a DUT using a jumper cable or adapter - NOT a direct connection to a test port connector - then a QuickCal or Mechanical Cal is recommended. CalReady can also be used to check the integrity of the jumper cable that is attached to the test ports.

CalRdy is shown when a measurement is corrected using CalReady.

You can change the properties of the CalReady calibration. Learn more in **“CalReady” on page 121**.

Learn how to see when your factory CalReady calibration was performed in **“System Information” on page 493**.

How to Perform a Calibration

NOTE

Press **Esc** at any time to end the calibration process.

When performing a calibration that contains a large number of points (5000 to 10,001 points) be aware that the calibration progress bar may not move for 2 or 3 minutes during the calibration process.

In CAT, NA, or VVM Mode, press **Cal 5**.

The following appears:

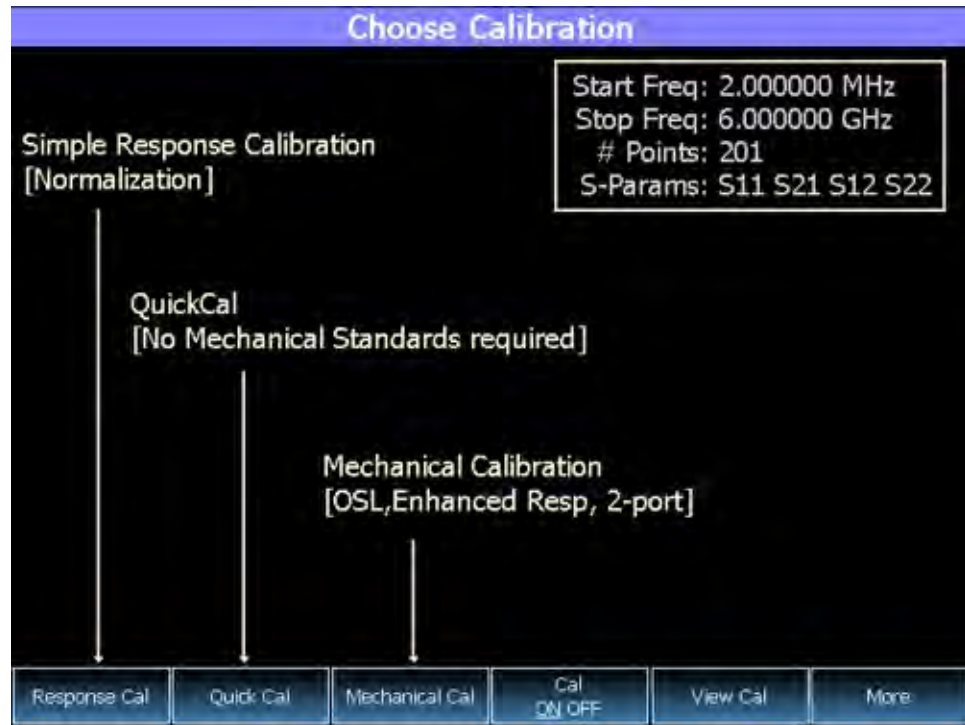

Choose Calibration Method screen

- **Response Cal** – Used to quickly calibrate ONE type of measurement using mechanical standards. Measurement accuracy is generally low. Learn more in [“Simple Response Cals ” on page 130.](#)
- **Quick Cal** – Using built-in cal standards and CalReady, quickly and accurately calibrate measurements when using a jumper cable or adapter to connect the DUT to the FieldFox test ports. Learn more in [“QuickCal \(N991xA/2xA/3xA Only\)” on page 123](#)
- **Mechanical Cal/ECal** – Using mechanical cal standards from a cal kit, perform an accurate calibration at one or both test ports, adapters, or jumper cables. Full 2-port mechanical calibration is the most accurate calibration available with FieldFox. Learn more in [“ECal” on page 128.](#)
- **User Cal OFF ON** – Turns ON and OFF the effects of the user calibration that you performed. The OFF state reverts to CalReady.
- **View Cal** – Shows the properties of the current calibration. Learn more in [“View Cal” on page 132.](#)
- **More** – Learn about Cal Ready Properties in [“CalReady” on page 121.](#)

NOTE

Source Unleveled errors - During calibration, the frequency range of the measurement MAY be extended to provide maximum flexibility. During the calibration, the output power may become unleveled at the added high frequencies. You can ignore the “Source Unleveled” error, or to avoid the error, select either High power or -15 dBm before calibrating. Learn more about setting Output Power in **“Output Power” on page 51**

QuickCal (N991xA/2xA/3xA Only)

QuickCal is ideal for a quick and simple calibration of the measurement when using a jumper cable or adapter to connect the DUT to the FieldFox test ports. QuickCal corrects for phase shift, time delay, and loss of adapters or jumper cables.

QuickCal does not require a specific Cal Kit and is a very simple calibration. If the highest accuracy is required, a mechanical calibration with a high quality calibration kit is recommended.

QuickCal is designed and most accurate when calibrating for DUTs fitted with **Type-N and 7/16** connectors.

If the DUT has different connectors, such as 3.5 mm (male) or SMA male connectors, QuickCal can still be used by selecting 'Other' connector. However, the accuracy of QuickCal with 'Other' connectors is not specified.

If the DUT has 3.5 mm-female or SMA-female connectors, QuickCal is NOT recommended. For accurate and repeatable measurements of devices with female 3.5 mm or SMA connectors, use mechanical calibration.

Important QuickCal Notes

- 7/16 connectors can be used with QuickCal ONLY up to 6 GHz.
- Type-N 75 Ohm can be used with QuickCal ONLY up to 3 GHz.
- QuickCal cannot be used with waveguides, or if the test fixture or test setup (before DUT) includes an attenuator.

How to perform a QuickCal

- In CAT, NA, or VVM Mode, press **Cal 5**
- Then **QuickCal**
 - Press **Change DUT Connectors** to select the correct connector types that are on your DUT. Although there is no Cal Kit required, selecting the connector type (limited to Type-N and 7/16) and gender from the list provides an accurate OPEN model which means a more accurate calibration. If the DUT connector type is not listed, select Unknown/Other.

- The connector choices that are offered depend on the frequency range. For example, if you have selected a frequency range that exceeds 18 GHz, the only connector options you will be presented with in QuickCal are 'other 50 ohm' or 'other 75 ohm'. This is because 3.5 mm connectors, which go beyond 18 GHz, are not supported with QuickCal.
- For each DUT port:
 - Select the connector type of the DUT using the ▲▼ arrows or rotary knob.
 - Press **Change Gender** to change the gender of the DUT connector.
 - Press **Next...** to make the selection.
 - If present, press **Finish**.
- Select/Change Cal Type. The FieldFox always RECOMMENDS a Cal Type that will quickly and accurately calibrate all of the displayed S-parameters. The other Cal Types that are listed will NOT necessarily calibrate all of the displayed S-parameters. Learn more about Cal Types in **“Calibration Type” on page 132**.
 - Using the ▲▼ arrows or rotary knob, select a Cal Type, then press **Select** and **Finish**.
- Press **Start Calibration**

No Connection

- Disconnect the DUT from the FieldFox.
- If a jumper cable or adapter is required to connect the DUT to the FieldFox, connect those components to the FieldFox test ports connectors. The effects of those components will be measured and removed during the calibration, and only the effects of the DUT will be displayed in the measurement results. These should be high-quality components!
- Do NOT connect anything at the cal reference plane where the DUT connects.
- Press **Measure**

Optionally Connect Load(s)

- Connect a Load standard at the point where the DUT will be connected and press **Measure** under the following conditions:
 - When a jumper cable has too much loss. If a 'Cal Failed' error appears and you skipped the Load measurement, then perform the Cal again but include measuring the Load.

- When your DUT has high return loss such as the reject band of a filter. Then measuring the load improves accuracy. Even with the optional Load, phase accuracy begins to degrade when the return loss is greater than about 20dB.
- Press **Skip Step** in all other cases and when making DTF measurements. Measuring a load would do little to improve accuracy.

Connect THRU (Not used for 1-port cals)

- Connect port 1 to port 2, either by mating the connectors that attach to the DUT (Flush THRU), or by using a short jumper cable. Learn more about Flush THRU in “**Calibration Type**” on page 132. Then press **Measure**.
- Press **Finish**.

CAL ON Q is shown on the screen for all displayed measurements that are corrected with QuickCal.

Using QuickCal with a Long Jumper Cable

QuickCal requires a sufficient frequency span to adequately characterize the jumper cable (the cable between the instrument port and the DUT). If a ‘Cal Failed’ error appears and you connected the optional Load standard, then increase the frequency span of the measurement until the error no longer appears. After the calibration, you can then decrease the frequency span as needed and rely on interpolation. Learn more about Interpolation in “**Interpolation ***” on page 138.

QuickCal is also limited in how much jumper cable loss it can tolerate. If QuickCal without the Load is failing, then measure the Load during the QuickCal to see if that resolves the issue.

Mechanical Cal

Mechanical Calibration is performed using discrete standards from a Cal Kit. Several Cal Kit definitions are built into the FieldFox. To learn about Cal Kit definitions, refer to the Application Note, “Specifying Calibration Standards and Kits for Keysight Vector Network Analyzers,” available online at <http://literature.cdn.keysight.com/litweb/pdf/5989-4840EN.pdf>

NOTE

Visit www.keysight.com/find/fieldfoxsupport to see a complete list of supported Cal Kits. Also at this website, download Data-Link software that allows you to edit Cal Kit definitions or add a new Cal Kit.

Mechanical Cals are extremely accurate when performed using the correct Cal Kits with standards that are clean and in good repair, and when using correct connection procedures.

How to perform a Mechanical Cal

- Disconnect the DUT from the FieldFox.

- If a jumper cable or adapter is required to connect the DUT to the FieldFox, then connect **those** components to the FieldFox connectors. The effects of those components will be measured and removed during the calibration, and only the effects of the DUT will be displayed in the measurement results. **These should be high-quality components!**
- In NA, CAT, or VVM Mode, press **Cal 5**.
- Then **Mechanical Cal**

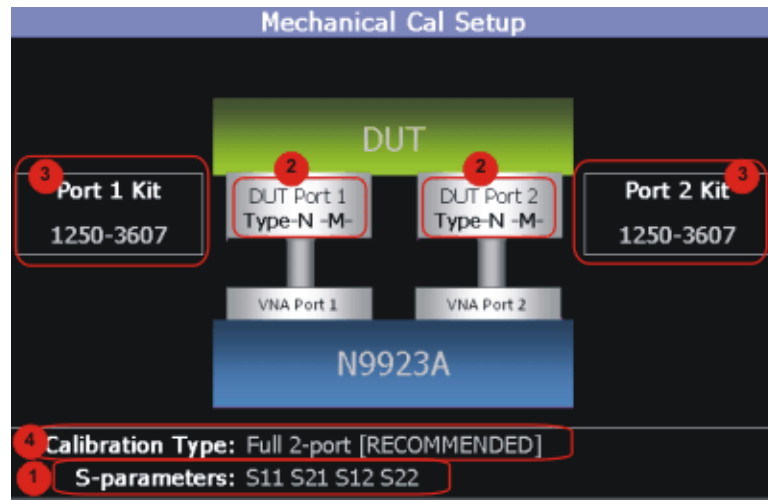

This page summarizes the Mechanical Cal to be performed and allows you to make changes. For best results, review the screen and make changes in the following order:

1. **S-parameters** – Verify that these are all of the S-parameters that you want calibrated. If not, press **Esc** to terminate the calibration process, then return to the Trace menu to display all of the traces to be calibrated. Learn how in **“Multi-Trace Configurations” on page 89**
2. **DUT Connectors** – For each DUT port that is shown, verify the correct type and gender of the DUT connector. If a DUT port is not shown, then that port is not included in the list of S-parameters to be calibrated.
3. **Cal Kit** - Verify the correct Cal Kit for each DUT port to be calibrated. See a list of supported Cal Kits in the FieldFox Data Sheet. Learn more in Appendix B.

If the DUT connector type, gender, or Cal Kit is **NOT** correct for the DUT ports to be calibrated, then:

- Press **Change DUT Connectors** to select the correct connector types that are on your DUT.
- For each port:
 - Use the **▲▼** arrows or rotary knob to change the DUT connector type.

- Press **Change Gender** to change the gender of the DUT connector.
- Then press **Next...** to confirm the selection and continue the process.
- For each port:
 - Use the **▲▼** arrows or rotary knob to select the Cal Kit that you have, and are going to use, for the specified ports.
 - Press **Next...** to confirm the selection and continue the process.
 - Then press **Finish** to end the selection process.

4. Calibration Type - The FieldFox always RECOMMENDS a Cal Type that will quickly and accurately calibrate all of the displayed S-parameters. Change from the RECOMMENDED Cal Type ONLY if you understand the implications. Learn more about Cal Types in “**Calibration Type**” on [page 132](#).

To select a different Cal Type:

- Press **Change Cal Type**.
- Then using the **▲▼** arrows or rotary knob, select a Cal Type,
- Then press **Select and Finish**.

Begin Calibration

- Press **Start Calibration**.

NOTE

If an error appears (“Failure to compute calibration steps...”), check to ensure that the frequency range of the Cal Kit covers the frequency range of the measurement. You can verify the frequency range of your Cal Kit at: www.keysight.com/find/fieldfoxsupport. Click Cal Kits.

- Follow the Cal Wizard prompts. Connect the specified standard at the point where the DUT will be connected, then press **Measure**.
- At any time, press **Back** to re-measure a standard if you feel it was not properly connected.
- Press **Finish** to complete the calibration.

CAL ON U is shown on the screen for all displayed measurements that are corrected with the Mechanical Cal.

ECal

CAUTION

ECals each have a recommended input power level. Depending on the measurement setup, the FieldFox may default to an input power level that exceeds your ECal's recommended input power level. Refer to the reference guide for your ECal module to determine the correct input power levels. Exceeding an ECal's recommended input power level results in a compression and an invalid data condition. Refer to www.keysight.com/find/ecal.

ECal is a complete solid-state calibration solution. Every ECal module contains electronic standards that are automatically switched into position during a calibration. These electronic standards have been measured at the factory and the data stored within the memory of the ECal module. The FieldFox uses this stored data, along with the measured data, to calculate the error terms for a measurement calibration.

You can perform the following calibrations with ECal:

- 1-Port Reflection calibration
- Full 2-Port calibration

CAUTION

Simple ECal ON: When choosing **Full 2-port** calibration, if you are able to connect your ECal simultaneously to both device ports, you should use **Simple ECAL** (i.e, this ensures that you are using the correct Thru calibration model).

Simple ECal OFF: Set simple ECal to OFF when you have a test setup where you cannot connect port 1 and port 2 simultaneously to the ECAL module (Then during the calibration when prompted: "**Connect port 1 to port 2**", use a coaxial cable or an appropriate thru adapter to connect port 1 to port 2).

'Unknown THRU': When prompted: "**Connect port 1 to port 2**", then you can connect them, using a coaxial cable or an appropriate thru adapter. Do NOT use the internal ECal THRU, because the thru calibration will be incorrect.

'Flush THRU': When prompted: "**Connect port 1 directly to port 2**", then you must connect the ports directly together at the calibration reference plane with no adapter or other cabling.

Learn more in "[Calibration Type](#)" on page 132.

All Keysight USB ECal modules are supported. ECal modules are available in a variety of connector types, covering many frequency ranges. For information about available ECal modules, see <http://www.keysight.com/find/ecal>

Select an ECal module that has connectors of the same type and gender as the DUT. If such an ECal module is not available, a module with connectors different from the DUT can be used by selecting a User Characterization. This selection is located on the Mechanical Cal Setup page of the CalWizard. However, a User Characterization can NOT be PERFORMED using the FieldFox. It must be performed using a bench top Keysight VNA, such as the PNA or ENA. Learn more about User Characterization at the PNA Help website: http://na.support.keysight.com/pna/help/latest/S3_Cals/ECal_User_Characterization.htm.

How to Perform a Calibration Using ECal

- Make measurement settings on the FieldFox (frequency range, number of points, etc.)

NOTE

The frequency range of the measurement **MUST** be within the frequency range of the ECal module or an error will appear when “Calculating Steps” during the calibration.

- Connect the ECal module USB cable to the FieldFox USB.
- Allow the module to warm up until it indicates READY. This may take several minutes.
- Connect the ECal module ports to the FieldFox at the calibration reference plane (where the DUT will be connected).
- Press **Cal 5** to start the Calibration.
- Press **Mechanical Cal / ECal**
- Press **Change DUT Connectors**. For each test port to be calibrated, select the **Connector Type** and **Gender** of the DUT / ECal module. The connected ECal module and relevant User Characterizations will appear, with the ECal factory default as the default Cal Kit.
- Optionally press **Advanced** then **ECal Auto Orient**.
 - **ON** (default) The FieldFox automatically senses the direction in which the ECal module ports are connected to the FieldFox ports.
 - **OFF** If power to the ECal module is too low, it cannot detect which FieldFox ports it is connected to. If you are having this problem, select OFF. Then during the calibration, the FieldFox will prompt you to connect the ECal module ports to specific FieldFox ports.
- Optionally press **Advanced** then **Extended Cal** (N995xA/6xA Only).
 - **ON** The FieldFox Extended Cal measures additional points outside the current frequency range in order to enable adjusting the frequency range after the calibration procedure. With these extra points, the error correction may be applied when it otherwise might

not. Without extended cal, if you adjust your frequency outside the calibrated range after the calibration has been completed, the error correction is turned off.

- **OFF** (default) The FieldFox does not measure any frequency points outside the current displayed frequency range. If the frequency is adjusted outside of the set of points calibrated the error correction is turned off and the following message is displayed:
"Error correction disabled. Stimulus outside calibrated range."
- Press **Start Calibration**. When prompted, verify the ECal module connection, then press Measure. The standards within the ECal module are automatically connected and measured.

CAUTION

'Unknown THRU': When prompted: **"Connect port 1 to port 2"**, then connect port and port 2, using a coaxial cable or an appropriate thru adapter. Do NOT use the internal ECal THRU, because the ECal thru calibration model is incorrect for this calibration type.

'Flush THRU': When prompted: **"Connect port 1 directly to port 2"**, then you must connect the ports directly together at the calibration reference plane with no adapter or other cabling.

Learn more in ["Calibration Type" on page 132](#).

Simple Response Cals

Simple Response Cals are used to quickly calibrate the magnitude and phase of a measurement using any Open, Short, or Thru component. These may be calibration standards, but because a Cal Kit is not selected, they are not modeled. Measurement accuracy is generally low. Use a Simple Response Cal to make quick measurements when using a jumper cable to connect the DUT to the FieldFox. Otherwise, CalReady is usually more accurate.

NOTE

You can perform a Simple Response Cal for either: S11, or S22, or S21 AND S12.

When prompted, choose a standard based on the displayed measurements to be calibrated. For example, to calibrate S11, connect either an OPEN or SHORT to the port 1 reference plane.

When Simple Response Cals are performed, the source match and reflection tracking terms from CalReady are updated by the measured Short or Open that is used during the calibration.

1-port response cals are also available from the Mechanical Cal menu. Learn more in ["Calibration Type" on page 132](#).

Normalize uses a THRU standard or cable between port 1 and port 2 to cal an S21 and S12 Transmission measurement (NA Mode) and a 2-port Insertion Loss measurement (CAT Mode). In VVM Mode, this is performed using Zero.

When a Normalization is performed, the forward and reverse transmission tracking terms from CalReady are updated to account for the THRU that is used during the normalization process.

How to perform a Simple Response Cal

- Select the measurements to be calibrated. See the relevant Mode (NA, CAT, or VVM) for measurement selections.
- Press **Cal 5** then **Response Cal**
- For 1-port measurements:
 - Select either **Open Response** or **Short Response** for the port to be calibrated. The availability of this calibration on Port 2 may require an option.
 - Connect an OPEN or SHORT standard to the specified port and press **Measure**
- For 2-port measurements:
 - Select **Normalization**
 - Connect a short, high-quality, phase stable cable between the FieldFox port 1 and port 2 connectors, then press **Measure**

NOTE

With a Normalization Cal, all subsequent insertion loss measurements are made relative to the insertion loss of the cable used as the THRU standard. For example, if you use a cable with 1 dB of loss, then after Normalization, the display will show 0 dB of loss with this cable in place. Therefore, for highest accuracy, when measuring the DUT also attach the cable that was used in the normalization cal.

-
- Press **Finish**.
 - Connect the DUT.

CAL ON U is shown on the screen when a User Cal (Ex: Response Cal) is correcting ONLY the appropriate measurement. For example, when an Open Response Cal on Port 2 is performed, **CAL ON U** is shown for an S22 measurement only.

View Cal

From the **Choose Calibration** screen (see [“How to Perform a Calibration” on page 121](#)), press View Cal to see the following screen:

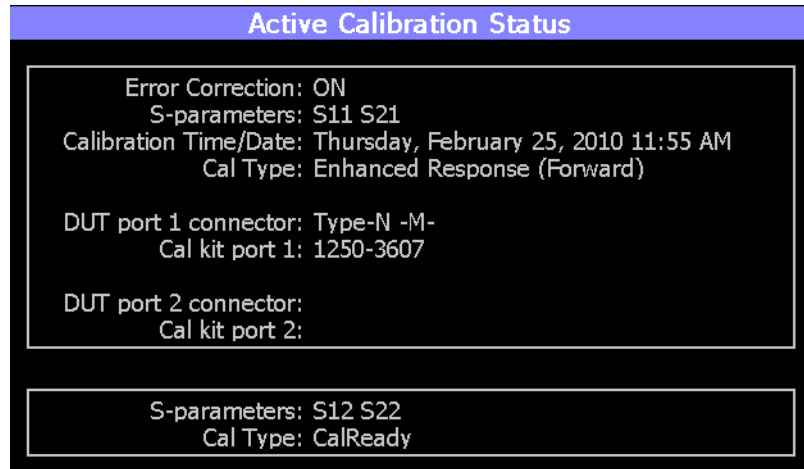

The top box shows the properties of the current calibration that you performed and the displayed S-parameters that it is correcting.

The bottom box shows the S-parameters that are displayed but NOT corrected by the current performed calibration, but rather the CalReady calibration. Learn more about CalReady in [“CalReady” on page 121](#).

Calibration Type

The FieldFox simplifies the calibration process by recommending the most accurate and efficient calibration type based on the displayed S-parameters.

However, there may be times when you may want a little more accuracy or a little faster sweep time. The following information can help you learn about the various calibration choices.

Definitions:

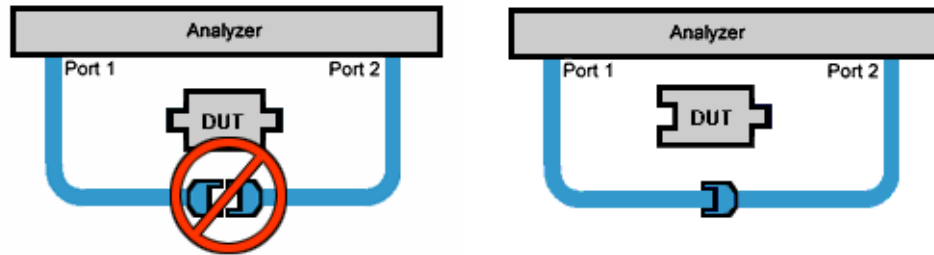

Non-insertable DUT – A device whose connectors could NOT mate together. They either do not have the same type of connector or they have the same gender. This also means that the test port cables could NOT mate together as in the above diagram.

Insertable DUT – A device whose connectors could mate together. They have the same type of connector and opposite or no gender. This also means that the test port cables could mate together, as in the above diagram.

Defined THRU – A THRU standard for which there is a Cal Kit definition such as in the 8551xA Cal Kits.

Flush THRU (also known as Zero length THRU) – When the test port cables mate together when measuring an Insertable DUT. No actual THRU standard is required because the test port cables are directly connected. Flush THRU is also a Defined THRU with a definition of zero loss and zero length.

Unknown THRU – Any THRU connection between the test ports. For more information see the FieldFox Supplemental Online Help:

<http://na.support.keysight.com/fieldfox/help/SupHelp/FieldFox.htm>

Sweep Directions – Both FULL 2-Port Cals listed below result in correction that requires background measurements sweeps in both directions, regardless of the displayed measurements. The displayed traces are updated at a slower rate than Enhanced Response and 1-port calibrations, which require sweeps in one direction only.

1-Port (OSL)

DUT: No restrictions

S-parameters Corrected: S11 or S22

Standards: OPEN, SHORT, LOAD

Sweeps in ONE direction.

FULL 2-Port (May require an option)

Most comprehensive calibration. Corrects all S-parameters

DUT: Non-Insertable or Insertable

Standards: OPEN, SHORT, LOAD on **BOTH** ports. Any THRU between ports.

Based on the SOLR/Unknown THRU calibration. For more information on the Unknown THRU process, see the FieldFox Supplemental Online Help: <http://na.support.keysight.com/fieldfox/help/SupHelp/FieldFox.htm>

Sweeps in BOTH directions.

FULL 2-Port (QSOLT) – Mechanical Cal ONLY (May require an option)

Quicker to perform QSOLT than Full 2-port. Corrects all S-parameters.

DUT: Insertable only

Standards: OPEN, SHORT, LOAD on port 1. Flush THRU between ports.

Recommended cal type for Insertable DUTs. A Cal Kit is NOT required for port 2.

Sweeps in BOTH directions.

Enhanced Response Cal - Forward OR Reverse (May require an option)

Faster measurements than Full 2-Port.

DUT: Non-Insertable or Insertable. S-parameters PARTIALLY Corrected: S21 and S11 (Forward) **OR** S12 and S22 (Reverse)

Standards: OPEN, SHORT, LOAD on **ONE** port. Defined or Flush THRU between ports.

Sweeps in ONE direction.

NOTE

Also select an Enhanced Response Optimization. Learn more in **“Enhanced Response Optimization” on page 137.**

TRL – Mechanical Cal ONLY

A complete 2-Port calibration with potentially better accuracy than Full 2-port. Corrects all S-parameters.

DUT: Non-Insertable or Insertable

Standards: Thru, Reflect, Line or variations of these. A TRL Cal Kit **MUST** be selected to see this Cal Type

Sweeps in BOTH directions.

Learn more about TRL Calibration in the Supplemental Online Help: <http://na.support.keysight.com/fieldfox/help/SupHelp/FieldFox.htm>

1-port Response Cals (Open or Short)

Calibrate the magnitude and phase of a measurement using ‘modeled’ mechanical standards. Measurement accuracy is better than Simple Response Cals (available on the main Cal page - see **“Calibration Type” on page 132**) but NOT as good as full 1-port cal. Corrects either S11 or S22. Can be used with Isolation (see following section). Learn more in **“Simple Response Cals ” on page 130**

DUT: Non-Insertable or Insertable

S-parameters Corrected: S11 or S22

Standards: OPEN or SHORT on ONE port

Sweeps in BOTH directions.

Isolation Step

The optional isolation step of a calibration corrects for crosstalk which is the internal signal leakage between the test ports. The Isolation step measures Load standards that are connected to one or both FieldFox test ports.

Perform an isolation calibration when you are testing a device with high insertion loss, such as the stop band of a filter or a switch in the open position.

The isolation step can add noise to the error model when the measurement is very close to the noise floor of the analyzer. To improve measurement accuracy, set a narrow IF Bandwidth during the calibration.

The Isolation step is NOT allowed with ECal or QuickCal.

How to perform the Isolation step

- Press **Cal 5** then **Mechanical Cal / ECal**
- Then **Advanced**
- Then **Omit Isolation**
 - **OFF** Perform the Isolation step
 - **ON** (default) Omits the Isolation step
- Then **<Back**
- Configure and perform the calibration as usual. At the first step of the Cal you will be prompted to connect a Load standard to one or both test ports.

NOTE

If the first calibration step does NOT prompt you to connect Load standards, then the Cal Kit probably does not contain an Isolation standard. You can use DataLink software to edit the Cal Kit and add an isolation standard using a Load standard. See Data Link Help for more information:
<http://na.support.keysight.com/help/DataLinkHelp/DataLink.htm>

- This setting survives an Instrument Preset.

Waveguide Calibrations

In general, calibrating with Waveguide is very similar to calibrating with coax. However, most coax mechanical Cal Kits have standards that can be used over a very wide frequency range. Waveguide Cal Kits are used over a narrow frequency range. Therefore, it is VERY IMPORTANT to set the frequency range

of the measurement WITHIN the frequency range of the waveguide Cal Kit. Otherwise, an error message will appear during the 'Calculating Steps' portion of the calibration.

Waveguide Cal Kits

Keysight sells two waveguide Cal Kit series: the premium 11644A series and the economy N9911X series. Both are available online at www.Keysight.com

Effective Velocity Factor

Velocity factor is the speed at which an electromagnetic signal passes through the transmission medium relative to the speed of light. This value is important when distance is being calculated in DTF measurements (CAT mode) and Time Domain (NA mode).

When the media is waveguide, the velocity factor changes with frequency. FieldFox calculates this 'effective' velocity factor automatically. However, the settings are different for CAT mode and NA mode.

CAT Mode - How to make Waveguide settings

These settings are necessary ONLY when making DTF measurements.

- Press **Measure 1** then **Distance to Fault (dB)** to select a **DTF** measurement.
- Press **Meas Setup 4**
- Then **Settings** (Learn how to use the Quick Settings table in “How to view and change Quick Settings” on page 46.)
- Set **Media = Waveguide**. Frequency Mode = **BandPass** is automatically selected for you.
- Scroll down to **Waveguide Definitions**. Select the **Waveguide Standard** being used. If your waveguide standard is NOT listed:
 - Select **User Waveguide**. Then press **Done**.
 - Then **DTF Cable Specifications**, then **Edit/Save/Recall Cables**, then **Edit Cable**.
 - Scroll to set **Waveguide Definition**. The default setting is **VF Corr = Auto**.
 - Set the Min, Max, and Cutoff Frequencies.
- Press **Done**, then press **Back**.
- **Cable Correction = Auto** is the default setting. The Effective Velocity Factor is calculated automatically based on the frequencies of the waveguide standard. To override this setting, set Cable Corr = **Man**.

NA Mode - How to make Waveguide settings

These settings are necessary ONLY when your measurement requires electrical delay or port extensions, or if using Time Domain Transform.

- Press **Meas Setup 4**
 - Then **Transform**
 - Then **Transform Settings**
 - Under **Transform Stimulus Settings**, set the **Start** and **Stop** frequencies to those of the Waveguide.
 - Set **Stimulus = Bandpass Impulse**
 - Press **Done**
 - Press **Meas Setup 4** or **Back**
 - Then **Calibration Settings**
 - Set **Media = Waveguide**
 - Set **Cutoff Frequency**. This is the absolute minimum frequency of the waveguide. This value must be less than the Start Frequency of the Waveguide.
- Enter the calculated **Effective VF** value into the Velocity Factor setting.

Enhanced Response Optimization

When Enhanced Response Cal Type is selected, either for one calibration or for CalReady, this setting optimizes the calibration based on the type of DUT being measured. See also: CalReady Properties in “**CalReady**” on page 121.

This setting does NOT survive Preset.

- Press **Cal 5** then **More**
- Then **Enh.Response**
- Then choose from:
 - **NonReciprocal** (default) An amplifier is a Non-Reciprocal device because it has gain in the forward direction, and very high loss (isolation) in the reverse direction. This choice provides the best correction for non-reciprocal devices, and reasonable correction for reciprocal devices.
 - **Reciprocal** A reciprocal DUT is a device in which the insertion loss through the device is equal in both the forward (S21) and reverse (S12) directions. A cable is a reciprocal device. This choice provides the best correction for reciprocal devices. However, S11 measurements on non-reciprocal devices will appear to have more return loss than the non-reciprocal choice.

Interpolation *

Highest measurement accuracy is achieved when the frequency range or resolution settings remain the same during the measurement as when the FieldFox was calibrated. If these settings change after performing a calibration, the FieldFox will interpolate the calibration so that VERY accurate measurements continue to be made.

Interpolated Calibrations are only slightly less accurate than a calibration performed at the measurement settings. Learn more about the relative accuracy of FieldFox calibrations in [“Cal ON ? – Questionable Accuracy” on page 138](#).

When a calibration that you performed is being interpolated, an asterisk is added to the Cal annotation. For example: Cal ON U* is shown on the screen when the current Response or Mechanical cal is being interpolated. An * is never added to a CalRdy.

Cal ON ? – Questionable Accuracy

When the Output Power, Interference Rejection, or IF BW (NA Mode ONLY) setting is changed AFTER performing a calibration, a question mark is added to the Cal annotation. For example: Cal ON Q? is shown on the screen when the current QuickCal is being interpolated. A ? is never added to CalRdy.

NOTE

QuickCal is only available on N991xA/2xA/3xA models.

The resulting measurement accuracy depends on how much the setting has changed. For highest accuracy, recalibrate using the new settings.

Compatible Mode Calibrations

The FieldFox can have only ONE calibration present for all modes. Because NA, CAT, and VVM modes are very similar, a calibration that is performed in one mode can also be applied in the other modes with the same type of measurements (1-port or 2-port).

To apply a Cal that was performed in a different mode, press **Cal 5** then select [User Cal ON](#).

Save the Calibration

After performing any type of calibration, you can save the FieldFox settings along with the calibration into a STATE (*.sta) file. These settings and calibration can then be recalled as necessary. To learn how, see [“Saving and Recalling Files” on page 498](#).

CalReady Properties

There are several factory calibrations (CalReady) on every FieldFox. These can be selected based on the type of DUT that you measure most often, and the compromise that you prefer to make between measurement speed versus measurement accuracy. Remember, CalReady was performed at the test ports. Therefore, a CalReady calibration is most accurate when the DUT is directly connected to the test ports. Learn more in [“CalReady” on page 121](#).

This setting does NOT survive Preset or Power ON/OFF.

- Press **Cal 5** then **More**
- Then press **CalReady** to toggle between the following selections:
 - **2-Port Cal** (default) Corrects all four S-parameters. Requires a forward and reverse sweep, which causes slower trace measurements. Learn why in [“Calibration Type” on page 132](#).
 - **Enh. Response** Corrects forward (S21 and S11) and reverse (S12 and S22) measurements separately. Therefore, when measurements in only one direction are required, this choice provides faster trace measurements than a full 2-port cal. Also choose an Enhanced Response Optimization. Learn more in [“Enhanced Response Optimization” on page 137](#).

To find the best choice for your DUT:

- Press **Preset** then **Preset**.
- Select the appropriate S-Parameter and other settings (frequency range, resolution, and so forth).
- Press **Trace 6** then **Math and Memory** then **Data->Mem**.
- Press **Data & Memory**.
- Press **Cal 5** then **More**
- Select a CalReady Cal to compare with the current setting.
- Press **Esc** to exit the cal menu.
- View the differences in the two traces.

Verifying Calibration and Jumper Cable Integrity

After calibrating, it is important to verify that the calibration is good. When using a jumper cable, also verify that the cable is of high quality.

Verify a Calibration

- Connect a LOAD standard at the calibration reference plane (where calibration standards were connected). This may be at the end of the jumper cable or at FieldFox **PORT 1** connector.
- In CAT Mode, select **Return Loss**.
- In NA Mode, select **S11** with Log Mag format.
- For frequencies **lower than 9 GHz**, observe the trace on the FieldFox screen:
 - Lower than 35 dB indicates a GOOD calibration.
 - Higher than 30 dB indicates that you should recalibrate.

Verifying Phase Accuracy

- Connect a LOAD standard at the calibration reference plane (where calibration standards were connected).
- In NA Mode, select a S11 Reflection with Polar or Smith Chart format.
- Because all LOAD standards have delay, you should see a small amount of phase rotation as a function of frequency. In general, the measurement result should agree with the characteristics of the calibration standard.

Test the Jumper Cable

With the LOAD standard still connected, move the jumper cable while observing the trace.

- If the measurement trace is relatively stable, the jumper cable is of good quality.
- If you observe significant movement in the peaks of the measurement trace when moving the cable (>5 dB), the jumper cable may need to be replaced.

Calibration Method Summary

- **Mechanical Full 2-port Cal** is ALWAYS the most accurate Cal method. The quality of a Mechanical Cal is completely dependent on the quality of the OPEN, SHORT, LOAD standards and the quality of the standard connections. Use the correct high quality standards to ensure the most accurate calibration.
- **QuickCal** is ideal for DTF measurements. QuickCal should be performed when good accuracy is required and when using a jumper cable or adapter.

NOTE

QuickCal is only available on N991xA/2xA/3xA models.

-
- QuickCal is NOT recommended when the DUT has 3.5 mm-female or SMA-female connectors.
 - Even with the optional Load, phase accuracy begins to degrade when the return loss is greater than about 20dB.
 - **CalReady** is accurate ONLY when the DUT is directly connected at the test ports and most accurate at room temperature.
 - **For highest accuracy**, a new QuickCal or Mechanical Cal should be performed:
 - When the temperature changes more than about 10°F (5°C)
 - When the connection to the DUT requires a different jumper cable or adapters.
 - When any of the following measurement settings change: Frequency Range, Power Level, IF BW, and Resolution.

Calibration for NA, CAT, and VVM Modes
Calibration Method Summary

9 SA (Spectrum Analyzer) Mode

NOTE

To better reflect the enhancements implemented during the alignment process, for firmware versions >A.10.15 "IF Flatness Alignment" is now referred to as "Channel Equalization" or "Channel Equalization Alignment" ([ChanEQ Alignment](#)).

SA Mode measures signals at the **SA RF IN** connector.

SA Mode measurements require NO calibration.

For a comprehensive SA mode tutorial, see Spectrum Analysis Basics (App Note 150) at <http://literature.cdn.keysight.com/litweb/pdf/5952-0292.pdf>

For information on using the FieldFox Remote Viewer which enables you to view the FieldFox from your iOS device, refer to <http://literature.cdn.keysight.com/litweb/pdf/5991-2938EN.pdf>

Figure 9-1 SA Display with Markers

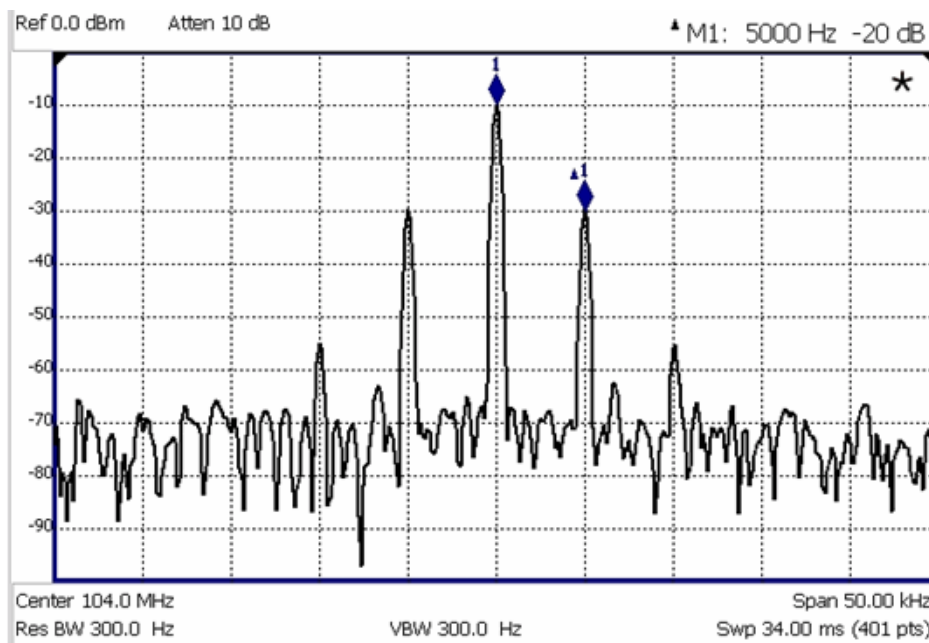

The graphic above shows an SA display with markers.
Carrier with 5 kHz frequency modulation and deviation of 1 kHz.

In this Chapter

“Frequency Range” on page 146

“Radio Standard” on page 148

“Channel Selection” on page 149

“Reverse Swap” on page 151

“Scale and Units” on page 151

“External Gain” on page 152

“Attenuation Control” on page 152

“Preamplifier Control (Opt 235)” on page 153

“Check for Compressed Measurements” on page 153

“Field Strength Measurements” on page 154

“Using the Antenna/Cable Editor” on page 156

“Source Tracking Offset and Offset Reversal” on page 158

“Tune & Listen (AM/FM)” on page 159

“Independent Source/Tracking Generator ” on page 161

“Resolution Bandwidth (Res BW)” on page 163

“Video Bandwidth (Video BW)” on page 164

“Sweep Type” on page 164

“IF Output” on page 165

“Sweep Acquisition” on page 166

“Very Long Sweep Times” on page 167

“Zero Span Measurements” on page 167

“Triggering” on page 169

“FFT Gating (Opt 238)” on page 172

“Single / Continuous / Restart” on page 174

“Points ” on page 174

“Trace Display States (SA Mode)” on page 175

“Average Type” on page 176

“Average Count” on page 176

“Alignments” on page 177

[“RF Burst Amplitude Alignment” on page 182](#)

[“Detection Method” on page 184](#)

[“Display Line” on page 186](#)

[“Noise Marker” on page 187](#)

[“Band/Interval Power Marker” on page 187](#)

[“Frequency Counter at Marker” on page 188](#)

[“Audio Beep at Marker Power” on page 189](#)

[“Meas UNCAL Error” on page 190](#)

[“Old Data Indicator \(*\)” on page 190](#)

[“Radio Standards and Channel Measurements” on page 191](#)

[“Measurement Preset” on page 191](#)

[“Averaging” on page 191](#)

[“Traces” on page 192](#)

[“Channel Power \(CHP\)” on page 192](#)

See Also

Interference Analyzer:

[“Spectrogram Display \(SA Option\)” on page 270](#)

[“Waterfall Display” on page 273](#)

[“Record/Playback \(SA Option\)” on page 275](#)

Optional Settings:

[“All about Markers” on page 438](#)

[“All about Limit Lines” on page 453](#)

[“Saving and Recalling Files” on page 498](#)

SA Mode Settings

Select SA Mode before making any setting in this chapter.

Because there is no calibration, these settings can be made in any order.

How to select SA Mode

- Press **Mode**
- Then **SA**.

Frequency Range

The X-axis frequency range determines the frequencies that are measured for each sweep. The default Start frequency is 0 Hz. However, the Start frequency can be set as low as –100 MHz. The internal LO of the FieldFox can be seen at 0 Hz, which will mask signals that may be present.

NOTE

Although the start frequency can be set as low as –100 MHz, amplitude accuracy is specified above 100 kHz. Below 100 kHz, frequency accuracy is maintained, but amplitude accuracy is degraded.

Available ONLY with Opt. 209 and while in Step sweep, SA mode allows reverse sweeps. This means the Start frequency can be higher than the Stop frequency. In addition, the **Reverse Swap** feature can be used to quickly reverse the Start and Stop frequencies. Learn how in **“Reverse Swap” on page 151**.

The frequency range of the measurement can be changed using the following methods:

- Set Center and Span frequencies
- Set Start and Stop frequencies
- Toggle between Zero and Last selected span
- Set Full Span of the FieldFox
- Using Channel selection. Learn how in **“Channel Selection” on page 149**.
- Using Marker -> Center (frequency). Learn how in **“SA Marker Functions” on page 452**.

How to set Frequency Range

- Press **Freq/Dist**.
- Then choose from the following:
 - **Center** and **Freq Span** frequencies. This is the most common method of entering frequency range. Enter the frequency of interest. The Center frequency is at the exact center of the X-axis. The Frequency

Span places half of the frequency range on either side of center. When the Center and Frequency Span values are entered, then the X-axis annotation on the screen shows the Center and Span frequencies.

- **Start** and **Stop** frequencies. Start is the beginning of the X-axis and Stop is the end of the X-axis. When the Start and Stop frequencies are entered, then the X-axis annotation on the screen shows the Start and Stop frequencies.
- Follow each of these by entering a value using the numeric keypad, the **▲▼** arrows, or the rotary knob.
- When using the **▲▼** arrows, press **Enter**. The increment setting of the arrows is based on the current span. This can be changed in SA Mode. See **How to change frequency step size** below.
- After using the keypad, select a multiplier key. Learn more in **“Multiplier Abbreviations” on page 41**.

Two more ways to change the frequency range

- Press **Freq/Dist**
- Then choose from the following:
 - **Zero/Last Span** Each key press toggles the frequency span between 0 Hz and the last specified frequency span. Learn more about Zero Span in **“Zero Span Measurements” on page 167**.
 - **More**
 - Then **Full Span** Selects the entire frequency span of the FieldFox. The Center frequency is set automatically.

How to change frequency step size

When using the **▲▼** arrows to change any of the frequency settings, the size of the frequency step can be changed.

- Press **Freq/Dist**
- Then **More**
- Then **CF Step Auto Manual**
 - **Auto** Each press of the **▲▼** arrows increments or decrements the value by 1/10th (one division) of the current frequency span. **Note:** To change this setting from **Manual** to **Auto**, press **CF Step** twice.
 - **Manual** Type a step size value using the numeric keypad, then select a multiplier key. Learn more in **“Multiplier Abbreviations” on page 41**.

Radio Standard

A Radio Standard is a collection of settings that are applied to the FieldFox for specific RF protocols. When a Radio Standard is applied, the FieldFox frequency and channel settings change to that of the standard.

By default, the FieldFox locates the center frequency of the standard in the middle of the screen and sets the frequency span to cover all of the Uplink and Downlink frequencies. The selected Radio Standard name appears in the center of the screen below the X-axis.

After a Radio Standard has been selected, the frequency range can be changed by selecting channel numbers rather than frequency. Learn how in [“How to set Frequency Range” on page 146](#).

When a Channel Measurement is selected such as ACPR, other relevant settings will be changed such as Integration BW. Learn more about Radio Standards and Channel Measurements in [“Radio Standards and Channel Measurements” on page 191](#).

How to select a Radio Standard

- Press **Measure 1** OR **Freq/Dist** then **More**
- Then **Radio Standard**
- Then **Radio Standard**
- Then select a standard using the **▲▼** arrows or rotary knob and press **Enter**.

Custom Radio Standards

Your own custom Radio Standards can be imported into the FieldFox. Custom standards are created in *.csv (spreadsheet) format.

A template and instructions for creating your custom Radio Standard is at: <http://na.support.keysight.com/fieldfox/help/SupHelp/Reference/CustomRadioStandard.htm>

Once imported, the *.csv file is stored in the FieldFox \User Data\ folder. The custom Radio Standards are read and presented at the top of the list of internal Radio Standards.

How to Import and Delete a Custom Radio Standard

First, press **Save/Recall** and select the **Device** from which the Radio Standard will be read. Most likely this will be **USB** or **SD Card**.

- Press **Measure 1** OR **Freq/Dist** then **More**
- Then **Radio Standard**
- Then **Radio Standard**

- Then **Import Radio Standards**
- Then select the *.csv file using the **▲▼** arrows or rotary knob and press **Enter**.
- Custom Radio Standards can be removed from the FieldFox by selecting **Measure 1** then **Radio Standard** then **Delete Radio Standard**.
- Then select the *.csv file to delete using the **▲▼** arrows or rotary knob and press **Enter**.

NOTE

To overwrite a custom standard that is already uploaded to the FieldFox, you must first delete the *.csv file from the FieldFox, then re-upload the file that contains the standard. A predefined internal standard (such as GSM 450) can NOT be deleted from the FieldFox.

Channel Selection

After a Radio Standard has been selected, the frequency range can be changed by selecting channel numbers rather than frequency. Once enabled, the channel number is appended to the X-axis frequency range.

How to Enable Channel selection

- Press **Freq/Dist**
- Then **More**
- Then **Unit Freq Chan**

With Unit = **Chan**, **Channel Direction** becomes available and **CF Step** alters to **Channel Step**.

How to change the Channel Number of the Measurement

With Unit = **Chan** the FieldFox will NOT allow you to specify channels outside of the selected Radio Standard.

- Press **Freq/Dist**
- Then choose from the following:
 - **Center Channel** Places the center frequency of the specified channel in the middle of the X-axis.
 - **Start Channel** Places the lowest frequency of the specified channel at the beginning of the X-axis.
 - **Stop Channel** Places the highest frequency of the specified channel at the end of the X-axis.
 - **Freq Span** Changes the span of frequencies while the center frequency remains unchanged.

- Follow each of the above settings by entering a value using the numeric keypad or the rotary knob.
- Use the **▲▼** arrows to increment the channel number by an amount specified by the Channel Step value (see below).
- Then press **Enter** or **Enter**.

Select either Uplink or Downlink Frequencies

Press **Freq/Dist** then **More**. Press **Chan Direction** to toggle between **Uplink** and **Downlink**. If either of these selections is not available, then the selected Radio Standard does not contain those frequencies. In that case, **Chan Direction** is grayed out.

Channel number X-axis annotation

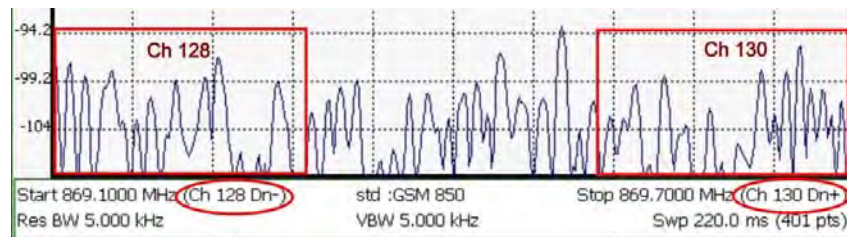

- **Dn** indicates **Downlink** channels.
- **Up** (not shown) indicates **Uplink** channels
- **(-)** indicates that the lowest frequency in the channel (128) is at the left edge of the screen.
- **(+)** indicates that the highest frequency in the channel (130) is at the right edge of the screen.
- When Center Channel or Freq Span is specified, the X-axis shows the Center Freq (Channel) and Frequency Span.
- When Start or Stop Channel is specified, the X-axis shows the Start Freq (Channel) and Stop Freq (Channel).

Change Channel Step Size (Optional)

This setting allows you to use the **▲▼** arrows to increment the channel number by the specified value. The **Channel Step** softkey appears only when it is valid. Learn how to make it valid in the section, “See How to change the Channel Number of the measurement”?

- Press **Freq/Dist** then **More**.
- Press **Channel Step**
- Enter a step value using the numeric keypad, the **▲▼** arrows, or the rotary knob. Then press **Enter**.

Reverse Swap

Available ONLY with Opt. 209 and while in Step sweep mode. Each press of the softkey causes the Start and Stop frequencies to swap. The Start becomes the Stop and vice versa. Learn more about Step versus FFT sweeps in **“FFT Gating (Opt 238)” on page 172.**

- Press **Freq/Dist** then **More**.
- Then **Reverse Swap**

Scale and Units

Adjust the Y-axis scale to see the relevant portions of the data trace.

The Y-axis is divided into 10 graticules. A acquisition is shown on the screen as a solid horizontal bar that can be placed at any graticule.

When RF Attenuation set to **Auto**, the RF Attenuation is coupled to acquisition.

How to set Scale

Press **Scale / Amptd**. Then choose from the following:

- **Scale Type [current setting]**
 - **Log** Logarithmic scale (default setting). The Y-axis reference line represents the specified absolute acquisition in the current Unit selection. Y-axis graticules show dB below or above the reference line.
 - **Lin** Linear scale. The Y-axis reference line represents the specified absolute acquisition in the current Unit selection. Y-axis graticules show percent of acquisition (%) below or above the reference line.

Manually set Scale, acquisition, and Reference Position.

- Press **More**, then **Autoscale** Automatically adjusts the Y-axis to comfortably fit the Minimum and Maximum amplitude of the trace on the screen.
- **Scale** Manually adjust the scale per division to view specific areas of the current trace. Enter a value using the numeric keypad, the **▲▼** arrows, or the rotary knob. Then press **Enter**.
- **Ref Level** Manually set the value of the reference line. Enter a negative value by pressing **Run/Hold (+/-)** either before or after typing a value. This can also change the RF Attenuation setting. See **“Attenuation Control” on page 152.**
- **Ref Pos** Manually set the position of the reference line. Values must be between 0 (TOP line) and 10 (BOTTOM line). Default position is zero (top).

How to Set Y-axis Units

The Unit setting appears for the reference line, marker readouts, and trigger level. All Unit choices are available in both Log and Linear Scale Types.

The UNIT setting survives Mode Preset, but NOT Preset.

- Press **Scale / Amptd**, then **More**, then **Unit**
- Then choose from the following:
 - **dBm** (default setting), **dBmV** (dB milli Volts), **dBuV** (dB microVolts), **W** (watts), **V** (volts), **A** (amps), **dBmA** (dB milliAmps), **dBuA** (dB microAmps).

Antenna correction units are available ONLY by loading or editing an Antenna file that contains the desired units setting. Learn more In.

External Gain

When using an external amplifier or attenuator, the SA mode trace amplitude values can be offset to compensate for the effect of the external device. This effectively moves the reference plane of the SA measurement port out to just beyond the external device. For example, when using an external preamp with gain of +10 dB, enter this value for External Gain, and the data trace across the displayed frequency span will be adjusted down by 10 dB.

When RF Atten is set to Auto, you may see a change in the RF Attenuation value. This is an attempt to measure the signal at top of screen (the acquisition) without overloading the SA first mixer.

How to Set External Gain

- Press **Scale/Amptd**.
- Then **More**
- Then **External Gain**
- Enter a value using the numeric keypad, the **▲▼** arrows, or the rotary knob (positive for gain; negative for loss). Values less than 5 dB must be typed using the numeric keypad. Then press **Enter**

ExtGain xx dB is shown at the top of the screen.

Attenuation Control

Both the RF Attenuation and Preamp functions control the power level into the SA.

When too much power is present at the RF Input port, **ADC Over Range** appears on the FieldFox screen. This does not necessarily mean that damage has occurred, but that the measurement is probably compressed.

When high power levels are present at the RF Input port, internal attenuation can be switched in to keep the FieldFox receiver from compressing. At extremely high power levels, use external attenuation to protect the internal circuitry from being damaged.

CAUTION

The FieldFox can be damaged with too much power.

RF Damage Level: +25 dBm (N995xA & N996xA) and +27 dBm (all others)

DC Damage Level: ± 50 VDC

The displayed power level is automatically adjusted for RF Attenuation. As the attenuation value changes, the displayed power level should NOT change.

How to set Attenuation

- Press **Scale/Amptd**.
 - Then **RF Atten Auto Man**.
 - **Auto** RF Attenuation is set by adjusting the acquisition. As the acquisition is lowered, for example from -10 dBm to -30 dBm, the FieldFox assumes that you are looking at low-level signals. The RF Attenuation value is automatically lowered in 5 dB steps to allow low-level signals to be viewed. The RF Attenuation value is never automatically lowered below 5 dB.
 - **Man** RF Attenuation is set manually. The default Attenuation setting is 10 dB. Enter a value between 0 to 30 dB in 5 dB steps using the numeric keypad, the **▲▼** arrows, or the rotary knob. Then press **Enter**.
- #Atten xx dB is shown at the top of the screen. (#) means manual setting.

Preamplifier Control (Opt 235)

When **very low-level** signals are analyzed, an internal preamplifier can be used to boost the signal level by approximately 22 dB. The gain of the preamp is NOT adjustable. The displayed signal level is automatically adjusted for the increase in system gain.

How to control the Preamp

By default, the preamp is OFF.

- Press **Scale/Amptd**.
- Then **Preamp ON OFF**. The underlined setting is the current setting. When ON, **PA** is shown to the left of the graticules on the display.

Check for Compressed Measurements

Compression occurs when too much power into an amplifier causes it to no longer amplify in a linear manner. When too much power goes into the FieldFox RF Input connector, the amplifiers in the SA receiver compress and

signal power will not be displayed accurately. This can occur even if **ADC Over Range** is not displayed because devices other than the ADC, such as the mixer, might be compressed. Increase the RF Attenuation value to prevent the SA receiver from being compressed.

How to Check for a Compressed Measurement

- Using a marker at the signal peak, make note of the signal power level.
- Increase the RF Attenuation level by 5 dB.
 - If the signal level does NOT change, then NO compression exists. This indicates that the signal is in the linear region of the FieldFox receiver.
 - If the signal level DOES increase, then the receiver was compressed. Set the RF Attenuation value at the setting when further increases no longer result in an increase in the displayed power level.

Field Strength Measurements

To measure the strength of any signal transmitted through the air, an antenna must be connected to the FieldFox. The Field Strength feature allows you to enter the frequency response of the receiving antenna (the Antenna Factor) and associated cabling, and then have amplitude corrections automatically compensate the displayed trace for that response.

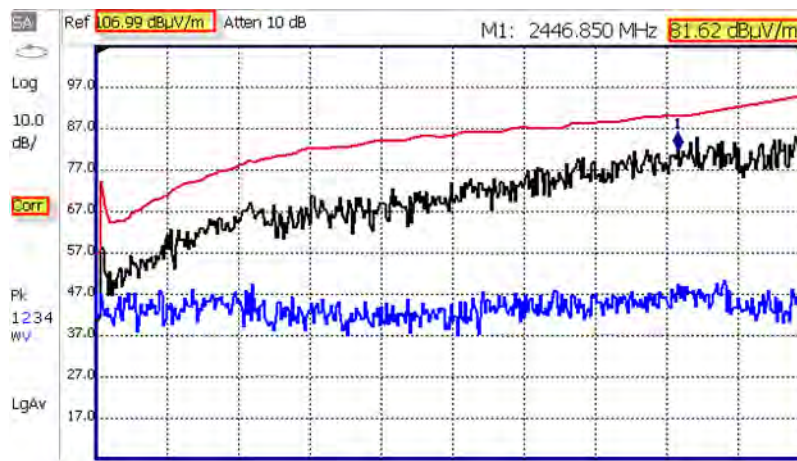

Field Strength Measurements

Trace 1 - Corrected trace with antenna factor. (Antenna = ON, Apply Corr = ON)

Trace 2 - Uncorrected trace (Apply Corr = OFF). The Trace 2 trace state is "View." For information, refer to ["Trace Display States \(SA Mode\)"](#) on page 175

Pink Trace - Current correction factor. See below.

- Learn how to set Y-Axis **Units** on ["How to Set Y-axis Units"](#) on page 152.

- Use a Band Power marker to measure total power over a range of frequencies. Learn how in [“Band/Interval Power Marker” on page 187](#)

How to select and edit corrections for Field Strength measurements

The Antenna and Cable correction data survives a Mode Preset and Preset.

All Correction ON/OFF states survive a Mode Preset, but NOT a Preset.

- Press **Scale/Amptd**.
- Then **More**
- Then **Corrections**
- Then choose from the following:
 - **Apply Corrections ON OFF** Turn ON and OFF correction for all settings.
 - **SrcSide Antenna Off / On** Edit/Recall an Antenna file to be used to transmit.
 - **RcvrSide Antenna Off / On** Edit/Recall an Antenna file to be used to receive.
 - **SrcSide Cable Off / On** Edit/Recall a Cable file to be used on the Source side.
 - **RcvrSide Cable Off / On** Edit/Recall a Cable file to be used on the Receiver side.
 - **View Corrections ON OFF** Turn ON and OFF Pink Trace - Antenna/Cable corrections. This is a composite of all cable/antenna corrections that are currently applied. Available as a useful visual aid, the zero “dB” level (no net correction) is mapped to appear at the -50 dBm on-screen level.

The following menu appears when any of the above Antenna or Cable softkeys are pressed:

- **Antenna/Cable ON OFF** Turn correction ON or OFF for this Antenna/Cable.
- **Edit Antenna/Cable** Edit an Antenna/Cable Correction table. See Using the Antenna/Cable Editor (below) for more information.
- **New** Create a new Antenna/Cable. See Using the Antenna/Cable Editor (below) for more information.
- **Save Antenna/Cable** Save the modified Antenna/Cable to a file on the specified Storage Device.
- **Recall Antenna/Cable** Read an existing Antenna/Cable file from the specified Storage Device.
- **Storage Device** Choose from: Internal, USB, SD. Learn more about these selections in [“Set File Type and Select Device” on page 503](#).

When finished, press **Back** to return to the previous menu.

Using the Antenna/Cable Editor

The Antenna Editor and the Cable Editor menus are very similar. Both tables include header information, and a Frequency/Value table.

NOTE

In any correspondence or telephone conversation, refer to the product by its model number and full serial number. With this information, the Keysight representative can determine the warranty status of your unit.

Figure 9-2

FieldFox Antenna Editor

Setting	Value
Description	Correction Fa
Freq Interpolation	ILIN
Antenna Unit	dB μ V/m
Frequency	Antenna Factor
26.00000000 MHz	20.000 dB
30.00000000 MHz	17.500 dB

How to use the Antenna/Cable Editor

- Press **New** then **Yes** to clear all data from the existing Antenna or Cable table and reset header information to default settings.
- Then **Edit Antenna** or **Edit Cable** to open the Antenna / Cable Editor.
- Then use the **▲▼** arrows to select a field.
 - To edit header information, press **Edit** then modify the selected field using the FieldFox labeler.
 - **Description**: Enter a description for the antenna or cable correction table. This is NOT the filename used to save the file.
 - **Antenna Unit (Rcvr-side Antennas only)**: Units in which the measurement will be displayed. Select **NONE** (default setting) to select from standard SA Units on the Scale menu. Learn how in **“Scale and Units” on page 151**.
 - Choose from: **dB μ V/m** - (dB micro Volts per meter), **dB μ A/m** - (dB micro Amps per meter), **dBG** (gauss), **dBpT** (tesla).

- Freq Interpolation**: Set to LINear and can NOT be edited.
- To edit Frequency/Value pairs, enter numbers using the numeric keypad, and a frequency suffix when necessary.
 - For both **Cable and Antenna correction**, Positive numbers indicate loss (we need ADD something positive to compensate for it), and Negative is indicative of some existing gain.
 - Antenna Factor** describes the dB value needed to accurately display a far-field signal in terms that are in the units listed below. When the antenna has low gain, or low efficiency, the dB value to be added is larger.
- When one Freq/Value pair is entered, that correction value is applied to the entire displayed frequency span.
- When two or more Freq/Value pairs are entered, the data points between the lowest and highest frequencies are corrected. Linear interpolation is applied between frequencies when necessary.
- Optionally choose from the following:
 - Previous / Next Page** Quickly scrolls through pages of Freq/Value data.
 - **Add Row** Add a blank Freq/Value pair to the table,
 - Delete/Clear** then:
 - Delete Row** Remove the selected Freq/Value pair from the table.
 - Clear All** then **Yes** Remove all Freq/Value pairs from the table and resets header information to default settings.

When the table edits are complete

- Press **Done** to close the Antenna/Cable Editor.
- Press **Save Antenna** or **Save Cable** to save your changes to the specified Storage Device. Enter a filename using the FieldFox labeler (learn more in “**How to use the FieldFox labeler ” on page 500**). Learn more about Antenna and Cable files below.
- Press **Recall Antenna** or **Recall Cable** to load an Antenna or Cable file from the specified Storage Device.
- **Storage Device** Changes the device used to save or recall files. Choose from Internal (default setting), USB (must be connected) or SD card. This is a different setting from the Save/Recall Storage Device setting.

About Antenna and Cable files

- Cable files are saved and recalled from the **Cables** folder.
- Antenna files are saved and recalled from the **Antenna** folder.

SA (Spectrum Analyzer) Mode SA Mode Settings

- To **DELETE** Cable or Antenna files, use the Manage Files feature. Learn more in **“Manage Files” on page 506**.
- If the folder does not already exist on a USB or SD card, it is created automatically before storing the file.
- All SA mode Antenna and Cable files are saved and recalled as *.csv files, which allows them to also be read by spreadsheet programs.
- The FieldFox can also read *.ANT (Antenna) files that were created from older Keysight Spectrum Analyzers.
- SA Mode cable or antenna (*.csv or *.ANT) files can NOT be edited in Data Link software.

How to create a Cable file from an S21 (NA mode) or an Insertion Loss (CAT mode) measurement

1. Measure the S21 or Insertion Loss of a cable. In NA mode, select either LogMag, Linear, or VSWR formats.
2. Use Manage Folders to change the active folder to CABLES. Learn how in **“Manage Folders” on page 508**.
3. While in NA mode, save the measurement as a *.csv file. Learn how in **“How to Save a File” on page 498**.
4. In SA mode, select Corrections, then recall the *.csv file for correction.

Source Tracking Offset and Offset Reversal

This feature requires:

- N991xA and N995xA FieldFox Combination Analyzers to have Options 209, 210, and 233
- N993xA and N996xA Spectrum Analyzers to have Options 209 and 220

Source offset tracking is used to offset the Source frequency from the Receiver frequency by a fixed offset at every tune frequency. This feature is used when the DUT contains a frequency translation device or mixer.

How to set Tracking Offset and Offset Reversal

- On the Receiver unit, press **Meas 1**
- Then **Source**
- Then **Advanced**
- Then choose one or both of the following:
 - **Tracking Offset** Enter an offset value.
 - **OffsetReversal** Determines whether Receiver Freq is added to or subtracted from the Offset Freq.

SA (Spectrum Analyzer) Mode
SA Mode Settings

- **OFF** SourceFreq = Offset + RecFreq. Use to measure Upconverters.
- **ON** SourceFreq = Offset - RecFreq. Use to measure Downconverters. The source sweeps in Reverse direction. Note: The Offset Freq. MUST be larger than the Receiver Stop Freq.

Tune & Listen (AM/FM)

The Tune & Listen feature can be used to identify an interfering AM or FM signal.

The demodulated AM or FM signal can be heard through the internal speaker or through headphones using the 3.5 mm jack located on the FieldFox side panel.

The Tune & Listen tuner is separate from the SA display. This allows you to listen to one frequency while displaying a different range of frequencies. The Tune & Listen measurement alternates between normal SA sweeps for the display and performing audio demodulation at the Tune Frequency. See the Listen Time setting for more information.

Figure 9-3 Tune & Listen ON

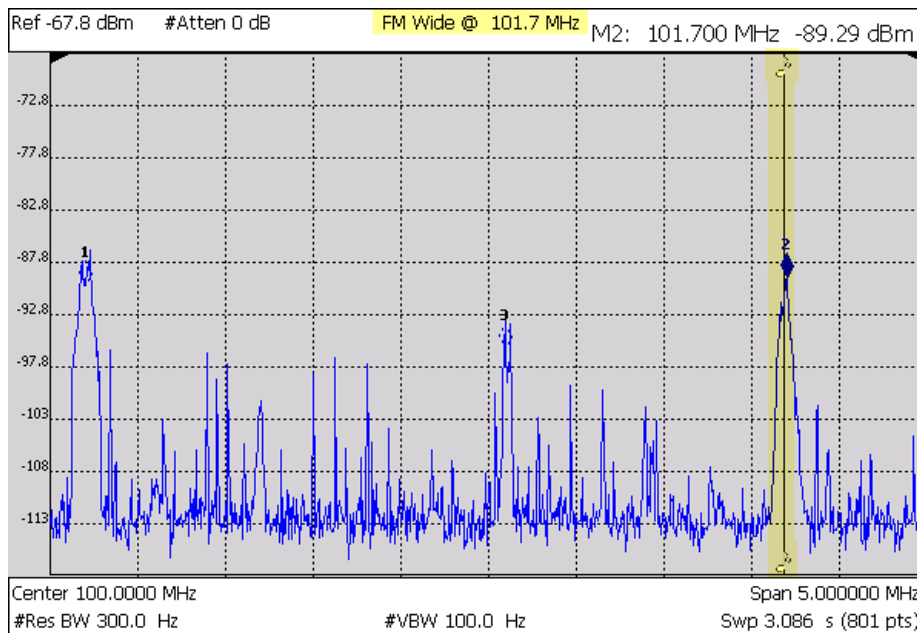

In the graphic above, Tune & Listen ON with Tune Frequency is indicated by a vertical bar (highlighted).

How to select Tune & Listen

- Press **Measure 1**

- Then **Tune & Listen**
- Then choose a demodulation type. Select a setting based on the type of interfering signal you suspect is being broadcast.
 - **None** Turns Tune & Listen OFF
 - **AM** Amplitude Modulation
 - **FM Narrow** Frequency Modulation; Narrow bandwidth. Choose when interfering transmission consist of voice or data.
 - **FM Wide** Frequency Modulation; Wide bandwidth. Choose for high quality music transmissions of FM broadcast radio.

Tune Frequency

The Tune & Listen tuner is separate from the SA display. This allows you to listen to one frequency while displaying a different range of frequencies.

Set the Tune Frequency using one of three methods:

1. Selecting Preset, Mode Preset, or Meas Preset sets Tune Frequency to 3.0 GHz.
2. Specify Tune Frequency:
 - Press **Meas Setup 4**
 - Then **Tune Freq**
 - Enter a value using the numeric keypad, **▲▼** arrows, or the rotary knob. Then select a multiplier key. Learn about multiplier abbreviations **“Multiplier Abbreviations” on page 41.**
3. Using Mkr->Tune Freq:
 - Create a normal marker at the frequency of interest. Learn how in **“How to create Markers” on page 438.**
 - Press **Mkr->/Tools**
 - Then **Mkr->TuneFreq** to change the Tune Frequency to that of the marker.

NOTE

To improve sound quality, try increasing power by reducing the Attenuation setting and, if available, turn ON the Preamplifier. Learn how in **“Attenuation Control” on page 152**

Listen Time

While Tune & Listen is actively demodulating a signal, the SA does not sweep and update the display. Listen Time sets the amount of time that the FieldFox demodulates, then stops to perform a single sweep and update the display, then again demodulates.

To select Listen Time:

- Press **Meas Setup 4**
- Then **Listen Time**
- Enter a value using the numeric keypad, **▲▼** arrows, or the rotary knob. Then select a multiplier key. Learn about multiplier abbreviations.

Volume Control

To increase or decrease the Volume of the demodulated signal:

- Press **Meas Setup 4**
- Then **Volume**
- Enter a value in percent between 0 and 100 (loudest) using the numeric keypad, **▲▼** arrows, or the rotary knob.
- Volume can also be changed and easily muted from the **System** menu. Learn more in [“How to set the FieldFox Volume Control” on page 466](#).

Demod ON and OFF

To quickly stop the audio demodulation and perform only the normal SA sweeps, select the following:

- Press **Meas Setup 4**
- Then **Demod ON OFF**

Independent Source/Tracking Generator

NOTE

For best results, when using the independent source feature, InstAlign and the battery saver features should be turned off. Refer to [“How to Access Individual Alignments” on page 181](#) and [“Preferences” on page 469](#).

This feature may require an option. For a comprehensive list, view the FieldFox Configuration Guide at:

<http://literature.cdn.keysight.com/litweb/pdf/5990-9836EN.pdf>

A tracking generator, a popular option with Spectrum Analyzers, is a source which always tracks the SA receiver.

Like a traditional tracking generator, the Independent Source feature can set the internal FieldFox source to track the SA receiver frequency range. It can also set the internal source to a CW frequency that is independent of the SA frequency.

Independent Source can be enabled ONLY when the FieldFox is in SA mode.

To view the internal source, you must connect a cable or device between the RF Output connector and the RF Input connector.

How to make Independent Source Settings

- Press **Measure 1**
- Then **Source**
- **Source Enable ON OFF**
 - **ON** Turns ON the internal source.
 - **OFF** Turns OFF the internal source.
- **Source Mode** Choose from the following:
 - **Tracking** The internal source frequency can track the SA receiver. Center frequency **Src** is annotated on the screen
 - **CW** The source is set to a CW frequency independent from the SA settings. **Srcw** is annotated on the screen.
 - **Coupled CW** The source is set to a CW frequency, but that frequency “tracks” the SA receiver Center Frequency settings. Therefore, the signal always appears at center of the display. **Srcp** is annotated on the screen.
- **Normalize ON OFF** With Source Enable ON and Source Mode = Tracking, Normalize ON stores the current measurement trace into Trace 4 in View state as a reference trace. All subsequent trace measurements subtract this Trace 4 reference trace, and therefore become relative to it. **SrcN** is annotated on the screen. Normalize is automatically turned OFF when the frequency range or Resolution is changed. Learn more about Trace Display States in [“Trace Display States \(SA Mode\)” on page 175](#).
- **Source Power** Sets the source power level. Choose from:
 - **Leveled** Enter a value from -45 dBm to 0 dBm using the numeric keypad, **▲▼** arrows, or the rotary knob¹. The source power is reasonably flat across the frequency span.
 - **MAX** The power level is set to the maximum achievable power level at each frequency. This results in the power level NOT being flat across the frequency span.
- **Source CW Freq** Sets the CW frequency that is used when Source Mode is set to CW.

NOTE

By default, the source output will turn off momentarily at the end of each IQA and SA sweep and also every 300 seconds during the InstAlign process.

To cause the source to stay ON at the end of each sweep, turn battery saver OFF. (Learn more in [“How to Access Individual Alignments” on page 181](#).)

1. N995xA/6xA cannot have the Leveled value set lower than -35 dBm.

SA (Spectrum Analyzer) Mode
SA Mode Settings

- Press **System 7**
- Then **Preferences**
- Then **Preferences**
- In the table, select Battery Saver. Press **Edit** then **Battery Saver ON OFF**
To suspend InstAlign: (Learn more in [“How to Access Individual Alignments” on page 181.](#))
- Press **Cal 5**
- Then **Amptd Alignment OFF**

Resolution Bandwidth (Res BW)

In SA Mode, the Res BW provides the ability to resolve, or see closely spaced signals. The narrower (lower) the Res BW, the better the spectrum analyzer can resolve signals. In addition, as the Res BW is narrowed, less noise is measured by the spectrum analyzer ADC and the noise floor on the display lowers as a result. This allows low level signals to be seen and measured. However, as the Res BW is narrowed, the sweep speed becomes slower. See [“Very Long Sweep Times” on page 167.](#)

How to set Res BW

- Press **BW 2**.
- Then **Res BW**.
- Then choose from the following:
 - **Auto** Res BW is coupled to the frequency span. As the frequency span is narrowed, the Res BW is also narrowed providing increased ability to resolve signals.
To change this setting from **Man** to **Auto**, press **Res BW** twice.
 - **Man** Enter a Res BW value using the numeric keypad, the **▲▼** arrows, or the rotary knob. Then press a multiplier if necessary or press **Enter**

The current Res BW setting is shown at the bottom of the screen.

#Res BW x.xx XHz (#) means manual setting.

This setting could impact the accuracy of the measurement. See Specifications in Appendix B.

NOTE

The Res BW setting also affects the Sweep Type setting. Learn how in [“Sweep Type” on page 164](#)

Video Bandwidth (Video BW)

Video BW is a smoothing operation that is performed after measurement data is acquired. The trace data is effectively smoothed so that the average power level of the displayed noise is the same, but the peaks and valleys of adjacent data points are smoothed together. More smoothing occurs as the Video BW is set lower. However, as the Video BW is narrowed, the sweep speed becomes slower.

How to set VBW

- Press **BW 2**.
- Then **Video BW**
- Then choose from the following:
 - **Auto** Couples Video BW to the ResBW in a 1-to-1 ratio.
 - **Man** Enter a Video BW value using the numeric keypad, the **▲▼** arrows, or the rotary knob. Then press a multiplier if necessary or press **Enter**. Setting VBW higher than RBW may smooth the trace.

NOTE

To change this setting from Man to Auto, press Video BW twice.

The current Video BW setting is shown at the bottom of the screen.

VBW x.xx XHz (#) means manual setting.

When the Res BW/Video BW ratio exceeds 10,000, a **Meas UNCAL** warning may appear to indicate that the Video BW filter has reached the maximum capacity for averaging.

Sweep Type

In SA mode, the FieldFox uses two sweep types to process inputs signals. The sweep type that is currently being used (**FFT** or **Step**) is displayed in the lower-left corner of the FieldFox screen.

For a more comprehensive tutorial, see Spectrum Analysis Basics (App Note 150) at <http://literature.cdn.keysight.com/litweb/pdf/5952-0292.pdf>

How to set Sweep Type

- Press **BW 2**.
- Then **Advanced**
- Then **Sweep Type**
- Then choose from the following:

- **Auto** The FieldFox selects the most efficient sweep type based on the Res BW. When Res BW is set to 200 kHz and below, FFT sweep type is selected. Above 200 kHz, Step sweep type is being performed.
- **FFT** The FieldFox uses FFT sweep type regardless of the Res BW.
- **Step** The FieldFox uses Step sweep type regardless of the Res BW. This is useful for capturing impulsive noise that may be generated from nearby electrical equipment.

IF Output

The FieldFox IF (intermediate frequency) can be output for external signal processing. The signal is available from the IF Out connector on the FieldFox right-side panel. See the connector in **“Right Side Panel” on page 36**.

The IF Out signal, centered at approximately 33.75 MHz, is simply a down-converted version of the RF Input signal that is present at the tuned frequency.

While outputting an IF signal, the FieldFox stops performing the InstAlign process. Therefore, the amplitude of traces on the FieldFox screen is NOT accurate and **Meas UNCAL** appears on the screen to indicate this. Learn more in **“Individual Alignments” on page 180**.

Learn more about the IF Output frequencies and bandwidths in the Supplemental Online Help:

<http://na.support.keysight.com/fieldfox/help/SupHelp/FieldFox.htm>

How to select IF Output

The IF Output signal is useful only in Zero Span. Learn more about Zero Span in **“Zero Span Measurements” on page 167**.

At least one sweep must be made in order to tune the FieldFox.

- Press **BW 2**.
- Then **Advanced**
- Then **IF Output Use**
- Then choose from the following:
 - **OFF** No output from the IF Out connector.
 - **Narrow** The IF output signal has approximately 5 MHz bandwidth.
 - **Wide** The IF output signal has approximately 25 MHz bandwidth.

Sweep Acquisition

Available only in non-zero span measurements, when Sweep Acquisition is set to Auto, the fastest sweep rate is achieved while maintaining full amplitude accuracy.

NOTE

For zero span measurements, refer to “Zero Span Measurements” on page 167.

However, you can adjust this setting in order to increase the probability of intercepting and viewing pulsed RF signals.

For example, with **SwpAcquisition set to Auto** a pulsed GSM signal is NOT visible on the FieldFox screen, as shown in a blue trace in the following image.

While watching the trace, increase the SwpAcquisition value until the pulse spectrum rises out of the noise and reaches its maximum level. Increasing the SwpAcquisition value beyond this point only slows the update rate (increases the actual Sweep time readout) but does not improve measurement quality.

Figure 9-4 GSM Signal in Framed Data Format

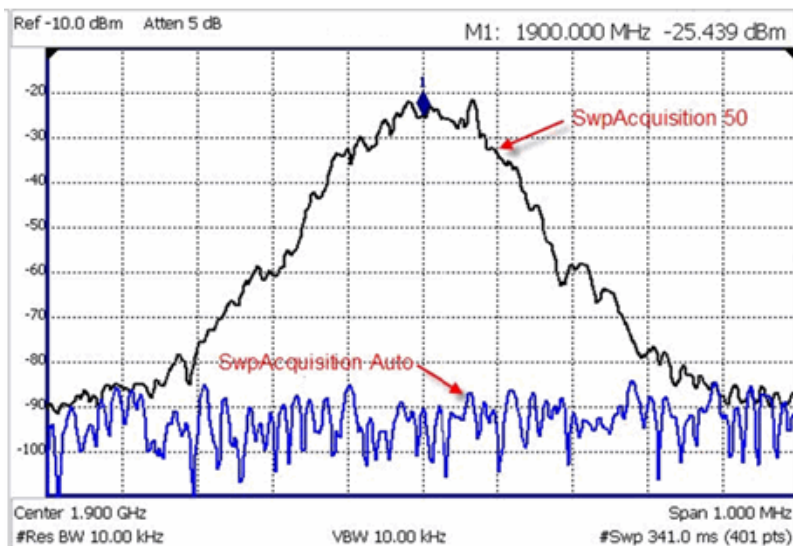

In the graphic above, a GSM signal in a framed data format; timeslot zero ON; all others OFF;

PRF = 218Hz, Duty Cycle = 12.5%. The pulsed signal becomes visible on every sweep update with SwpAcquisition = 50.

How to set Sweep Acquisition

SwpAcquisition is NOT an absolute measure of time, but a relative number between 1 (fastest) and 5000 (slowest) sweep time. The actual time that was required to complete a sweep is annotated on the screen.

- Press **Sweep 3**.

- Then **SwpAcquisition Auto Man**.
- Then choose from the following:
 - **Auto** Sweep is set to the fastest sweep possible with the current settings.
 - **Man** Enter a relative acquisition value between 1 and 5000, where:
 - Man Enter a relative acquisition value between 1 and 5000, where:
 - 1 = Fastest sweep possible
 - 5,000 = Slowest sweep possible
 - # is shown in front of the actual sweep time to indicate a manual setting.

Some Detector and Video Bandwidth settings will raise the Auto Sweep Acquisition value greater than 1. In these cases, manually setting Sweep Acquisition lower than the Auto value may have NO effect.

NOTE

Measurement speed specifications do NOT apply in Temperature Control Mode. Learn more in “Temperature Control Mode” on page 29.

Learn more about SA mode SwpAcquisition time in the Supplemental Online Help: <http://na.support.keysight.com/fieldfox/help/SupHelp/FieldFox.htm>

Very Long Sweep Times

Two primary settings are responsible for the sweep time: Res BW and SwAcquisition.

- When the sweep time exceeds 1200 seconds (20 minutes), an informational message: **Alert: Very long sweep in progress...** is annotated on the screen for the duration of the sweep.
- When the sweep time exceeds 4000 seconds (about 1 hour), **Meas UNCAL** is annotated on the screen. Accuracy cannot be guaranteed.
- InstAlign is always performed only at the beginning of the sweep regardless of the sweep time. Learn more in “How to Access Individual Alignments” on page 181.

Zero Span Measurements

When setting the frequency span to Zero, there is NO spectrum of frequencies to display, so the X-axis units becomes Time. The SA becomes like a tunable oscilloscope, with the center frequency being the frequency of interest. This capability is useful for analyzing modulation characteristics, such as pulsed measurements.

NOTE

For non-zero span measurements, refer to [“Sweep Acquisition” on page 166](#).

Figure 9-5 GSM Signal, Framed Data Format

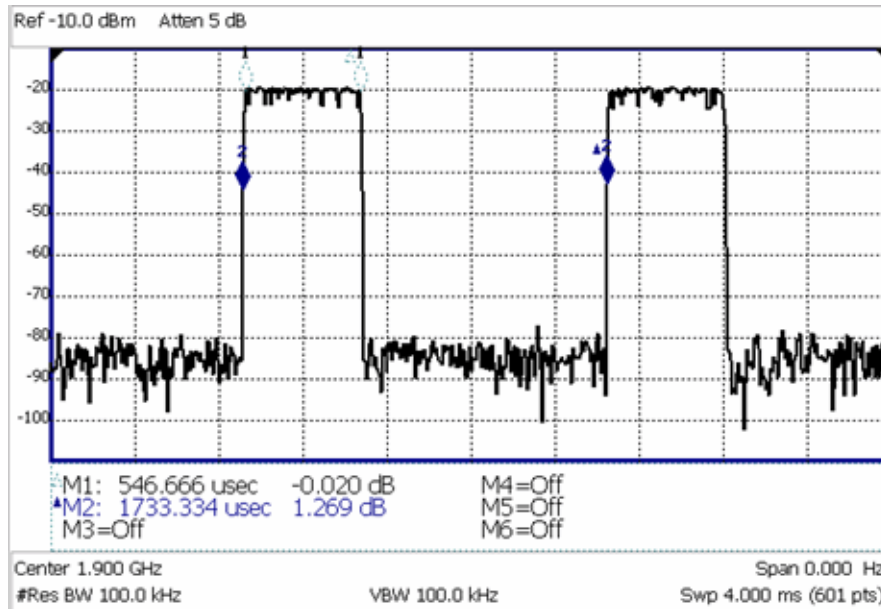

The graphic above shows a GSM signal, framed data format, with timeslot 0 and 3 “on”. Sweep Time is set to approximately the frame interval. Press Single several times until the waveform section of interest is viewable and stable. Then markers can be used to measure the timeslot width and interval as shown.

How to set Zero Span

- Set **Center** to the frequency of interest
 - then set **Span** to 0 Hz
 - or select **Zero/Last Span**. Each key press toggles the frequency span between 0 Hz and the last specified frequency span.

How to change Sweep Time in Zero Span

- Press **Sweep 3**
- Then **Sweep Time**
- Enter a value using the numeric keypad. Sweep time is limited to 1000 seconds for N991xA/2xA/3xA models and 6000 seconds for N995xA & N996xA models.
- Then select a multiplier key. Learn more in [“Multiplier Abbreviations” on page 41](#).

Previous FieldFox versions limited the sweep time / ResBW settings. This restriction is no longer necessary with release A.06.25.

Learn more about SA mode Sweep Time in the Supplemental Online Help:
<http://na.support.keysight.com/fieldfox/help/SupHelp/FieldFox.htm>

Triggering

External, Video, and RF Burst triggering allows you to initiate an SA mode sweep using an external event such as a signal burst.

All three trigger types can be used in either Zero Span (time domain) or FFT frequency sweeps. Learn more in [“Zero Span Measurements” on page 167](#). Learn more in [“Sweep Type” on page 164](#).

FFT Gating is available for non-zero span measurements. Learn more about FFT Gating in [“FFT Gating \(Opt 238\)” on page 172](#).

Trigger Type

- Press **Sweep 3**
- Then **Trigger Settings**
- Then **Trig Type**
- Then choose from the following:
 - **Free Run** Triggering is provided by the FieldFox internal circuitry. A new sweep begins when the previous sweep ends.
 - **External** A sweep is triggered on an external TTL signal at the Ref In/Trig In connector on the FieldFox top panel. Choose to trigger on the rising slope at about 1.7 V or on the falling slope at about 1.0 V using the Trigger Slope setting (below).

The following two selections are similar in that they both trigger a sweep from a signal at the **SA RF Input** connector. Experiment with both selections to find the best trigger type for your application.

- **Video** A sweep is initiated when the displayed amplitude of an incoming signal crosses the settable Trigger Level. This selection can detect low-amplitude signals, but also has been filtered considerably and may not be a true representation of the incoming signal.
- **RF Burst** A sweep is initiated when the signal at the third IF (analog) stage crosses the settable Trigger Level. This selection offers a wider bandwidth and may be a better representation of the incoming signal than Video trigger. However, RF Burst is not as sensitive to triggering on low-level signals.

Trigger Slope

Trigger Slope determines which edge of an External, Video, or RF Burst trigger signal initiates a sweep.

- Press **Sweep 3**
- Then **Trigger Settings**
- Then **Trig Slope**
- Then choose from the following:
 - **Pos** Sweep is triggered by the rising (positive) edge of signal.
 - **Neg** Sweep is triggered by the falling (negative) edge of signal.

Trigger Delay

After a valid trigger signal is received, the sweep begins after the specified Trigger Delay time.

To see the rising edge of a repetitive signal which is triggered on that edge, enter a negative trigger delay value (also known as pre-trigger). Adjust the sweep time to observe the pre-trigger time if necessary.

- Press **Sweep 3**
- Then **Trigger Settings**
- Then **Trig Delay**
- Enter a value using the numeric keypad, the **▲▼** arrows, or the rotary knob.
- Then select a multiplier key or press **Enter**. Learn more in **“Multiplier Abbreviations” on page 41**.

In Zero span, you can use Trigger Position as an easy way to set Trigger Delay by positioning the trigger event on the FieldFox screen. See **“Triggering” on page 169**.

Trigger Level

Used with Video and RF Burst triggering, a sweep is initiated when an incoming signal crosses this level. The units depend on the Units setting. Learn more in **“Scale and Units” on page 151**.

RF Burst Trigger Level uses an alignment process which is performed in the background to set the detected signal level accuracy. Learn more in **“RF Burst Amplitude Alignment” on page 182**. **Video Trigger Level** is a zero span signal level comparison. Therefore, the sweep will trigger close to the displayed level in zero span measurements. In non-zero span measurements, processing can cause broadband signal energy to display at lower power levels than the originating time domain signal. Therefore, you may need to set the trigger level higher than the displayed level.

- Press **Sweep 3**
- Then **Trigger Settings**
- Then **Trig Level**

- Enter a value using the numeric keypad, the ▲▼ arrows, or the rotary knob.
- Then select a multiplier key or press **Enter**. Learn more in **“Multiplier Abbreviations” on page 41**.

Auto Trigger Time

While waiting for a valid trigger signal, **Wait** is annotated in the top left corner of the FieldFox screen.

If a valid trigger signal is not received before the specified Auto Trig Time, a sweep will occur automatically.

Enter **0** to set Auto Trigger **OFF**. When Auto Trigger is OFF, the FieldFox does NOT sweep unless a valid trigger signal is received.

- Press **Sweep 3**
- Then **Trigger Settings**
- Then **Auto Trigger [current setting]**
- Enter an Auto Trig Time using the numeric keypad.
- Then select a multiplier key. See **“Multiplier Abbreviations” on page 41**.

Trigger Position

Available ONLY in zero span measurements, this setting is an easy way to automatically set the Trigger Delay by positioning the trigger event (also known as T-zero) at any graticule along the X-axis. With T-zero in the center of the screen, you can zoom in and out by increasing or decreasing the sweep time. Using the Trigger Position and Sweep Time settings is a quick and efficient way to examine artifacts of a pulse, much easier than trying to set the Trigger Delay manually.

When Trigger Position is set to OFF, the Trigger Delay softkey is not available. The amount of Trigger Delay that is being used is displayed on the softkey. The Trigger Position is annotated on the screen. Learn how in the following section.

- Press **Sweep 3**
- Then **Trigger Settings**
- Then **Trig Position**. If Sweep Time is longer than 0.15 sec, this softkey is grayed out.
 - **ON**: The position of T-zero is set by the trigger delay.
 - **OFF**: Select, then enter a position value from 0 to 10 using the numeric keypad, the ▲▼ arrows, or the rotary knob.
 - **0**: T-zero occurs at the left graticule.
 - **5**: T-zero occurs at the center of the screen.

- **10**: T-zero occurs at the far right graticule.
- Then press **Enter**.

Trigger Settings Annotation

Trigger settings are annotated on the FieldFox screen as highlighted in **red** in the following image:

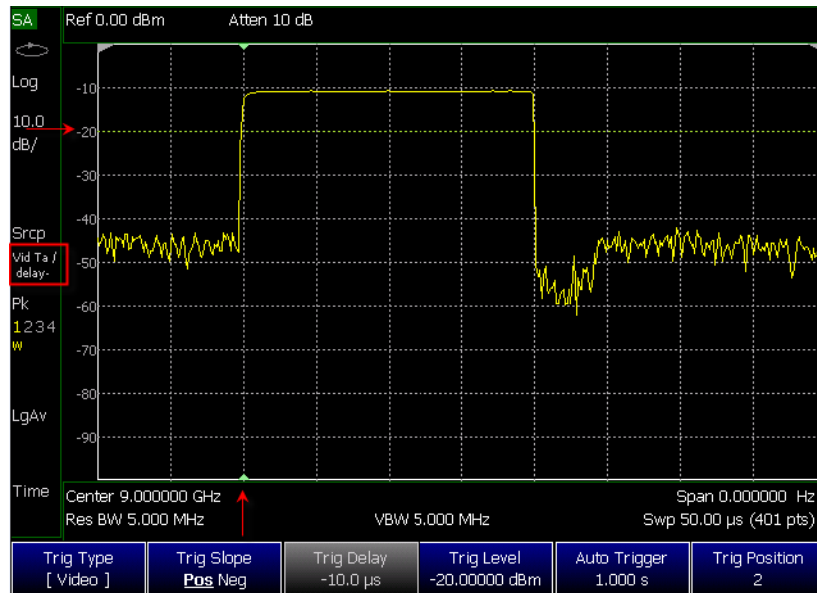

- Square: Trig Type (**VidT**), AutoTrigger (**a**), Pos Slope (**/**), Neg Delay (**delay-**)
- Horizontal arrow: Trig Level (green horizontal graticule at -20 dBm)
- Vertical arrow: Trig Position T-zero indicators (green arrows at 2nd vertical graticule)

FFT Gating (Opt 238)

Time-gated spectrum analysis allows you to obtain spectral information about signals occupying the same part of the frequency spectrum that are separated in the time domain. Using an external trigger signal to coordinate the separation of these signals, you can perform the following operations:

- Measure any one of several signals separated in time; for example, you can separate the spectra of two radios time-sharing a single frequency.
- Measure the spectrum of a signal in one time slot of a TDMA system.
- Exclude the spectrum of interfering signals, such as periodic pulse edge transients that exist for only a limited time.

FFT Gating is a simple, efficient way to set the proper amount of trigger delay and capture time so that signal artifacts of a repeating waveform or pulse can be examined in the frequency domain. Learn more about trigger settings in **“Triggering” on page 169**.

For best results, Auto Trigger should be used with this feature to ensure that the sweep does not wait indefinitely for a trigger. Set Auto Trigger to a time that is longer than the expected periodic rate of the signal. This is especially important when using RF Burst or Video triggering in wider spans, because the signal providing those triggers has limited bandwidth. Learn more about Auto trigger in **“Auto Trigger Time” on page 171**.

For more conceptual information on this topic, please refer to Spectrum Analysis Basics (App Note 150), pages 31 - 35, at <http://literature.cdn.keysight.com/litweb/pdf/5952-0292.pdf>.

How to set FFT Gating

- Create a non-zero span measurement. Wider frequency spans take more time to acquire.
- Press **Sweep 3**
- Then **Trigger Settings**
- Then **FFT Gating Setup**
- Then choose from the following:
 - **Gate View OFF ON** When ON, a separate zero span measurement is displayed below the non-zero span window. The gate view measurement helps to configure the gate width and delay by revealing (with green markers) the location of the gate relative to the trigger event. The zero span measurement is tuned to the center frequency of the non-zero span measurement with about 5 MHz of bandwidth. The Y-axis scale is the same for both windows.
 - **Gate View Time** Set the X-axis span for the non-zero span window. Enter a value using the numeric keypad, the **↔** arrows, or the rotary knob. This value is annotated as Swp (nn) below the window.
 - **FFT Gating OFF ON** When ON, the trigger type, gate width, and delay are applied to the non-zero span measurement. The Res BW is set to a value that is inversely proportional to the gate width.
 - **Gate Width** Set the width of the gating area within the non-zero span window. The gating area is indicated by two vertical green lines. Enter a value using the numeric keypad, the **↔** arrows, or the rotary knob.
 - **Gate Delay** Effectively moves the gating area left (negative delay) or right (positive delay) relative to the trigger event. Enter a value using the numeric keypad, the **▲▼** arrows, or the rotary knob.

When you have properly setup the Gate Trigger, Width, and Delay using the Gate View measurement, you can turn **Gate View OFF** to return to the full screen non-zero span measurement with FFT Gating ON, the RBW set, and the Trigger settings active.

Single / Continuous / Restart

This setting determines whether the FieldFox measures continuously or only once each time the **Single** or **Run / Hold +/-** button is pressed. Use **Hold / Single** or to conserve battery power or to allow you to save or analyze a specific trace.

How to set Single or Continuous

- Press **Sweep 3**.
- Then choose one of the following:
 - **Continuous**
 - **ON** Causes the SA to make continuous sweeps. This is the typical setting for making measurements. Each **Run / Hold +/-** press causes the SA to toggle between continuous sweep and Hold.
 - **OFF** Causes the SA to Hold. Each **Run / Hold +/-** or **Single** press causes the SA to make ONE sweep, then Hold. The Hold annotation changes to an arrow --> while the sweep occurs.
 - **Single** Automatically sets Continuous OFF and causes the SA to make ONE sweep, then Hold.
 - **Restart** Resets the Average counter to 1. The Average counter also is used with MaxHold and MinHold Trace States. Learn more in **“Average Count” on page 176**.

Points

Points is the number of measurements that are displayed along the X-axis. The higher number of data points, the better the ability to resolve closely spaced signals and the slower the sweep speed.

How to set number of points

- Press **Sweep 3**
- Then **Points [current setting]**
- Then choose from: **101 | 201 | 401 | 601 | 801 | 1001**

Trace Display States (SA Mode)

- In SA Mode you can display up to four of the following types of trace states. All SA settings are applied to all displayed traces. See also “[Marker Trace \(IQA and SA Mode\)](#)” on page 442.

A color-coded legend for displayed traces is visible in the left pane of the SA mode screen:

W = Clear/Write; **M** = MaxHold; **m** = MinHold; **A** = Average; **V** = View

How to display the Trace States

- Press **Trace 6**.
- Then **Trace 1,2,3,4** repeatedly to select a trace number to display or change its state. Traces are displayed in the following colors:
 - Trace 1 – **Yellow** Trace 2 – **Blue**
 - Trace 3 – **Orange** Trace 4 – **Green**
- Then **State [current setting]**
- Then choose from the following Trace States:
 - **Clr /Wr** (Clear/Write) Displays the actual measured data for each sweep.
 - **MaxHold** Displays the maximum response of the input signal at each data point over multiple sweeps. See also Average Count in “[Average Count](#)” on page 176.
 - **MinHold** Displays the minimum response of the input signal at each data point over multiple sweeps. See also Average Count in “[Average Count](#)” on page 176.
 - **Average** Each data point is averaged over multiple sweeps as set by the Average Count setting. Learn more in “[Average Count](#)” on page 176.
 - **View** Displays and then holds the last complete measurement trace on the screen. This is similar to storing a trace in memory.
 - **Blank** Displays no trace.
- Press **Default All** to return all traces to their default settings: Trace 1 (Clear/Write); all other traces (Blank).

NOTE

Trace 4 data WILL be overwritten by the FieldFox when using the Independent Source Normalize feature (“[Independent Source/Tracking Generator](#)” on page 161) or using Field Strength antenna or cable corrections (“[Field Strength Measurements](#)” on page 154).

Average Type

In SA Mode, there are four different processes in which Averaging is performed:

- Average Traces – Learn more in [“Averaging” on page 191](#).
- Detection Method Averaging – Learn more in [“Detection Method” on page 184](#).
- Noise Marker Averaging – Learn more in [“Noise Marker” on page 187](#).
- Video BW filtering (for non-Zero Span measurements) – Learn more in [“Video Bandwidth \(Video BW\)” on page 164](#).

There are three types of mathematical averaging that can be performed – Log, Linear, or Voltage (see [“Average Type” on page 176](#)). Select ONE of these types and it is used for all of the above averaging processes.

How to set Average Type

- Press **Meas Setup 4** then **Average Type [current setting]**
- Then choose from the following:
 - **Auto** – The FieldFox chooses the most appropriate type of averaging for the current settings. When Detection Method is set to Average, a Noise Marker is present, or a Channel measurement is active, then Power Average is ALWAYS selected. Otherwise, Log Average is selected.
 - **Log** Averaging – Best for displaying Trace Averaging. LgAv is shown on the left side of the FieldFox screen when selected.
 - **Power** (Linear) Averaging – Best for measuring true power levels. Used in Detection Average and Noise Marker Average. Mathematically, trace noise is 2.5 dB higher than when using Log Average. PAVg is shown on the left side of the FieldFox screen when selected.
 - **Voltage**

Average Count

The Average Count setting is used mainly with the Average Trace State described above. In this Trace State, the Average Count setting determines the number of sweeps to average. The higher the average count, the greater the amount of noise reduction.

When Trace (display) State is set to **Average**, **MaxHold**, or **MinHold**, the average counter is shown in the left edge of the screen below the Average Type.

For all three of these Trace States, when **Sweep 3 Continuous** is set to OFF, press **Restart** to reset the sweep count to 1, perform <n> sweeps, then return to **Hold**.

How to set Average Count

- Press **Meas Setup 4**
- Then **Average Count**
- Enter a value from 1 to 10,000 using the numeric keypad, the **▲▼** arrows, or the rotary knob.
- Press **Enter**

Alignments

NOTE

To better reflect the enhancements implemented during the alignment process, for firmware versions >A.10.15 "IF Flatness Alignment" is now referred to as "Channel Equalization" or "Channel Equalization Alignment" (**ChanEQ Alignment**).

This section contains the following:

- [“Overview” on page 177](#)
- [“All Alignment and Align All Now” on page 179](#)
- [“Individual Alignments” on page 180](#)

Overview

All Alignment or **Align All Now** corrects for receiver drift over temperature and time. SA measurement applications monitor changes in internal temperature and the time since last alignment update and trigger the need for a new update when the alignment becomes stale. The alignment is deemed stale after a significant change in temperature or a significant time elapsed from the last update. The temperature change and time duration necessary to trigger an alignment update is predetermined in the factory. Until the update is performed, annotation indicating “questionable amplitude” is displayed **AMPTD?**.

When **All Alignment** is enabled (by default) the FieldFox performs an alignment process using the internal RF source. Although some sweeps are delayed, measurement results are never disturbed.

If the Independent Source (tracking generator) is enabled for your measurement, it will be borrowed to perform the alignment. Again, the measurement results are not disturbed. Learn about the Independent Source in [“Independent Source/Tracking Generator ” on page 161](#).

The alignment process can be disabled. You may want to do this, for example, if you are analyzing the amplitude stability of a signal.

SA and all modes built on its infrastructure require three types of alignments:

- InstAlign Amplitude Alignment

SA (Spectrum Analyzer) Mode
SA Mode Settings

- RF Burst Amplitude Alignment
- Channel Equalization

These are referred to as **Individual Align**.

All three or a subset of the individual alignments are required for each specific mode, depending on the type of measurement supported by it:

SA:

- InstAlign Amplitude Alignment
- RF Burst Amplitude Alignment

RTSA:

- InstAlign Amplitude Alignment
- RF Burst Amplitude Alignment
- Channel Equalization

Channel Scanner:

- InstAlign Amplitude Alignment

ERTA:

- InstAlign Amplitude Alignment

IQA:

- InstAlign Amplitude Alignment
- RF Burst Amplitude Alignment
- Channel Equalization

Built Power meter

- InstAlign Amplitude Alignment

Default settings and recommended use model for many applications:

- Coupled individual alignments
- Coupled state is Auto
- Individual alignments are not accessible via front panel soft-keys
- Individual alignments cannot be UnCoupled

For special cases, the individual alignments can be accessible via the front panel soft-keys using the Preference setting **SA - Individual Alignment Control > On/Off**. This enables a soft-key for access to **Individual Alignments** when this preference is set to ON: **Cal 5 > Individual Align**. For more refer to **“Preferences” on page 469**, in **Chapter 25** System Settings.

The individual alignments may be:

- Coupled (default) - when they are in the same state, or
- UnCoupled - when at least one of them is in a different state than the other ones
- Executed on demand, all of them, using the **Align All Now** softkey.

Each of the individual alignments:

- could be in one of three states:
 - **Off** - the alignment is not applied and is not updated automatically
 - **Auto** (default) - the alignment will be updated over time and temperature as needed, no user interaction required
 - **Hold** - the unit holds the alignment values from the last alignment-execution and does not execute another alignment automatically
- can be updated on demand using the corresponding **Align Now** soft-key. Refer to **“Individual Alignments” on page 180**.
- The **All Alignment** soft-key has the following functionality:
 - when the individual alignments are Coupled, the state of all of them can be changed simultaneously using the **All Alignment** soft-key sub-menus
 - when the individual alignments are UnCoupled, they will be coupled when using the **All Alignment** soft-key sub-menus and their state will be simultaneously changed accordingly

All Alignment and Align All Now

NOTE

IMPORTANT! It is recommended that you use **Align All Now**, because it includes the individual alignment InstAlign **Amptd Align Now**, as well as, **Burst Align Now**, and **ChanEQ Align Now**. But, if you would prefer to have manual control over the individual alignments, then refer to the **SA Individual Alignment Control** setting in **“Preferences” on page 469**, in **Chapter 25 System Settings**.

The notification **AMPTD?** displayed on screen means the InstAlign amplitude alignment or channel equalization is stale (if its state is Hold) and requires an update or it is in the OFF state. This situation does not occur when the respective alignment is in the Auto state. To clear this notification, press the **Align All Now** softkey.

How to set All Alignment and Align All Now

- Press **Cal 5**

- Then **All Alignment [Auto]** (to enable or disable the All Alignment) – Default is Auto.
- or
- Then **Align All Now** (to manually perform an Align All Now.) This performs an alignment on all three individual alignments: Amptd Align Now, Burst Align Now, and ChanEq Now). Refer to **“Individual Alignments” on page 180**.
- Press **Enter**

If you want to disable the All Alignment [Auto], you can do so in the FieldFox preferences (i.e., you may want to do this, for example, if you are analyzing the amplitude stability of a signal).

Refer to the **SA Individual Alignment Control** setting in **“Preferences” on page 469**, in **Chapter 25** System Settings. See also, Indi.

Individual Alignments

NOTE

IMPORTANT! It is recommended that you use **All Alignment [Auto]** or **Align All Now** in lieu of the individual alignments (**Amptd Align Now**, **Burst Align Now**, and **ChanEQ Align Now**), because All Alignment [Auto] and Align All Now includes the individual alignment InstAlign **Amptd Align Now**, **Burst Align Now**, and **ChanEQ Align Now**. But, if you would prefer to have manual control over the individual alignments, then refer to the **SA Individual Alignment Control** setting in **“Preferences” on page 469**, in **Chapter 25** System Settings.

The Individual Alignment softkey is only available, when the preference **SA - Individual Alignment Control** is set to **On** in the FieldFox Preferences menu. Refer to **“Preferences” on page 469**, in **Chapter 25** System Settings.

How to Access Individual Alignments

This section assumes access to individual alignments was activated using the FieldFox's system settings' Preferences. Once enabled, an **Individual Alignments** softkey is displayed. Refer to "Preferences" on page 469, in Chapter 25 System Settings.

- Press **Cal 5**
- Then **Individual Align**
- Then **Amptd Align Now** or
- Then **Burst Align Now** or
- Then **ChanEq Align Now**
- Press **Enter**

How to make Amplitude Alignment settings

NOTE

During continuous sweep ("acquisition" for IQA) operation, automatic Alignments will NOT interrupt the ongoing measurement, but when necessary, will occur opportunistically as settings are changed. When no automatic alignment updates occur, existing alignments can become stale over time and temperature drift, so a warning annotation on the left panel will light up indicating that alignments need updating.

SA, IQA, RTSA, and other modes use a proprietary amplitude alignment algorithm to make extremely accurate amplitude measurements over the full frequency range of the FieldFox.

These settings do NOT survive a Preset or Mode Preset.

- Press **Cal 5**
- Then **Individual Align**
- Then **Amptd Alignment**
- Then choose from the following:
 - **Auto** (Default setting) Alignments are required and are performed automatically, when necessary, at times when interrupting the RF Output is deemed acceptable. The alignment process is performed opportunistically when changes in settings require the measurement to stop momentarily and a significant time elapsed since the last alignment (predetermined in the factory) or the internal instrument temperature has changed sensibly (predetermined in the factory).

Some examples of the conditions when alignments occur are: This could be a Center frequency change, or it could be as simple as requesting a Single sweep. Also, unique alignments are required at different FieldFox receiver frequency bands, so even if the temperature hasn't changed, an alignment may be required when one changes the Center frequency.

If a needed alignment cannot be performed, the user is notified about questionable amplitude **AMPTD?**

- **OFF** Alignments are not performed. The most recent alignment result is cleared. Only factory corrections are applied to SA Receiver measurements. Questionable amplitude **AMPTD?** is always displayed.
- **Hold** The alignment process is stopped, but the last alignment values are applied to subsequent sweeps.
- **Amptd Align Now** An alignment is performed immediately, thus updating (clearing) any questionable amplitude status. If the Mode was previously Off, it is changed to Hold.

Amptd? is annotated in the lower left corner of the FieldFox screen when amplitude alignment is questionable. This is always true when OFF, and is conditionally true in Auto or Hold when the most recent alignment is deemed stale.

RF Burst Amplitude Alignment

RF Burst alignment calibrates the circuitry to provide accurate external RF Burst triggering. Learn more about RF Burst triggering in [“Triggering” on page 169](#)

When enabled (by default) the FieldFox performs an alignment process using the internal RF source. Although some sweeps are delayed, measurement results are never disturbed.

If the Independent Source is enabled for your measurement, it will be borrowed to perform the alignment. Again, the measurement results are not disturbed. Learn about the Independent Source in [“Independent Source/Tracking Generator ” on page 161](#).

The alignment process can be disabled. You may want to do this, for example, if you are analyzing the amplitude stability of a signal.

How to make Burst Alignment settings

These settings do NOT survive a Preset or Mode Preset.

- Press **Cal 5**
- Then **Individual Align**

- Then **Burst Alignment**
- Then choose from the following:
 - **Auto** (Default setting) SA measurement applications monitor changes in internal temperature and the time since last alignment update and trigger the need for a new update when the alignment becomes stale. The alignment is deemed stale after a significant change in temperature or a significant time elapsed from the last update. The temperature change and time duration necessary to trigger an alignment update is predetermined in the factory.
 - **OFF** The alignment process is NOT performed. Only factory correction values are used.
 - **Hold** The alignment process is stopped, but the last alignment values are applied to subsequent sweeps.

Burst Align Now An alignment is performed once and applied to subsequent sweeps.

Channel Equalization (IQA and RTSA Only)

NOTE

During continuous sweep operation for RTSA and continuous acquisition for IQA, automatic Alignments will NOT interrupt the ongoing measurement, but when necessary, will occur opportunistically as settings are changed. When no automatic alignment updates occur, existing alignments can become stale over time and temperature drift, so a warning annotation on the left panel will light up indicating that alignments need updating. When alignments need updating, you will see a "Channel Equalization" or "ChanEq" error message displayed.

IQA and RTSA modes use proprietary channel equalization algorithms to make extremely accurate channel measurements over the full frequency range of the FieldFox.

How to make Channel Equalization Alignments settings

These settings do NOT survive a Preset or Mode Preset.

- Press **Cal 5**
- Then **Individual Align**
- Then **ChanEq Alignment**
- Then choose from the following:
 - **Auto** (Default setting) SA measurement applications monitor changes in internal temperature and the time since last alignment update and trigger the need for a new update when the alignment becomes stale. The alignment is deemed stale after a significant

change in temperature or a significant time elapsed from the last update. The temperature change and time duration necessary to trigger an alignment update is predetermined in the factory.

Some examples of the conditions when alignments occur are: This could be a Center frequency change, or it could be as simple as requesting a Single sweep. Also, unique alignments are required at different FieldFox receiver frequency bands, so even if the temperature hasn't changed, an alignment may be required when one changes the Center frequency.

- **Hold** The alignment process is stopped, but the last alignment values are applied to subsequent sweeps.
- **OFF** The alignment process is NOT performed, and the channel equalization is deactivated.
- **ChanEq Align Now** An alignment is performed immediately.

The **Amptd?** annotation lights up whenever the current channel equalization is deemed stale.

Detection Method

In SA Mode, the X-axis is comprised of data points, also known as “buckets”. The number of data points is specified using the Points setting. Learn more in **“Points ” on page 174.**

Regardless of how many data points are across the X-axis, each data point must represent what has occurred over some frequency range and time interval.

From the frequency span of the measurement, the span of each data point is calculated as $(\text{frequency span} / (\text{data points} - 1))$. The detection method allows you to choose how the measurements in each bucket are displayed.

Figure 9-6 Detection using One Bucket

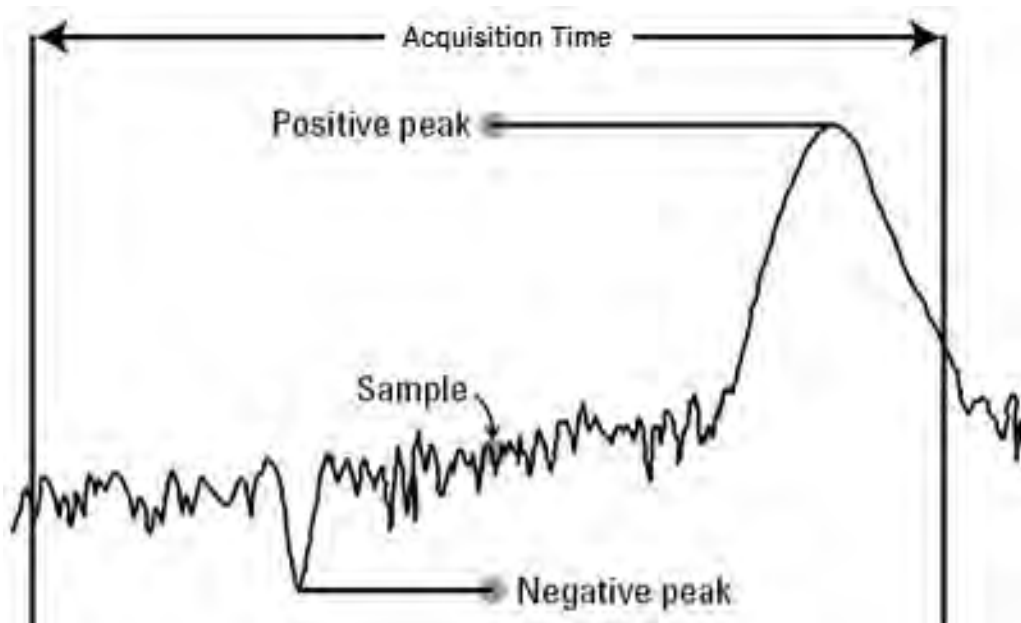

In the graphic above there is one bucket showing Positive peak, Sample, and Negative peak Detection methods.

How to set Detection Method

The current Detection method is labeled on the left edge of the screen. When a method is selected manually, a # precedes the label. For example: **# Nrm** means that **Normal** was selected from the softkeys.

- Press **Trace 6**
- Then **Detector**
- Then choose from the following:
 - **Auto** Displays the most appropriate Detection method based on other settings. [**# is NOT shown**]
 - **Normal** [**#Nrm**] Provides a better visual display of random noise than **Positive peak** and avoids the missed-signal problem of the **Sample** Mode. Should the signal both rise and fall within the bucket interval, then the algorithm classifies the signal as noise. An odd-numbered data point displays the maximum value encountered during its bucket. An even-numbered data point displays the minimum value encountered during its bucket. If the signal is NOT classified as noise (does NOT rise and fall) then Normal is equivalent to Positive Peak.
 - **Positive Peak** [**#Pk**] Displays the maximum value of all the measurements in each bucket. This setting ensures that no signal is missed. However, it is not a good representation of the random noise in each bucket.

- **Negative Peak** [#NPK] Displays the minimum value of all the measurements in each bucket.
- **Sample** [#Smp] Displays the center measurement of all the measurements in each bucket. This setting gives a good representation of the random noise in each bucket. However, it does not ensure that all signals are represented.
- **Average** [#RMS] Displays the Root Mean Squared (RMS) average power of all the measurements in each bucket. This is the preferred method when making power measurements.

Display Line

A display line is a simple, horizontal line that can be placed at any amplitude level on the SA screen or set to any level in IQA. Use a display line as mental guide for visual feedback. A display line is similar to a Limit Line, except that no PASS/FAIL testing occurs. A display line is easier to create than a Limit Line. Learn more in [“All about Limit Lines” on page 453](#).

Figure 9-7 Display Line with Annotations

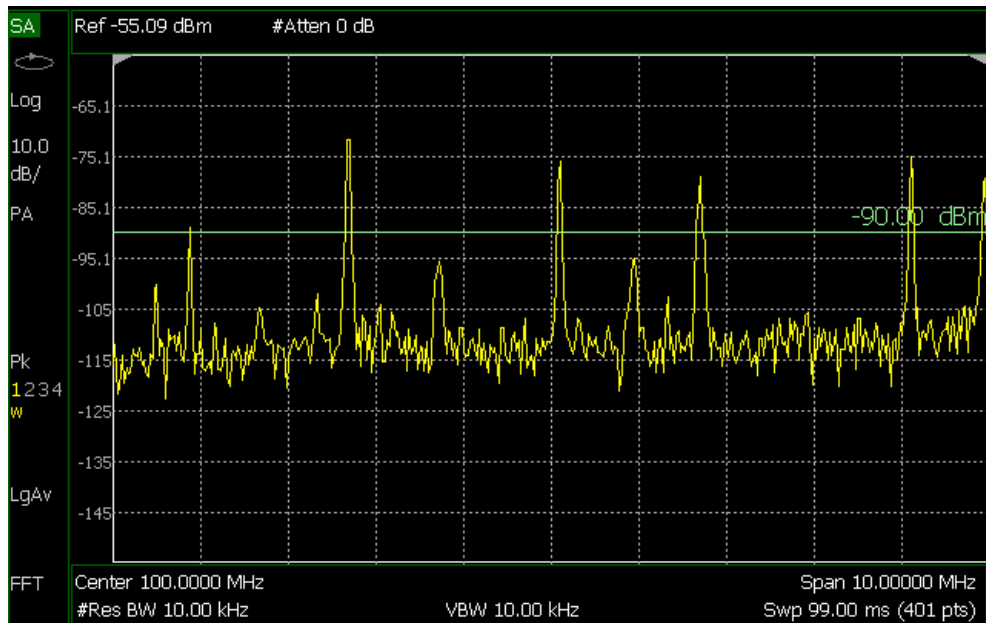

How to create and move a Display Line

- Press **Limit 8**
- Then **Display Line OFF ON**
- Then enter a Y-axis value using the **▲▼** arrows or the rotary knob, then press **Enter**. Or enter a value using the numeric keypad and press a suffix key or press **Enter**.

Noise Marker

For comparison purposes, electronic noise measurements are often displayed as though the measurement was made in a 1 Hz Res BW. However, making an actual measurement at a 1 Hz Res BW is extremely slow.

A Noise Marker, unique to SA Mode, mathematically calculates the noise measurement as though it were made using a 1 Hz bandwidth.

Several data points (or 'buckets') are averaged together to calculate the Noise Marker readout. To accurately measure noise, the Noise Marker should NOT be placed on, or too close to, a signal. The distance from a signal depends on several factors. To know if an accurate reading is being made, move the Noise Marker until consistent measurements are displayed in adjacent data points.

In addition, when a Noise Marker is displayed, the Detection method is automatically switched to Average and **PAvg** is shown on the FieldFox screen. This occurs only when Detector is set to Auto. Learn more in [“Detection Method” on page 184](#).

With a Noise Marker present, the Res BW can be changed and the displayed noise floor will also change, but the Noise Marker readout will remain about the same.

Noise Markers can be used like regular markers. A Noise Marker is distinguished from a regular marker by **(1Hz)** after the marker readout value. Learn more about regular markers in [“All about Markers” on page 438](#).

How to measure Noise with a marker

- Press **Marker** to create or select a Normal or Delta marker to use to measure Noise.
- Then **More**.
- Then **Marker Function**
- Then **Noise ON OFF**.

Band/Interval Power Marker

A Band/Interval Power marker—available in IQA and SA Modes—accumulates the power that is measured over several adjacent data points (or 'buckets'). The range of buckets being measured is displayed with vertical posts around the marker. This Band Span value is selectable.

This feature is very similar to a channel power measurement ([“Channel Power \(CHP\)” on page 192](#)).

When the frequency span is set to Zero span, the marker is referred to as an Interval Band Marker because it averages power over a specific time interval. In this case the range is specified as the Interval Span. Learn more about Zero span measurements in [“Zero Span Measurements” on page 167](#).

If the Detection method and Averaging type are set to Auto when you enable a Band/Interval Power marker, the Detection method will change to Average (RMS) and Averaging type will change to Power average. Other Detection methods or Averaging type settings will usually cause measurement inaccuracy. Learn more about Detection method in [“Detection Method” on page 184](#), and Averaging Type in [“Average Type” on page 176](#).

Summary:

- In Zero span, an Interval Power Marker yields the average power over the specified time interval.
- In non-Zero span, a Band Power Marker yields the total power over the specified frequency range.

How to measure Band/Interval Power with a marker

- Press **Marker** to create or select a Normal or Delta marker to use to measure Band/Interval Power.
- Then press **More**
- Then **Marker Function**
- Then **Band/Int Power**
- Then **Band (or Interval) Span**
- Then choose from the following:
 - **Auto** Measures power over 5% of the displayed span, or ½ graticules. The Band Span is automatically updated to remain at 5% when you change the frequency span.
 - **Man** Enter a frequency or time value using the **▲▼** arrows or the rotary knob, then press **Enter**. Or enter a value using the numeric keypad and select a frequency or time suffix. The Band Span remains at the frequency or time value that you set as the span changes.

Frequency Counter at Marker

- **Available in SA Mode ONLY.** Use any existing marker to make highly-accurate frequency counter readings. For highest accuracy, lock the FieldFox to a stable external frequency reference. Learn how in [“Frequency Reference Source” on page 484](#).

When Frequency Counter is ON, the FieldFox uses background sweeps to zoom on the signal, measure the signal peak with 1 Hz resolution, and display the frequency of the signal peak in the marker annotation area. The marker does not move to the signal peak.

When Freq Counter is ON, measurement sweeps are considerably slower.

How to use Frequency Counter

- Press **Marker**.
- Press Normal, Delta, or Peak, or select an existing marker to use as a frequency counter.
- Locate the marker somewhere on a CW signal. It does NOT have to be on the peak.
- Then **More**
- Then **Freq Count ON**
- With Freq Count ON, you can scroll through the existing markers that are located on a discrete CW signal, and read the frequency of the signal peak. However, each frequency count update requires another sweep. If the FieldFox is in HOLD, press **Single** to update the frequency count results.

Time Zero Fixed Marker

This feature was created to allow recall of vintage instrument states (older than Rev. 7.0) that included Zero span sweep with a trigger delay and at least one marker. Before Rev. 7.0, these instrument states were saved and recalled with the equivalent of the ON state of this setting. The default setting is OFF. Learn more about Triggering with negative delay in [“Triggering” on page 169](#).

- Press **Mkr->/Tools**
- Then **More**
- Then **Mkr Properties**
- Then **Time Zero Fixed**
- Then choose from the following:
 - **ON** Time Zero is fixed at the left-edge of the screen. A marker in negative delay resides at this point. This is the vintage behavior.
 - **OFF** (default) Time Zero is located at the T-zero indicators. A marker in negative delay appears to the left of T-zero.

Audio Beep at Marker Power

When enabled, the Audio Beep feature emits a repetitive beep sound which varies in tone pitch and repetition rate to indicate the relative power level of the active marker. The highest tone pitch and fastest beep rate occurs when the marker Y-axis position is at the top of the display. Conversely, the lowest pitch and repetition rate occurs at the bottom of the display. Therefore, it is important to scale the signals that you intend to measure between the top and bottom of the screen. Learn more about Scale in [“Scale and Units” on page 151](#).

Audio Beep can be used with any marker type or function, including Band/Interval Power. Learn more in [“Audio” on page 474](#).

How to use Audio Beep

- Press **Marker**
- Optionally, press **Marker 1 2 3 4 5 6** to select an existing marker to use with Audio Beep. A marker will be created if one does not already exist.
- Then **More**
- Then **Marker Function**
- Then **Audio Beep ON OFF**

Audio Beep does NOT beep when the FieldFox is in Hold mode.

While Audio Beep is ON, press **Marker 1 2 3 4 5 6** to toggle Audio Beep through the existing markers.

To set FieldFox speaker volume control, press **System**, then **Volume**. Learn more in [“Audio” on page 474](#).

Meas UNCAL Error

Meas UNCAL appears in the lower-left corner of the screen when the FieldFox can NOT display accurate measurement results with the current settings. Usually, the part of the trace that is inaccurate is shown at -200 dB.

The following situation can produce **Meas UNCAL**:

- When the ResBW/VBW ratio exceeds 10,000, causing the VBW filter to reach the maximum capacity for averaging.

Old Data Indicator (*)

In SA mode, when the current trace does not exactly match the annotation that is on the screen, an asterisk is displayed in the upper-right corner of the screen graticule area. This would occur, for example, when the Res BW setting is changed while in sweep Hold mode. The annotation is changed immediately, but the trace is not updated until the next sweep occurs. Therefore, the current data trace does not match the screen annotation. See the asterisk in [Figure 9-1 on page 143](#).

Channel Measurements

The following Channel Measurements are offered in SA Mode:

- Channel Power [“Channel Power \(CHP\)” on page 192](#)
- Occupied Bandwidth [“Occupied Bandwidth” on page 194](#)
- Adjacent Channel Power Ratio [“Adjacent Channel Power Ratio \(ACPR\)” on page 196](#)

Radio Standards and Channel Measurements

To tune the frequency range of any of the Channel Measurements using channels instead of frequency, first select a Radio Standard, then select Units = CHAN. Learn how to select a Radio Standard and channels in [“How to select a Radio Standard” on page 148](#).

When you first select a Radio Standard, then select a Channel Measurement:

- With Units = FREQ selected, the center frequency and span will ALWAYS change to the full frequency range of that standard (Uplink and Downlink) to allow for a quick scan of energy. The X-axis annotation indicates the frequency range.
- With Units = CHAN selected, the FieldFox chooses either the uplink or downlink band, and displays that range of frequencies. You can then tune within that Standard using Start CHAN, Stop CHAN, or Center CHAN. The X-axis annotation indicates the frequency range.

When you **first select a Channel Measurement**, then select a **Radio Standard**, the BW, Offset, RRC, Integration BW, and Span settings are changed to those of the standard. In addition, Res BW can also change when set to ‘Auto(couple)’. However, center frequency is NOT changed unless you first select Units = CHAN.

Measurement Preset

Measurement Preset allows you to easily reset any of the channel measurements to its default settings. The Center Frequency, Preamp ON|OFF, RF Attenuation, Markers, Limits, and Radio Standard settings are NOT reset.

How to select Measurement Preset:

- Press **Preset** then **Meas Preset**

Averaging

By default in ALL Channel measurements, averaging is enabled and set to display the average of the last 15 measurements. When enabled, this average setting is automatically making the following ‘averaging’ settings in order to provide the most accurate power measurements:

SA (Spectrum Analyzer) Mode Channel Measurements

- Averaging Type is set to Power.
- Trace State is set to Average.
- Detector is set to Average.
- Count is set to 15.

Any of these settings can be changed manually during a Channel measurement. Learn more about these settings starting in **“Average Type” on page 176**.

To change Averaging:

- Press **Meas Setup 4**.
- Then **Average Enable ON OFF** OFF effectively sets the Average Count to 1.
- Then **Average Count**
- Enter a value between 1 and 10,000 using the numeric keypad, **▲▼** arrows, or the rotary knob.
- Press **Enter**.

Traces

Only one measurement trace can be displayed in Channel Measurements.

Channel Power (CHP)

Channel Power measures total power over the specified Integrated BW. The Integration Bandwidth (IBW) can be adjusted to measure the power over multiple channels.

Figure 9-8 Channel Power Measurement

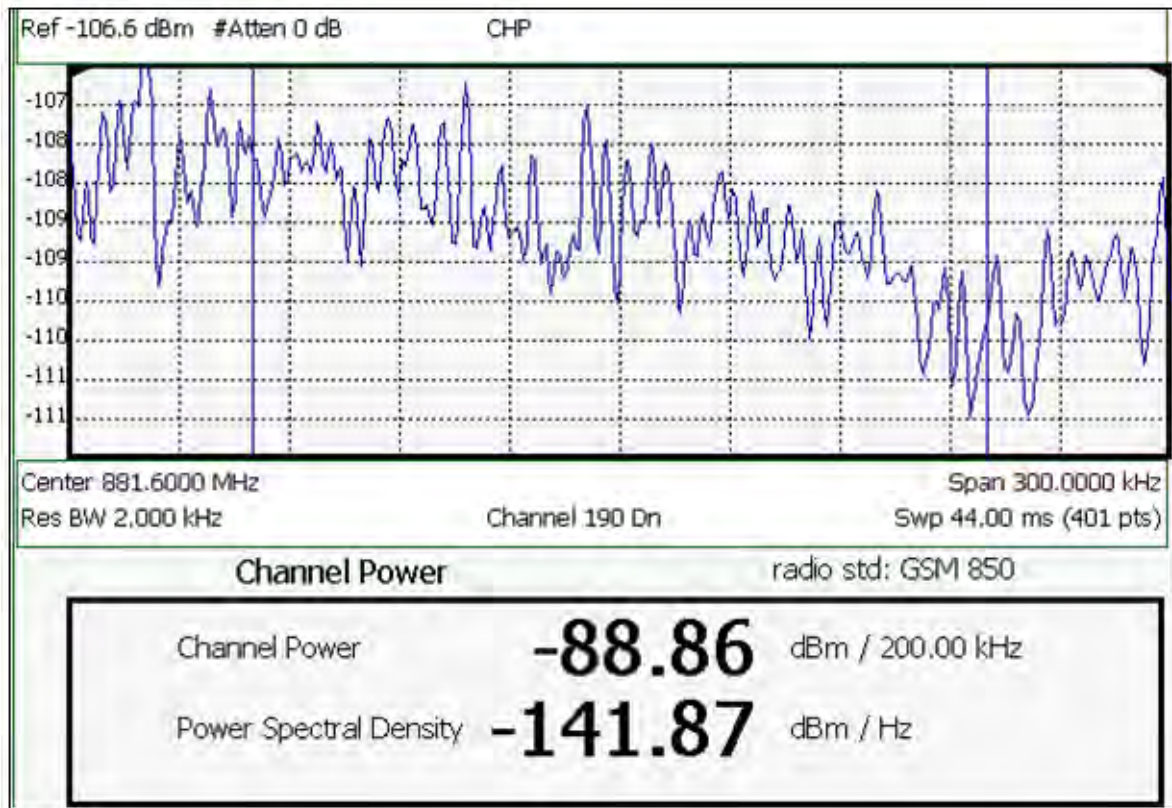

The following two Channel Power levels are displayed:

- **Channel Power** - measures total power over the specified Integrated BW.
- **Power Spectral Density** – same measured power, but mathematically normalized to a 1 Hz bandwidth using the same algorithm as Noise Marker. Learn more about the Noise Marker in [“Noise Marker” on page 187](#).

How to select Channel Power

- Press **Measure 1**
- Then **Channel Measurements**
- Then **Channel Power**

When Channel Power is selected, the following settings are maintained from a previous measurement: Center Frequency, Preamp ON|OFF, and RF Attenuation.

Integration Bandwidth

When Channel Power is selected, vertical posts appear on the display to mark the current Integration Bandwidth setting. The displayed Channel Power and Power Spectral Density values are measured and calculated over the specified Integration Bandwidth.

By default, the displayed frequency span is automatically coupled to the Integration Bandwidth. As you change the Integration Bandwidth, the frequency span is adjusted so that the vertical posts appear to NOT move. However, when you manually change the frequency span, the Integration Bandwidth is no longer coupled to the frequency span.

When a Radio Standard is selected, the appropriate Integration Bandwidth is set automatically. Learn more about Radio Standards in [“Radio Standard” on page 148](#).

To change Integration Bandwidth:

- Press **Meas Setup 4**
- Then **Integrating BW**
- Enter a value between 100 Hz and 3 GHz using the numeric keypad,  arrows, or the rotary knob.
- Press **Enter**

Other Channel Power Settings

All relevant FieldFox settings are made automatically to ensure the highest accuracy, such as ResBW, VideoBW, and sweep (SwpAcquisition) speed. These, and all other SA Mode settings, can be changed manually in a Channel Power measurement.

- Learn about Measurement Preset in [“Measurement Preset” on page 191](#).
- Learn about Averaging in [“Averaging” on page 191](#).
- Learn about RRC Weighting in [“RRC Weighting” on page 200](#).

Occupied Bandwidth

Occupied Bandwidth measures the power of the displayed frequency span and displays vertical posts at the frequencies between which the specified percentage of the power is contained. The frequency span between the two vertical posts is the Occupied Bandwidth. The Occupied Power, the power that is contained between the two posts, is also displayed in dBm.

Figure 9-9 Occupied Bandwidth Measurement

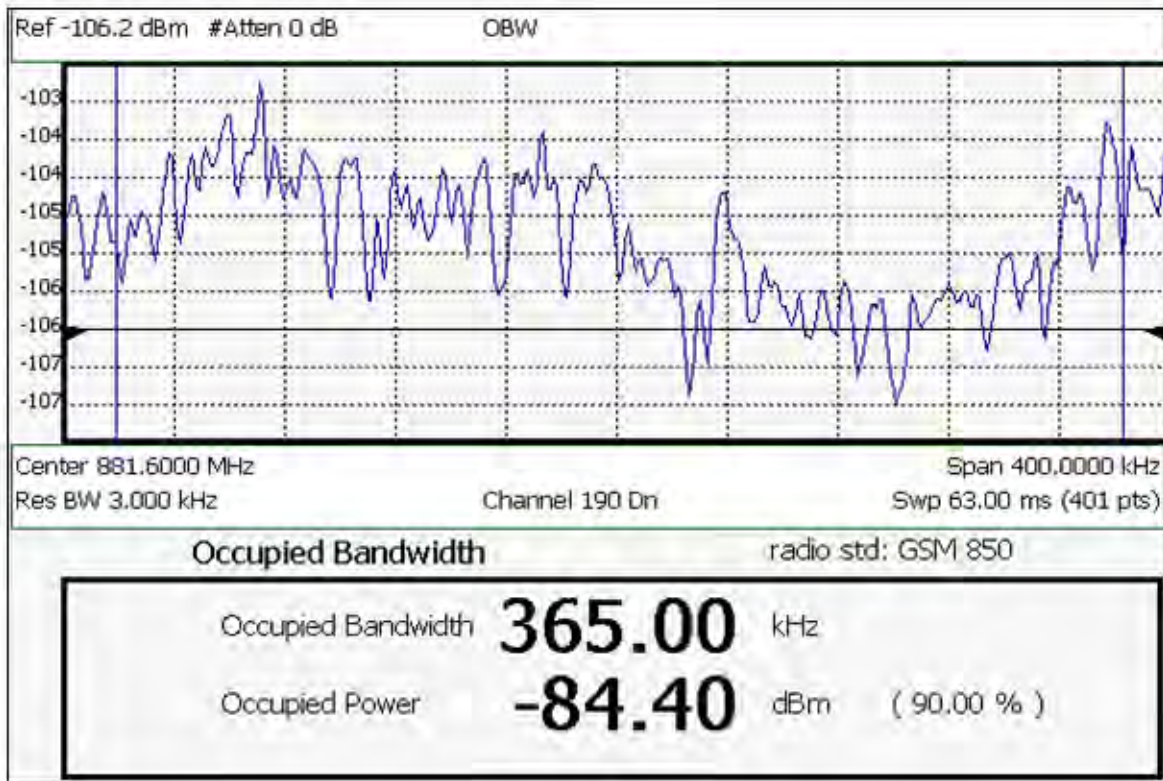

The graphic above shows an OBW measurement; Chan 190 Downlink; GSM850 Radio Standard

How to Select Occupied Bandwidth

- Press **Measure 1**
- Then **Channel Measurements**
- Then **Occupied BW**

When Occupied Bandwidth is selected, the following settings are maintained from a previous measurement: Center Frequency, Preamp ON|OFF, and RF Attenuation.

Frequency Span

Occupied BW is calculated from power that is measured over the entire displayed Frequency Span. The frequency span can be entered using arbitrary frequencies or by using a Radio Standard in conjunction with channel numbers. Learn how to select a Radio Standard and channels in **“Channel Selection” on page 149.**

To change Frequency Span:

- Press **Freq/Dist**

SA (Spectrum Analyzer) Mode Channel Measurements

- Then **Freq Span**
- Enter a value using the numeric keypad, **▲▼** arrows, or the rotary knob.
- Press **Enter**

Power Percent

This setting specifies the percentage of total measured power to display between the vertical posts. The measurement defaults to 99% of the occupied bandwidth power. The remaining power (1% of default setting) is evenly distributed;.5% of the power on the outside of each side of the vertical posts.

To change Power Percent:

- Press **Meas Setup 4**
- Then **Power Percent**
- Enter a value between 10 and 99.99 using the numeric keypad, **▲▼** arrows, or the rotary knob.
- Press **Enter**.

Other Occupied Bandwidth Settings

All relevant FieldFox settings are made automatically to ensure the highest accuracy, such as ResBW, VideoBW, and sweep (SwpAcquisition) speed. These, and all other SA Mode settings, can be changed manually in a Occupied Bandwidth measurement.

- Learn about Measurement Preset in **“Measurement Preset” on page 191**.
- Learn about Averaging in **“Averaging” on page 191**.

Adjacent Channel Power Ratio (ACPR)

ACPR measures the power of a carrier channel and the power in its adjacent (offset) channels. The measurement results can help you determine whether the carrier power is set correctly and whether the transmitter filter is working properly.

You can measure the channel power in one, two, or three adjacent (offset) channels on the low frequency and high frequency side of the carrier channel.

Limits can be used to quickly see if too much power is measured in the adjacent channels.

Figure 9-10 GSM 850-Ch 251-Up with one Offset

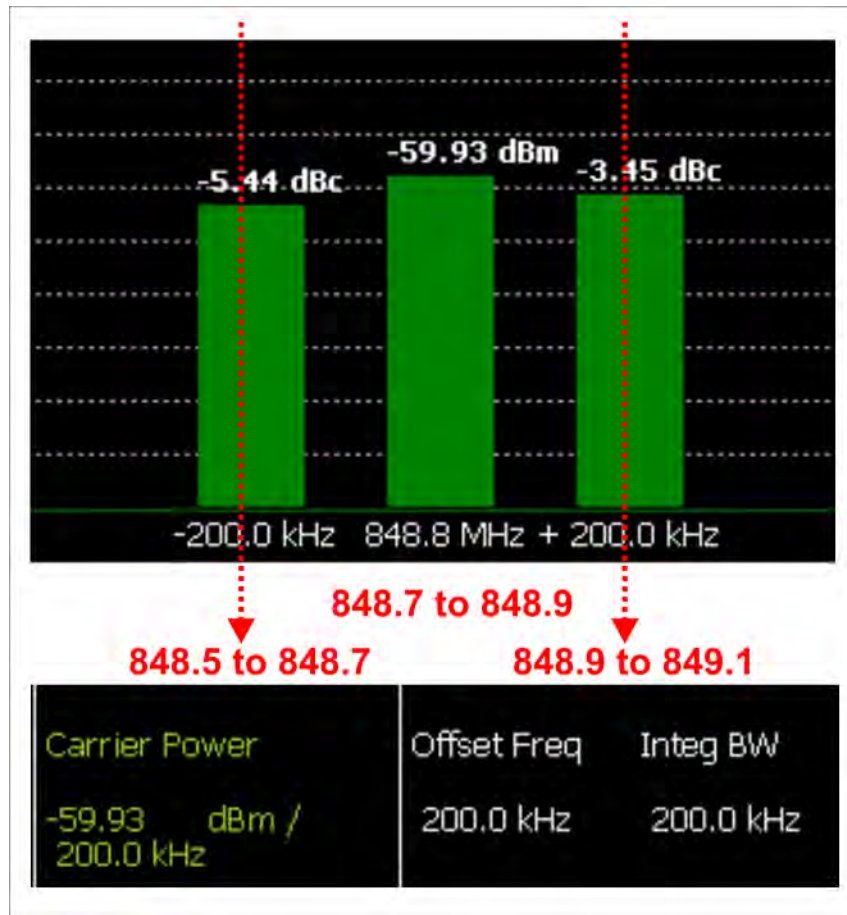

In the graphic above, red frequencies (MHz) are added to illustrate offset and integ BW.

Data in the ACPR graphical chart is always presented in dBm for the carrier, and dBc (dB below the carrier) for the offsets. This can NOT be changed. Use the **Meas Type** setting (next page) to change how the data is presented in the table below the graph.

How to select ACPR

- Press **Measure 1**
- Then **Channel Measurements**
- Then **Adjacent Channel Power**

When ACPR is selected, the following settings are maintained from a previous measurement: Center Frequency, Preamp ON|OFF, and RF Attenuation.

Frequency Range/Channel

When a Radio Standard is selected, the appropriate center frequency or channel and span is set automatically. The frequency or channel number can then be changed from the **Freq/Dist** menu. Learn how to select a Radio Standard and channels in **“Radio Standard” on page 148**.

The frequency range of an ACPR measurement can also be entered using arbitrary frequencies.

When a Radio Standard is NOT selected, the center frequency of a previous measurement is maintained when ACPR is selected.

Integration Bandwidth

The Integration Bandwidth of the carrier and offsets is the frequency span over which power is measured.

To change Integration Bandwidth:

- Press **Meas Setup 4**
- Then **Integrating BW**
- Enter a value between 100 Hz and 100 MHz using the numeric keypad, **▲▼** arrows, or the rotary knob.
- Press **Enter**

How to define adjacent (Offset) channels

An offset represents a difference in center frequencies of the carrier channel and its adjacent channel to be measured. The frequency range for each offset is specified with an Offset Freq and Integ BW. Each offset that is created has a Lower (carrier MINUS Offset Freq) and Upper (carrier PLUS Offset Freq) set of frequencies.

- Press **Meas Setup 4**
- Then **Offsets**
- Press **Offset 1 2 3** to select an offset.
- Then **Offset State** to set that offset ON or OFF.
- Select **Offset Freq** This is the difference between the **carrier center frequency** and the **center frequency of the offset channel**. Then enter a value using the numeric keypad.
- Select **Offset Integ BW** This is the frequency range over which power is measured in that offset; half of the range below and half above the Offset Freq.

How to set limits for adjacent channels

You can set a unique threshold power for each of the offsets that will cause a FAIL indication (RED bar). This occurs when the calculated **dBc** power (on top of the offset bar) is ABOVE the specified level.

To set limits, with an ACPR measurement on the screen:

- Press **Limit 8**
- Then **Offset (1,2,3)**
- Then choose from the following:
 - **LowerOffsetLimit** Sets a limit for the lower-frequency offset.
 - **Upper OffsetLimit** Sets a limit for the higher-frequency offset.
- Then enter a value using the numeric keypad, **▲▼** arrows, or the rotary knob.
- Then **Limit Test ON OFF**

Measurement Type

This setting determines how the measured carrier and offset power levels in the **table** are presented. (Data in the graphical chart is always presented in dBm for the carrier and dBc for the offsets.)

To select Meas Type:

- Press **Meas Setup 4**.
- Then **More**
- Then **Meas Type**
- Then choose from the following:
 - **Total Pwr Ref** – Integrated carrier power is represented in dBm, and relative powers between offsets and carrier are represented as dBc (dB below the carrier).
 - **PSD Ref (Power Spectral Density)** – Integrated carrier power is normalized to a 1 Hz density as dBm/Hz using a similar algorithm as Noise Marker. Learn more about the Noise Marker in **“Noise Marker” on page 187**.

For both Meas Types, choose the reference for the offset data.

- Press **Ref Value** to toggle between these settings:
 - **Auto** – dB or dBc value is computed by subtracting the measured carrier power from the measured offset power.
 - **Man** – dB or dBc value is computed by subtracting the entered RefValue from the measured offset power.

- Then enter a value to be used to reference the data using the numeric keypad,  arrows, or the rotary knob.

Other ACPR Settings

All relevant FieldFox settings are made automatically to ensure the highest accuracy, such as ResBW, VideoBW, and sweep (SwpAcquisition) speed. These, and all other SA Mode settings, can be changed manually in a ACPR measurement.

- Learn about Measurement Preset in [“Measurement Preset” on page 191](#).
- Learn about Averaging in [“Averaging” on page 191](#).

RRC Weighting

RRC, or Root-Raised-Cosign weighting, is offered with Channel Power and ACPR measurements.

When RRC Weighting is applied to transmitted and received power, the edges of the channel are ‘smoothed’ to help prevent interference. To accurately measure a channel that has RRC weighting, set the same value of RRC weighting as that used in the transmitter and receiver.

Figure 9-11 Channel power measurement with .22 RRC applied

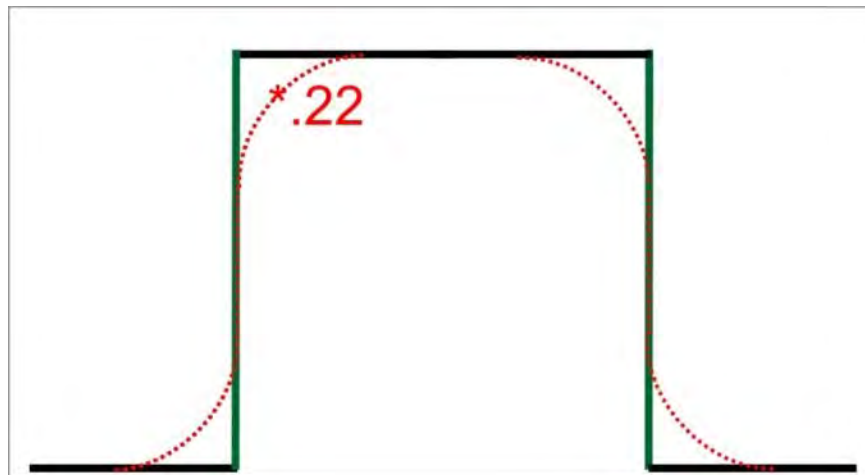

RRC Weighting is set and enabled automatically when included in a selected radio standard.

To set and enable RRC Weighting:

- Press **Meas Setup 4**
- Then **RRC Weighting ON OFF**
- Then **More**
- Then **RRC Alpha [current setting]**

SA (Spectrum Analyzer) Mode
Channel Measurements

- Enter a value between 0 (no smoothing) and 1 (most smoothing) using the numeric keypad,  arrows, or the rotary knob. A standard level of filtering is 22.
- Press **Enter**.

SA (Spectrum Analyzer) Mode
Channel Measurements

10 RTSA (Real-Time Spectrum Analyzer) Mode—Option 350 (CPU2 Only)

RTSA Mode measures signals at the **SA RF IN** connector.

For a comprehensive RTSA mode tutorial, see Understanding and Applying Probability of Intercept in Real-Time Spectrum Analysis (App Note) at <http://literature.cdn.keysight.com/litweb/pdf/5991-4317EN.pdf>

Figure 10-1 RTSA Display using Markers

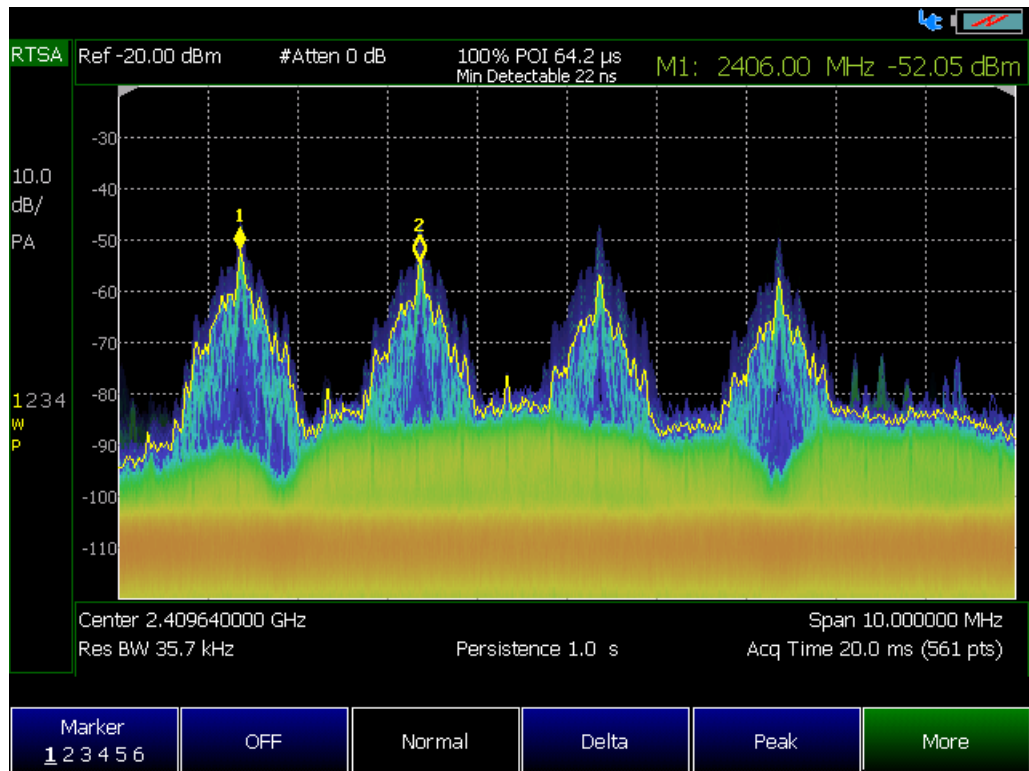

The graphic above shows an RTSA display of a *Bluetooth* signal using markers.

In this Chapter:

[“Frequency Range” on page 205](#)

[“Scale and Units” on page 206](#)

[“External Gain” on page 207](#)

[“Attenuation Control” on page 207](#)

[“Preamplifier Control \(Opt 235\)” on page 208](#)

[“Check for Compressed Measurements” on page 209](#)

[“Resolution Bandwidth \(Res BW\)” on page 212](#)

[“Triggering” on page 213](#)

[“Single / Continuous / Restart / Time Per Div” on page 216](#)

[“Points \(not user settable\)” on page 217](#)

[“Trace Display States” on page 218](#)

[“Average Count, Show Density, Blue, and Red Percentage Limits” on page 220](#)

[“Average Count” on page 221](#)

[“Alignments” on page 221](#)

[“Detection Method” on page 219](#)

[“Display Line” on page 221](#)

[“Spectrogram Display \(RTSA Option\)” on page 223](#)

[“Record/Playback \(RTSA Option\)” on page 225](#)

See Also

Optional Settings:

[“All about Markers” on page 438](#)

[“All about Limit Lines” on page 453](#)

[“Saving and Recalling Files” on page 498](#)

RTSA Mode Settings

Select RTSA Mode before making any setting in this chapter.

Because there is no calibration, these settings can be made in any order.

How to select RTSA Mode

- Press **Mode**
- Then **Real-Time SA**.

NOTE

When you initially select I/Q Analyzer, Real-Time SA, or some of the other spectrum settings (such as center frequency) a factory channel Equalization ment is applied to the signal. During channel equalization ment, the FieldFox displays a "Start Channel Equalization". Stopping channel equalization is not permitted. See also, "**Alignments**" on page 177, in **Chapter 9, "SA (Spectrum Analyzer) Mode."**

Frequency Range

The X-axis frequency range determines the frequencies that are measured for each sweep. The default Start frequency is 995 MHz. However, the Start frequency can be set as low as –100 MHz. The internal LO of the FieldFox can be seen at 0 Hz, which will mask signals that may be present.

NOTE

Although the start frequency can be set as low as -100 MHz, amplitude accuracy is specified above 9 kHz to 100 kHz (depending on your model). Below 9 kHz to 100 kHz (depending on model), frequency accuracy is maintained, but amplitude accuracy is degraded. Refer to <http://literature.cdn.keysight.com/litweb/pdf/5990-9783EN.pdf>.

The frequency range of the measurement can be changed using the following methods:

- Set Center and Span frequencies (Freq Span is settable from 280 Hz to 10 MHz)
- Set Start and Stop frequencies
- Using Marker -> Center

How to set Frequency Range

- Press **Freq/Dist**.
- Then choose from the following:
 - **Center** and **Freq Span** frequencies. This is the most common method of entering frequency range. Enter the frequency of interest. The Center frequency is at the exact center of the X-axis. The Frequency Span places half of the frequency range on either side of center.

When the Center and Frequency Span values are entered, then the X-axis annotation on the screen shows the Center and Span frequencies.

— **Start** and **Stop** frequencies. Start is the beginning of the X-axis and Stop is the end of the X-axis. When the Start and Stop frequencies are entered, then the X-axis annotation on the screen shows the Start and Stop frequencies.

— Optionally, press **More** then:

— **CF Step** then type a step size value using the numeric keypad, then select a multiplier key.

— **Freq Annotation** and one of the following:

AutoSelect (Default) – The FieldFox selects a frequency annotation setting (CenterSpan or StartStop).

CenterSpan – The center frequency and span are displayed.

StartStop – The start and stop frequencies of the frequency span are displayed.

— **Full Span** the frequency span changes to 10 MHz.

– Follow each of these, when prompted, by entering a value using the numeric keypad, the **▲▼** arrows, or the rotary knob.

– When using the **▲▼** arrows, press **Enter**. The increment setting of the arrows is based on the current span. This can be changed in RTSA Mode.

– After using the keypad, select a multiplier key. Learn more in **“Multiplier Abbreviations” on page 41**.

Scale and Units

Adjust the Y-axis scale to see the relevant portions of the data trace.

The Y-axis is divided into 10 graticules. A acquisition is shown on the screen as a solid horizontal bar that can be placed at any graticule.

RTSA always uses logarithmic scale. The Y-axis reference line represents the specified absolute acquisition (dBm). Y-axis graticules show dB below or above the reference line.

When RF Attenuation set to **Auto**, the RF Attenuation is coupled to acquisition.

How to set Scale

Press **Scale / Amptd**. Then choose from the following:

Manually set Scale, acquisition, and Reference Position.

- **Scale** Manually adjust the dB scale per division to view specific areas of the current trace. Enter a value using the numeric keypad, the **▲▼** arrows, or the rotary knob. Then press **Enter**.
- **Ref Level** Manually set the value of the reference line. Enter a negative value by pressing **Run/Hold (+/-)** either before or after typing a value. This can also change the RF Attenuation setting. See **“Attenuation Control” on page 207**.
- **Ref Pos** Manually set the position of the reference line. Values must be between 0 (top line) and 10 (bottom line). Default position is zero (top).

External Gain

When using an external amplifier or attenuator, the RTSA mode trace amplitude values can be offset to compensate for the effect of the external device. This effectively moves the reference plane of the RTSA measurement port out to just beyond the external device. For example, when using an external preamp with gain of +10 dB, enter this value for External Gain, and the data trace across the displayed frequency span will be adjusted down by 10 dB.

When RF Atten is set to Auto, you may see a change in the RF Attenuation value. This is an attempt to measure the signal at top of screen (the acquisition) without overloading the RTSA first mixer.

How to Set External Gain

- Press **Scale/Amptd**.
- Then **External Gain**
- Enter a value using the numeric keypad, the **▲▼** arrows, or the rotary knob (positive for gain; negative for loss). Values in increments less than 5 dB must be typed using the numeric keypad. Then press **Enter**

ExtGain xx dB is shown at the top of the screen.

Attenuation Control

Both the RF Attenuation and Preamp functions control the power level into the RTSA.

When too much power is present at the RF Input port, **ADC Over Range** appears on the FieldFox screen. This does not necessarily mean that damage has occurred, but that the measurement is probably compressed.

When high power levels are present at the RF Input port, internal attenuation can be switched in to keep the FieldFox receiver from compressing. At extremely high power levels, use external attenuation to protect the internal circuitry from being damaged.

CAUTION

The FieldFox can be damaged with too much power. Refer to the FieldFox Data Sheet for your model on

<http://literature.cdn.keysight.com/litweb/pdf/5990-9783EN.pdf>.

RF Damage Level: +25 dBm (N995xA & N996xA) and +27 dBm (all others)

DC Damage Level: ± 50 VDC

The displayed power level is automatically adjusted for RF Attenuation. As the attenuation value changes, the displayed power level should NOT change.

How to set Attenuation

- Press **Scale/Amptd**.
- Then **RF Atten Man Auto**
- **Auto** RF Attenuation is set by adjusting the acquisition. As the acquisition is lowered, for example from -10 dBm to -30 dBm, the FieldFox assumes that you are looking at low-level signals. The RF Attenuation value is automatically lowered in 5 dB steps to allow low-level signals to be viewed.
- **Man** RF Attenuation is set manually. Enter a value between 0 to 30 dB in 5 dB steps using the numeric keypad, the **▲▼** arrows, or the rotary knob. Then press **Enter**.

#Atten xx dB is shown at the top of the screen. (#) means manual setting.

Preamplifier Control (Opt 235)

When **very low-level** signals are analyzed, an internal preamplifier can be used to boost the signal level by approximately 15 to 20 dB (depending on model). The gain of the preamp is NOT adjustable. The displayed signal level is automatically adjusted for the increase in system gain, therefore turning the Preamp ON should NOT cause a change to the displayed signal.

How to control the Preamp

By default, the preamp is OFF.

- Press **Scale/Amptd**.
- **Preamp ON OFF** When ON, **PA** is shown to the left of the graticules on the display.

- **Auto** When Auto is selected, the preamp setting is coupled to the RF attenuation and to the acquisition. When the acquisition reaches a certain value, the preamp is turned on and **PA** is shown to the left of the graticules on the display.

Check for Compressed Measurements

Compression occurs when too much power into an amplifier causes it to no longer amplify in a linear manner. When too much power goes into the FieldFox RF Input connector, the amplifiers in the RTSA receiver compress and signal power will not be displayed accurately. This can occur even if **ADC Over Range** is not displayed because devices other than the ADC, such as the mixer, might be compressed. Increase the RF Attenuation value to prevent the RTSA receiver from being compressed.

How to Check for a Compressed Measurement

- Using a marker at the signal peak, make note of the signal power level.
- Increase the RF Attenuation level by 5 dB.
 - If the signal level does NOT change, then NO compression exists. This indicates that the signal is in the linear region of the FieldFox receiver.
 - If the signal level DOES increase, then the receiver was compressed. Set the RF Attenuation value at the setting when further increases no longer result in an increase in the displayed power level.

Spectrum Selection

CAUTION

Density Spectrum and Spectrogram data is lost when you change modes, because the FieldFox optimizes the instrument's resources during mode changes.

To select the spectrum-type for your measurement:

How to make Spectrum Settings

- Press **Measure 1**
- Then Press:
 - **Density Spectrum** The signal displayed is a real-time spectrum with a histogram bitmap. Refer to **Figure on page 210** and **Figure 10-2 on page 211**.
 - **Spectrogram** The signal is displayed is a real-time spectrum with a spectrogram bitmap. Spectrogram views are valuable in capturing signals that include both time and frequency variations. Refer to **Figure 10-3 on page 211**.

- **Real-time Spectrum** The signal is displayed as a real-time spectrum. Use real-time spectrogram to quickly display measurements. Refer to **Figure 10-4 on page 212**.

In all three spectrum measurements, there are four available traces for representation of the real-time spectrum. Density Spectrum (Histogram) FM Signal with 1 MHz FM Deviation & 400 Hz FM Rate

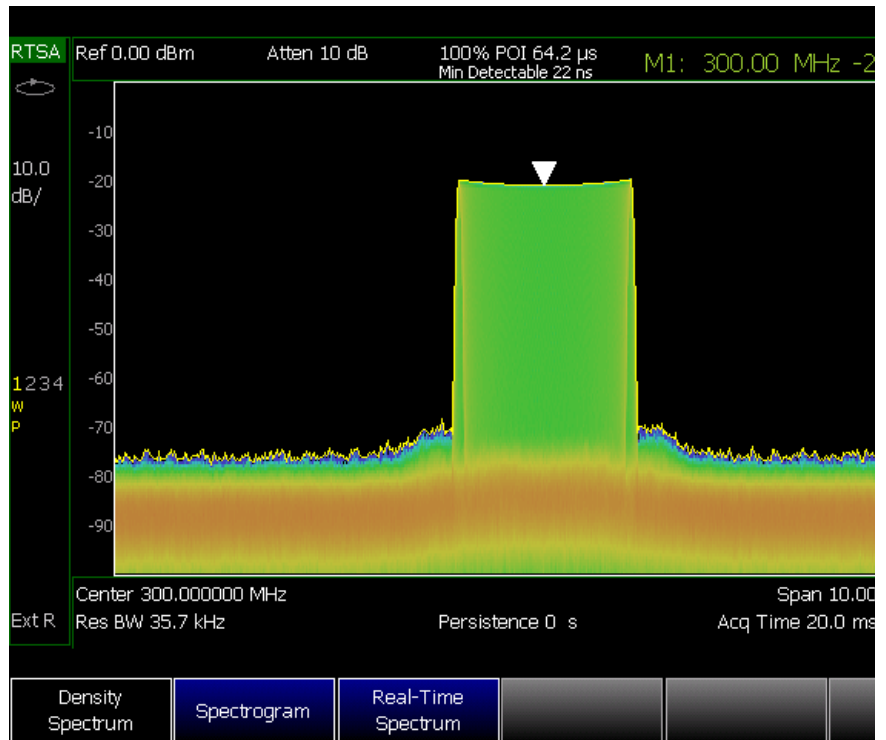

Figure 10-2

Density Spectrum (Histogram) with 2 Pulses (Blue color indicates pulse that occurs less frequently)

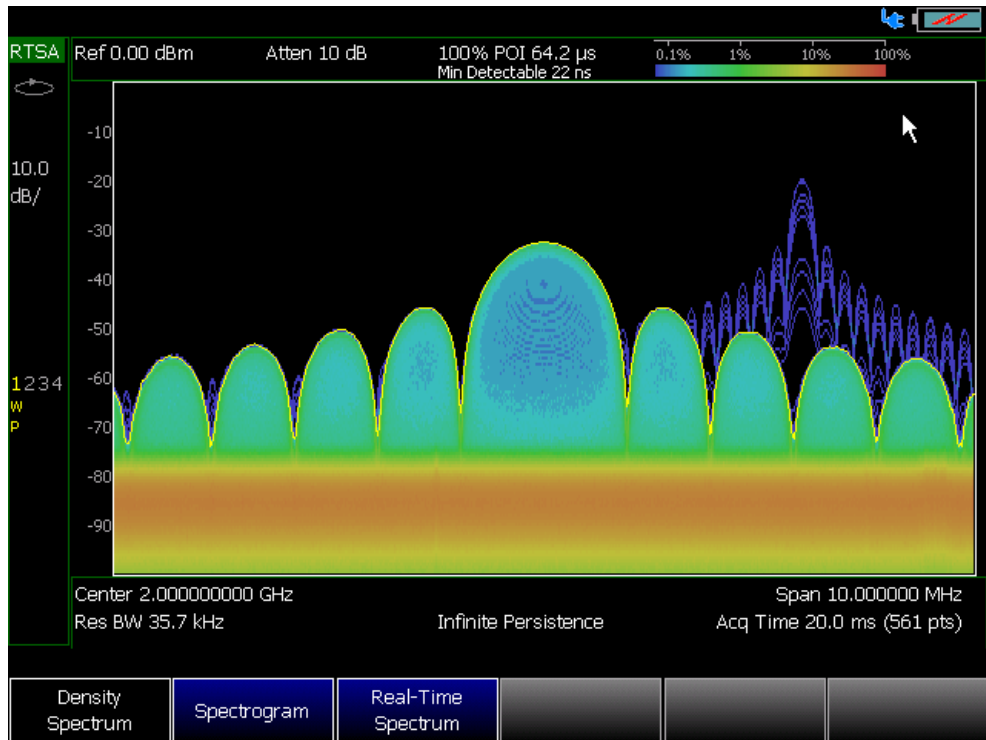
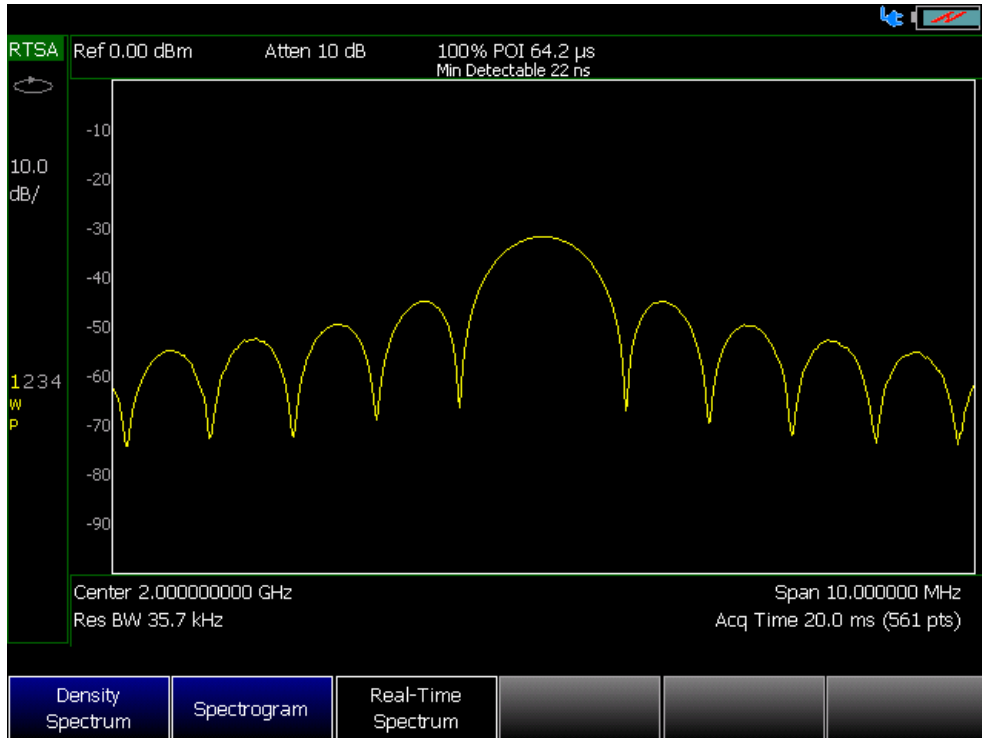

Figure 10-3

Spectrogram



Figure 10-4 Real-Time Spectrum



Resolution Bandwidth (Res BW)

CAUTION

For best results, use the AUTO setting for the Res BW values. Increasing the resolution BW could reduce pulse measurement capability by affecting the 100% POI duration and the minimum detectable signal level. The resolution BW must be as narrow as possible to maintain gapless measurements.

When Manual RBW is selected, the FieldFox attempts to set the RBW to the setting you request, but this setting is coupled to the current span settings. If the manually set RBW is not settable with the current frequency span value, the FieldFox defaults to the nearest achievable RBW setting to meet the manual RBW value.

In RTSA Mode, the Res BW provides the ability to resolve, or see closely spaced signals. The narrower (lower) the Res BW, the better the spectrum analyzer can resolve signals. In addition, as the Res BW is narrowed, less noise is measured by the spectrum analyzer ADC and the noise floor on the display lowers as a result. This allows low level signals to be seen and measured.

How to set Res BW

- Press **BW 2**.
- Then **Res BW**.

- Then choose from the following:
 - **Auto** Res BW is coupled to the frequency span. As the frequency span is narrowed, the Res BW is also narrowed providing increased ability to resolve signals.
To change this setting from **Man** to **Auto**, press **Res BW** twice.
 - **Man** Enter a Res BW value using the numeric keypad, the **▲▼** arrows, or the rotary knob. Then press a multiplier if necessary or press **Enter**

The current Res BW setting is shown at the bottom of the screen.

#Res BW x.xx XHz (#) means manual setting.

This setting could impact the accuracy of the measurement. See Specifications in Appendix B.

Triggering

NOTE

Triggering only applies to Density Spectrum and Real-Time Spectrum.

External, Video, and RF Burst triggering enable you to initiate an RTSA mode sweep using an external event such as a signal burst.

Trigger Type

- Press **Sweep 3**
- Then **Trigger Settings**
- Then **Trig Type**
- Then choose from the following:
 - **Free Run** Triggering is provided by the FieldFox internal circuitry. A new sweep begins when the previous sweep ends.
 - **External** A sweep is triggered on an external TTL signal at the Ref In/Trig In connector on the FieldFox top panel. Choose to trigger on the rising slope at about 1.7 V or on the falling slope at about 1.0 V using the Trigger Slope setting (below).

The following two selections are similar in that they both trigger a sweep from a signal at the **SA RF Input** connector. Experiment with both selections to find the best trigger type for your application.

- **Video** A sweep is initiated when the amplitude of an incoming signal crosses the settable trigger level. The comparison is done in the time domain, before conversion to frequency domain. Refer to “**Trigger Slope**”, “**Trigger Delay**”, “**Trigger Level**” on page 215, “**Auto Trigger Time**” on page 215, and to “**Trigger Hold-Off**” on page 216.

NOTE

If your trigger level is set too high for the current measurement gain setup, you will see an error message, similar to this one, displayed: "Video TrigLevel was HW Limited, it is x.xx dB above current capability". Adjust your trigger level settings until the message is no longer displayed.

- **RF Burst** A sweep is initiated when the signal at the third IF (analog) stage crosses the settable Trigger Level. This selection reacts to a wider bandwidth of the incoming signal than Video Trigger, which could be beneficial. However, RF Burst is not as sensitive to triggering on low-level signals. Refer to “**Trigger Slope**”, “**Trigger Delay**”, “**Trigger Level**” on page 215, “**Auto Trigger Time**” on page 215, and to “**Trigger Hold-Off**” on page 216.
- **Periodic** Trigger repeats at the period rate entered. Periodic trigger’s phase can be altered by the Offset value.

Then choose from the following:

- **Period** Enter a value for the trigger to repeat (100 ns to 400 ms).
- **Offset** Enter a offset value to offset the phase of the periodic trigger (-100 ms to 100 ms).
- **Reset Offset Display** Resets Offset to default 0.000000 s.

Trigger Slope

Trigger Slope determines which edge of an External, Video, or RF Burst trigger signal initiates a sweep.

- Press **Sweep 3**
- Then **Trigger Settings**
- Then **Trig Slope**
- Then choose from the following:
 - **Pos** Sweep is triggered by the rising (positive) edge of signal.
 - **Neg** Sweep is triggered by the falling (negative) edge of signal.

Trigger Delay

After a valid trigger signal is received, the sweep begins after the specified Trigger Delay time.

- Press **Sweep 3**

- Then **Trigger Settings**
- Then **Trig Delay**
- Enter a value using the numeric keypad, the **▲▼** arrows, or the rotary knob. (0 to 10 seconds)
- Then select a multiplier key or press **Enter**. Learn more in **“Multiplier Abbreviations” on page 41**.

Trigger Level

Used with Video and RF Burst triggering, a sweep is initiated when an incoming signal crosses this level. See also **“Scale and Units” on page 206**.

RF Burst Trigger Level uses an ment process which is performed in the background to set the detected signal level accuracy. **Video Trigger Level** is a comparison done on the time domain signal, before conversion to the spectral frequency domain. Processing from the time to frequency domain can cause broadband (e.g., pulsed) signal energy to display at lower power levels than the peak power levels of the time domain signal. Therefore you may need to the set trigger level higher than the displayed spectral level.

- Press **Sweep 3**
- Then **Trigger Settings**
- Then **Trig Level**
- Enter a value using the numeric keypad, the **▲▼** arrows, or the rotary knob. (–210 to 30 dBm)
- Then select a multiplier key or press **Enter**. Learn more in **“Multiplier Abbreviations” on page 41**.

Auto Trigger Time

While waiting for a valid trigger signal, **Wait** is annotated in the top left corner of the FieldFox screen.

If a valid trigger signal is not received before the specified Auto Trig Time, a sweep will occur automatically.

When Auto Trigger is OFF, the FieldFox does NOT sweep unless a valid trigger signal is received.

- Press **Sweep 3**
- Then **Trigger Settings**
- Then **Auto Trigger**
- Enter an Auto Trig Time using the numeric keypad. (1 ms to 100 seconds)
- Then select a multiplier key. See **“Multiplier Abbreviations” on page 41**.

- Enter **0** to set Auto Trigger **OFF** or press the Auto Trigger softkey a second time to turn OFF Auto Trigger.

Trigger Hold-Off

Used with External, Video, and RF Burst triggering, sets the hold-off time between triggers. (Range: 0.000000 to 10.000000 seconds)

Once a trigger occurs, future triggers are ignored until the trigger hold-off time expires. Setting the trigger hold-off to zero, essentially turns off the trigger hold-off feature. Also, you can press **Trig Hold-Off > OFF**.

Trigger Settings Annotation

Trigger settings are annotated on the FieldFox screen as shown in the following figure:

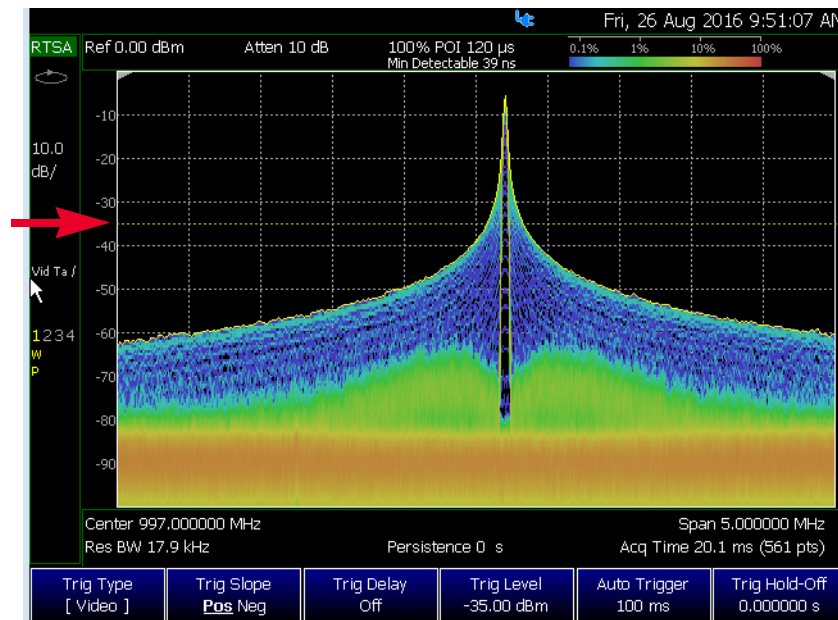

- Trig Type (**VidT**), AutoTrigger (**a**), Pos Slope (**/**)
- Horizontal arrow: Trig Level (green horizontal graticule at -35 dBm)

Single / Continuous / Restart / Time Per Div

This setting determines whether the FieldFox measures continuously or only once each time the **Single** or **Run / Hold +/-** button is pressed. Use **Hold / Single** to conserve battery power or to allow you to save or analyze a specific trace.

NOTE

- To conserve battery power, in addition to using Hold / Single, you must also, set the System > preferences > Preferences > Battery Saver to On. For more, refer to the System Settings chapter and **“Preferences” on page 469**.

How to set Single or Continuous

- Press **Sweep 3**.
- Then choose one of the following:
 - **Continuous**
 - **ON** Causes the RTSA to make continuous sweeps. This is the typical setting for making measurements. Each **Run / Hold +/-** press causes the RTSA to toggle between continuous sweep and Hold.
 - **OFF** Causes the RTSA to Hold. Each **Run / Hold +/-** or **Single** press causes the RTSA to make ONE sweep, then Hold. The Hold annotation changes to an arrow --> while the sweep occurs.
 - **Single** Automatically sets Continuous OFF and causes the RTSA to make ONE sweep, then Hold.
 - **Restart** Resets the average counter to 1. If Continuous sweep is OFF, it also causes Average Count (n) sweeps to occur if any Trace State is set to RMS Average, MinHold, or MaxHold. This softkey is also used to clear the Spectrogram display. Learn more in **“Average Count” on page 221**.

Acq Time

Use the **Acq Time** setting to adjust acquisition time interval for each trace update in Density or Real-Time Spectrum measurements.

How to set Acq Time

- Press **Sweep 3**.
- Then choose:
 - **Acq Time** Acq Time affects the quantity of information being captured during a density or real-time spectrum measurement.
 - **Auto** (default) the FieldFox chooses the optimum Acq Time based on the span setting (default is 20 ms).
 - **Manual** enables user settable acquisition time values.

Points (not user settable)

Points is the number of measurements that are displayed along the X-axis. RTSA automatically sets the points to 561 and is not user settable.

Trace Display States

NOTE

You can use the FieldFox's Remote Server mode (89600 VSA software connectivity) to parse playback files and captured data as MATLAB files (*.mat). Learn more about FieldFox and 89600 VSA software, refer to [Chapter 12, "Remote Server Mode \(Requires CPU2 and SA Hardware/SA Option 233\)"](#) and to <http://rfmw.em.keysight.com/wireless/helpfiles/89600B/WebHelp/89600.htm>.

In RTSA Mode you can display up to four of the following types of trace states. All RTSA settings are applied to all displayed traces. These traces represent the Real-Time Spectrum in each of the three measurement modes.

A color-coded legend for displayed traces is visible in the left pane of the RTSA mode screen:

W = Clear/Write; **M** = MaxHold; **m** = MinHold; **A** = Average; **V** = View

How to display the Trace States

- Press **Trace 6**.
- Then **Trace 1,2,3,4** repeatedly to select a trace number to display or change its state. Traces are displayed in the following default colors (i.e., the colors are user settable):
 - Trace 1 – **Yellow** Trace 2 – **Blue**
 - Trace 3 – **Orange** Trace 4 – **Green**
- Then **State [current setting]**
- Then choose from the following Trace States:
 - **Clr /Wr [W]** (Clear/Write) Displays the actual measured data for each sweep.
 - **MaxHold [M]** Displays the maximum response of the input signal at each data point over multiple sweeps. See also Average Count in ["Average Count" on page 221](#).
 - **MinHold [m]** Displays the minimum response of the input signal at each data point over multiple sweeps. See also Average Count in ["Average Count" on page 221](#).
 - **RMS Average [A]** Each data point is averaged over multiple sweeps as set by the Average Count setting. Learn more in ["Average Count" on page 221](#).
 - **View [V]** Displays and then holds the last complete measurement trace on the screen. This is similar to storing a trace in memory.
 - **Blank** Displays no trace.

- Press **Default All** to return all traces to their default settings: Trace 1 (Clear/Write); all other traces, including trace detectors (Blank).

Detection Method

In RTSA Mode, the X-axis is comprised of data points, also known as “buckets”. Learn more in **“Points (not user settable)” on page 217**.

Regardless of how many data points are across the X-axis, each data point must represent what has occurred over some frequency range and time interval.

From the frequency span of the measurement, the span of each data point is calculated as (frequency span / (data points-1)). The detection method allows you to choose how the measurements in each bucket are displayed.

Using the RTSA feature, each of the four available traces can have an independent detection method.

How to set Detection Method

The current Detection method for each trace is labeled on the left edge of the screen. A corresponding letter appears below the corresponding Trace number selected. For example: **N** means that **Normal** was the selected detector.

- Press **Trace 6**
- Then **Detector**
- Then choose from the following:
 - **Auto** [...] Displays the most appropriate Detection method based on other settings.
 - **Normal** [**N**] Provides a better visual display of random noise than **Positive peak** and avoids the missed-signal problem of the **Sample** Mode. Should the signal both rise and fall within the bucket interval, then the algorithm classifies the signal as noise. An odd-numbered data point displays the maximum value encountered during its bucket. An even-numbered data point displays the minimum value encountered during its bucket. If the signal is NOT classified as noise (does NOT rise and fall) then Normal behaves equivalently as Positive Peak.
 - **Positive Peak** [**P**] Displays the maximum value of all the measurements in each bucket. This setting ensures that no signal is missed. However, it is not a good representation of the random noise in each bucket.
 - **Negative Peak** [**p**] Displays the minimum value of all the measurements in each bucket.

- **Sample [S]** Displays the center measurement of all the measurements in each bucket. This setting gives a good representation of the random noise in each bucket. However, it does not ensure that all signals are represented.
- **RMS Average [A]** Displays the Root Mean Squared (RMS) average power of all the measurements in each bucket. This is the preferred method when making power measurements.

Repeat the detection setup process as needed for up to 4 traces and 4 detection methods.

Average Count, Show Density, Blue, and Red Percentage Limits

How to set:

- Press **Meas Setup 4**

Then choose one of the following:

- **Average Count** – Changes the quantity of traces averaged for certain trace states (i.e., MaxHold, MinHold, or RMS Average). Refer to **“Average Count”**.
- **Show Density** – (Density Spectrum Only) Displays a histogram image of the traces.
- **Blue Limit %** – (Density Spectrum Only) Changes the percentage of the trace that has a blue limit (0.05% to 100%, default is 0.05%). This setting is coupled to the color bar in the upper right corner of the FieldFox display.
- **Red Limit %** – (Density Spectrum Only) Changes the percentage of the trace that has a blue limit (0.05% to 100%, default is 100%). This setting is coupled to the color bar in the upper right corner of the FieldFox display.
- **Blue Limit dBm** – (Spectrogram Only) Changes the power level (dBm) of the trace that has a blue limit (–210 dBm to 30, default is –90 dBm). This setting is coupled to the color bar in the upper right corner of the FieldFox display.
- **Red Limit dBm%** – (Spectrogram Only) Changes the power level (dBm) of the trace that has a blue limit (–210 dBm to 30, default is –50 dBm). This setting is coupled to the color bar in the upper right corner of the FieldFox display.

NOTE

Blue limit and red limit percentages are coupled to the density percentage limit bar in the upper right of the FieldFox display. Or, for the blue limit and red limit power levels (dBm) are coupled to the Spectrogram power level (dBm) limit bar in the upper right of the FieldFox display.

Average Count

The Average Count setting is used mainly with the RMS Average Trace State described above. (But, also applies to the MaxHold or MinHold trace states.) In the RMS Average Trace State, the Average Count setting determines the number of sweeps to average. The higher the average count, the greater the amount of noise reduction.

For all three of these Trace States (RMS Average, MaxHold, or MinHold), when **Sweep 3 Continuous** is set to OFF, press **Restart** to reset the sweep count to 1, perform $\langle n \rangle$ sweeps, then return to **Hold**.

How to set Average Count

- Press **Meas Setup 4**
- Then **Average Count**
- Enter a value from 1 to 10,000 using the numeric keypad, the **▲▼** arrows, or the rotary knob.
- Press **Enter**

Alignments

The RTSA mode requires all three alignment types: amplitude, RF burst, and channel equalization. Refer the SA chapter's **“Alignments” on page 177** for information on all Alignments.

Display Line

A display line is a simple, horizontal line that can be placed at any amplitude level on the RTSA screen. Use a display line as mental guide for visual feedback.

Figure 10-5 Display Line with Annotations

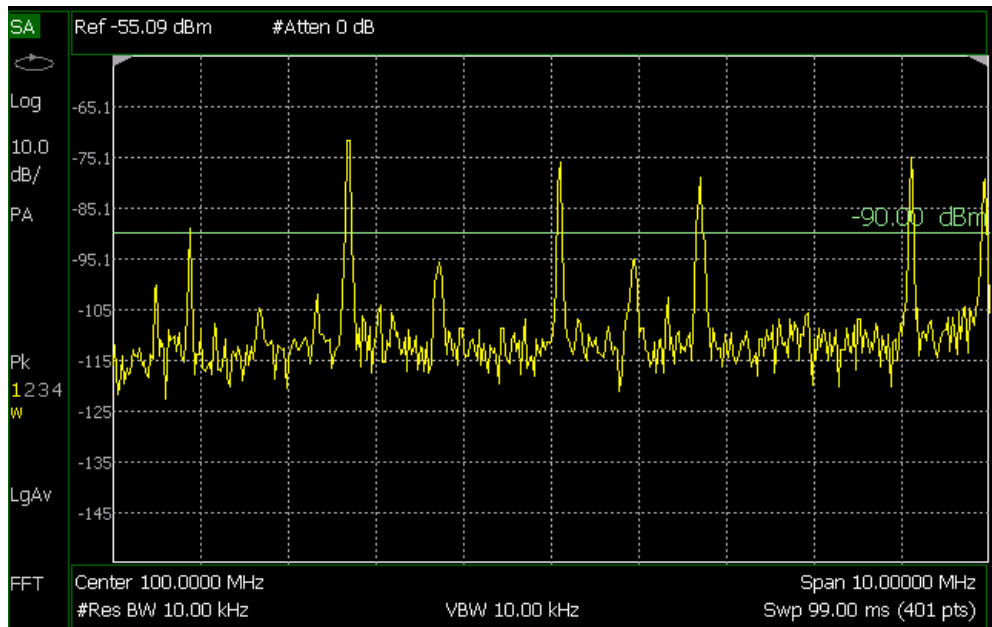

How to create and move a Display Line

- Press **Limit 8**
- Then **Display Line OFF ON**
- Then enter a Y-axis value using the **▲▼** arrows or the rotary knob, then press **Enter**. Or enter a value using the numeric keypad and press a suffix key or press **Enter**.

Spectrogram Display

Spectrogram display provides a visual history of the measured spectrum. This display type can be used to locate intermittent signals or to view signal levels and frequencies over time.

This display can NOT be used with Channel Measurements.

Spectrogram Display (RTSA Option)

Spectrogram draws the most recent trace record at the bottom of the stack of previously-drawn trace records. Drawing the live trace on the display is optional.

Figure 10-6

Spectrogram display- Overlay view

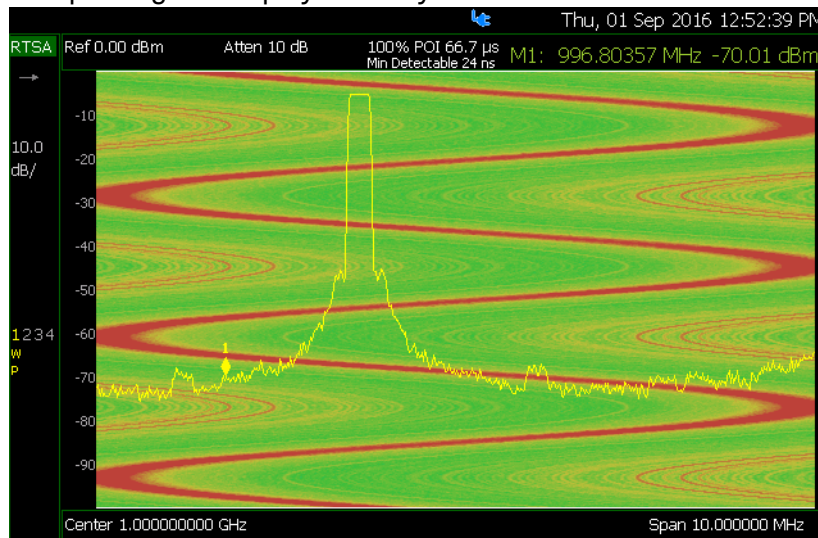

How to select Spectrogram

- Press **Meas 1**
- Then **Spectrogram**

How to modify the Spectrogram

You can change how the spectrogram is displayed relative to the data trace. This setting affects the total number of trace records that can be displayed.

For RTSA Mode:

- Press **Meas Setup 4**.
- Then **Spectrogram View**
- Then choose from the following:
 - **Overlay** Displays the data trace over the spectrogram with NO graticules. Total trace records: 340.

- **Top** Displays the data trace below the spectrogram. Total trace records: 130.
- **Bottom** Displays the data trace above the spectrogram. Total trace records: 130.

Common Settings for Spectrogram

Set Red and Blue Limits

The colors displayed on the Waterfall and Spectrogram represent the various measured power levels:

- Red = Highest power levels
- Blue = Lowest power levels

NOTE

The full Red-to-Blue color spectrum is visible only with Indoor display colors. Learn more in [“Display Colors” on page 467](#).

Adjust the Red and Blue limits to the power levels that you expect to measure. The Blue limit must always be less than the Red limit.

For RTSA Mode:

- Press **Meas Setup 4**.
- Then choose from the following:
 - **Red Limit** Using the **▲▼** arrows, rotary knob, or keypad, select the HIGHEST power level that you expect to measure. This power level, and those measured higher than this level, appear Red.
 - **Blue Limit** Using the **▲▼** arrows, rotary knob, or keypad, select the LOWEST power levels that you expect to measure. This power level, and those measured lower than this level, appear Blue.

How to Restart the Spectrogram

Press **Sweep 3** then **Restart**

Record/Playback (RTSA Option)

CAUTION

Density Spectrum information is not recorded. Only the trace data is saved. See [“How to Record a Session” on page 228](#).

NOTE

Record/Playback is only available in Density Spectrum and Real-Time Spectrum measurements. Record/Playback is not supported on Spectrogram. See [“How to Record a Session” on page 228](#).

Record Playback allows you to record RTSA trace sweeps and play them back at a later time. Use this feature to monitor spectrum activity over a period of time.

You can record traces continuously or record a specified number of traces (segments).

When GPS is enabled, the current location and elevation are saved and played back with traces.

Recordings can be saved to the FieldFox Internal memory, an SD Card, or a USB flash drive.

About Sessions

A Recording Session is a collection of recorded traces and the instrument states that generated them.

Before recording can occur, a new session must be initiated or an existing session must be opened. Sessions can later be opened for playing or continued recording. Only one session can be open at a time.

You close the session when finished recording or playing. A session is also closed when the FieldFox is Preset (or Mode Preset), an Instrument State is recalled, or when Mode is changed from RTSA.

Each session is saved as a folder containing a set of files on the specified storage device.

How long can a recording session last?

There are many variables that determine the possible length of a recording session. But one key variable is the amount of available memory.

When a session is opened or a new session is initiated, an estimate is made of the maximum number of traces that can be saved based on the available disk space and the current number of data points (resolution). Recording will stop when that number is reached. This estimate always keeps 4 MB of available disk space on the specified storage device. You can decrease the number of traces to further limit recording.

To maximize the amount of space that is available, save recorded traces to a USB Flash drive or SD card. Learn how in [“Manage Sessions” on page 232](#).

You can determine the length of time over which recording can occur by setting the Record Interval (the time between recorded traces) and other settings. Learn more in [“Recording Configuration” on page 230](#).

To view and edit the maximum number of records

Just after opening or initiating a session...

- Press **Session Data**
- Then **TraceRecordLimit <n>** (n = Max number of traces that can be recorded).
- **Clear All Records** Empties that session of recorded traces. Learn more in [“Manage Sessions” on page 232](#).

CAUTION

IMPORTANT! Pressing Clear All Records causes a loss of ALL of the session data.

FieldFox Setting Changes during Record and Playback

During Recording

When any of the following State settings are changed during recording, the State counter is incremented ([“About State and User Tags” on page 227](#)) and the settings are saved to the Session file along with the first trace to be recorded with the new setting. During playback, the trace and display annotation will reflect the change on the screen.

State settings:

Refer to [Table 10-1 on page 227](#) for a list of the applicable state settings for the RTSA options.

Table 10-1

Summary of RTSA State Settings

Option	Settings
RTSA	
	Acquisition Time
	Detector(s)
	External Gain
	Frequency Range
	Preamp On/Off
	Resolution BW
	RF Attenuation
	Trace State(s)
	Trigger Settings

Other display settings, such as Scale and acquisition, can also be changed during recording but are not saved with the session file. Think of these as settings that help YOU see the recording and playback activity. They do NOT change the data that is recorded.

During Playback

Changes to the states listed above are NOT allowed during playback.

However, all other display settings can be changed during playback to help you analyze the recorded data.

In RTSA mode, trace recordings are played back as is and the Trace State cannot be modified. No measurement post processing is allowed, and no Density or Spectrogram information can be recovered. This is because RTSA's Real-Time Spectrum and Density displays are not derived from the trace data, but instead require independent high speed hardware acquisition.

Record/Playback Exceptions

Markers can be activated and moved to help analyze recorded data. However, marker position control is only available when playback is Paused.

About State and User Tags

When any of the State settings (listed above) are changed during a recording, a 'state tag' is inserted at the first trace number to be recorded with the new setting.

In addition, you can insert a 'User Tag' at any time during a recording session to indicate an external event, such as when an antenna is moved. During playback, you can move quickly to any of these tags, or scroll through these tags.

A symbol is used on the screen annotation to distinguish a User Tag from a State Tag when scrolling through tags during playback.

Screen Annotation

During a record or playback session, the following is displayed in the top-left area of the screen:

– **AutoSession02: 92/95 (state 4/5) *_**
Sep.22.2009 09:15:15 AM

where:

- **AutoSession** is an auto-generated name for sessions. **02** is the auto-generated number, incremented with each new session. The name can be changed using Manage Sessions. Learn more in [“Manage Sessions” on page 232](#).
- **92/95** is the current and total trace number: currently trace is 92 of 95 total traces.
- **state 4/5** is the current and total state tag or user tag number: 4 of 5 total tags.
- ***** (Asterisk) indicates that a state has changed. **#** (Pound) indicates that a User Tag has been inserted.
- **Sep.22..** is the date and time of recording.

When GPS is enabled, the current location and elevation are annotated at the bottom of the playback display. Learn more in [“GPS” on page 475](#).

NOTE

If Recording or Playback is not occurring when you think it should, check the following:

- Is the sweep in HOLD? (upper-left annotation), or check the Sweep menu for Continuous set to OFF.
- Is Recording or Playback Paused? (mid-left annotation)
- Is the Record or Playback Interval set too long? (Configuration settings.)

How to Record a Session

- Press **Trace 6**
- Then **Record Playback**
- Then either:

- **New Session** OR
- **Recall Session** then **Open** and select a session.
- Then **Recorder Player**
- Then **Record**

REC is displayed in the left of screen graticules.

During recording, choose from the following:

- **Pause Resume** Temporarily halts recording until pressed again. The incoming trace continues to sweep. Press again to continue recording.
- **Stop** Immediately stops recording. Then choose from the following:
 - Press **Play** to start replaying the recording from the beginning.
 - Press **Record** to continue recording.
- **User Tag** Press to insert a User Tag at the current recorded trace. This allows you to quickly move to this location during playback. Learn more in About State and User Tags in **“About State and User Tags” on page 227**.

How to Playback a Session

- Press **Trace 6**
- If the session is already open, skip the following step. Otherwise:
- Then **Record Playback Setup**
 - Press **Recall Session** Then select a session to playback and press **Open**.

NOTE

If these are large recordings on a device, it could take several seconds for the FieldFox to display the list.

-
- Then **Recorder Player**
 - Then **Play**

PLAY is displayed in the left of screen graticules during playback. When the end of the recording is reached, playback begins again at trace 1 and continues to loop indefinitely.

During playback, choose from the following:

- **Pause Resume** Temporarily halts playback. Then choose from the following:
 - **Pause Resume** Press to continue playing.

- **Playback State/Tag** Allows you to continue playback from a state tag, or scroll through the state tags. Enter a value between 1 and the total number of state tags using the numeric keypad, **▲▼** arrows, or the rotary knob. Active when playback is paused. Learn more in **About State and User Tags** in **“About State and User Tags” on page 227**.
- **Playback Trace** Activated automatically when Paused. Allows you to continue playback from a specific trace, or scroll through traces manually. Enter a value between 1 and the total number of traces using the numeric keypad, **▲▼** arrows, or the rotary knob.
- **Stop** Immediately stops playback. Then choose from the following:
 - **Play** Start playback from trace 1.
 - **Record** Resume recording from the last recorded trace.
 - **Record Playback Setup** Return to the setup menu to change Configuration settings or Close the session.

Recording Configuration

To change Recording Configuration settings:

- Press **Trace 6**
- Then **Record Playback**
- Then **New Session** or **Recall** an existing session.
- Then **Recording Configuration**

Then choose from the following:

- **Record Time** Sets the amount of time to record traces. Default is MAX, which is to record indefinitely. Enter a value between 1s and 1 Ms (million) seconds using the numeric keypad, **▲▼** arrows, or the rotary knob. When set, a timer appears during recording in the lower-left corner which counts DOWN from the specified time.
- **Record Source** Determines which trace is recorded. Sets where, in the FieldFox data flow, data is recorded. Learn more in **“Record Source” on page 231**. Choose from the following:
 - **First Active Trace** (Default) This setting automatically selects the first active trace (1,2, 3 or 4) (i.e., any state other than View or Blank).
 - **Trace 1,2,3,4** Records data from the corresponding trace in its current state.

- **Record Interval** Sets the amount of time to wait between individual trace recordings. Default is MIN, which is to wait 0 seconds (record traces as fast as possible). Enter a value in seconds between 0 (no delay) and 10,000 seconds - about 3 hrs) using the numeric keypad, **▲▼** arrows, or the rotary knob.
- **Segment Count** Sets the number of traces to record, after which the recording will automatically pause. Press Pause/Resume or Record to capture another N traces, or Stop to end recording. Default is OFF, which is NO limit to the number of traces to be recorded.

When set, a counter appears in the lower-left corner which counts UP to the specified number of recordings.

Record Source

RTSA can only record one of the four possible traces. The simplest way to use Record Playback is to use First Active Trace (default trace).

NOTE

For this discussion, it is important to understand Trace States. Learn more in **“Trace Display States (SA Mode)”** on page 175.

Figure 10-7

FieldFox RTSA Mode: Data Flow and Record Playback Data Points

RTSA Record/Playback Data Flow

Trace 1, 2, 3, 4

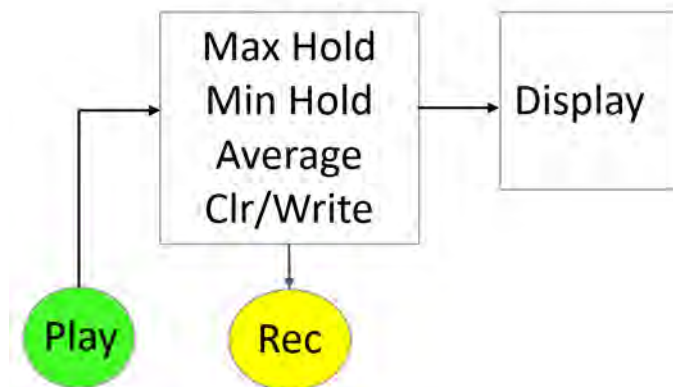

RTSA Data Recording:

CAUTION

Density Spectrum information is not recorded. Only the trace data is saved.

- Data is recorded at the trace state processing block.

- Data can be recorded from Traces 1,2,3, or 4 which includes the trace state (Max Hold, Min Hold, and so forth).
- Data is ALWAYS played back into the same trace number that was recorded. If four traces were active during the recording, but only one trace was recorded, then during Playback only that one recorded trace is visible.

Playback Configuration

By default, trace sweeps are played back as fast as the trace can be drawn on the screen. The following setting allows you to slow playback. In addition, you can manually scroll through individual traces using Playback Trace, or scroll through State and User Tags using Playback State/Tag. Learn more in **How to Playback a Session** in “[How to Playback a Session](#)” on page 229.

To slow playback of a session:

- Record a new session or Open an existing session.
- Press **Playback Configuration**
- Then **Playback Interval**
- Enter a value in seconds between 0 (no delay) and 100 using the numeric keypad, **▲▼** arrows, or the rotary knob. After using the keypad, select a multiplier key. Learn about multiplier abbreviations.
- Press **Enter**

Manage Sessions

- Press **Trace 6**
- Then **Record Playback**
- Then **Record Playback Setup** The following selections are available ONLY when a session is NOT open.
- Then **Storage Device** to select the media which stores the sessions to be managed. This is a different setting from the Save/Recall Storage Device setting.
- Then choose from the following:
 - **Internal** FieldFox memory (default)
 - **SD Card** An external SD Card (must be inserted)
 - **USB** An external USB flash drive (must be inserted)
- Then **Manage Sessions**

NOTE

If these are large recordings on a device, it could take several seconds for the FieldFox to display the list.

- Then choose from the following:
- **Rename** Using the FieldFox labeler, change the name of the session. AutoSession (n) is the default name where (n) is the next-available number. Learn more in [“How to use the FieldFox labeler ” on page 500.](#)
- **Sort** Arrange the listing of sessions **by Name**, **by Date**, or **by Size**. Sort can also be used during a Recall Session, before choosing a session to open.
- **Delete** After a confirmation prompt, removes the contents of the selected session from the list.
- **Copy** Copies the selected session to a different storage device, or the same storage device with ‘Copy(n)_’ appended to the beginning of the name so that duplication is prevented.
- **Copy All** Copies ALL of the listed sessions to a different storage device, or the same storage device with ‘Copy(n)_’ appended to the beginning of the names so that duplication is prevented.
- **Delete All** Deletes ALL of the listed sessions.

Record Playback Example (RTSA Mode Only)

The following “Interval Recording” example shows how you can record spectral activity over a longer period of time with less trace storage.

- Press **Trace 6**
- Then **Record Playback**
- Then **New Session**
- Then **Recording Configuration**
- Then **Record Source** to Trace1
- Then **Back**
- Then **Recorder Player**
- Then **Record** let the recorder run for several seconds.
- Then **Stop** to end the recording.

This session can be played back: For example:

- Press **Trace 6**
- Then **Record Playback**
- Then **Play**

RTSA (Real-Time Spectrum Analyzer) Mode—Option 350 (CPU2 Only)
Record/Playback (RTSA Option)

11 IQ Analyzer (IQA) – Option 351 (CPU2 Only)

IQA mode measures signals at the **SA RF IN** connector.

IQA mode requires the FieldFox to have SA mode and CPU2 installed.

Figure 11-1 IQ Analyzer (IQA) Display - LTE-TDD signal captured using the FieldFox's I/Q analyzer

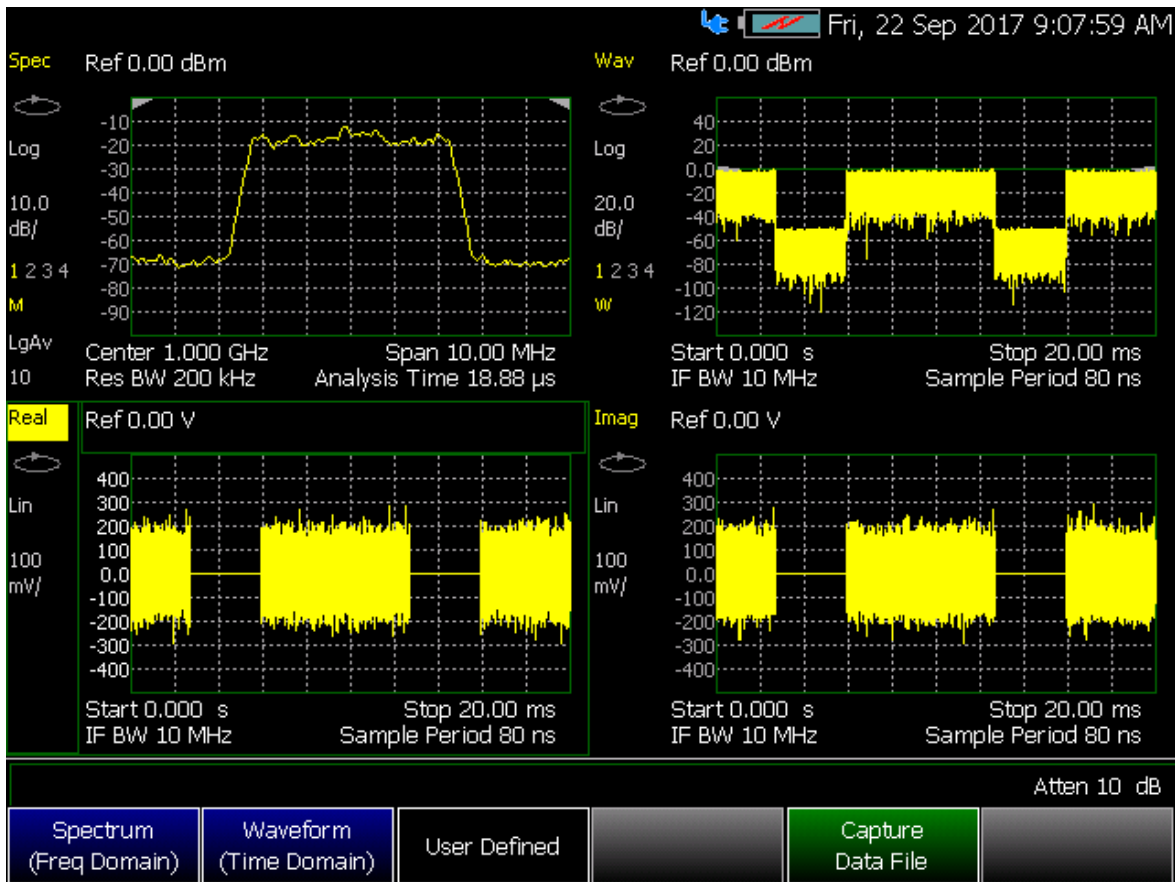

In this Chapter

“About I/Q Analyzer (IQA) Measurements” on page 238

“I/Q Analyzer (IQA) Mode Settings” on page 239

- **“How to Make Measurements Using the I/Q Analyzer Mode” on page 239**
- **“How to Capture I/Q Data to a File” on page 240**
- **“How to modify the I/Q data measurement parameters” on page 243**

“Using Markers (IQA)” on page 254

- **“Noise Marker” on page 254**
- **“Band/Interval Power Marker” on page 255**
- **“Band Span Marker (Spectrum Only)” on page 256**
- **“Interval Span Marker (Waveform Only)” on page 256**
- **“Coupled Markers (Waveform Only)” on page 256**
- **“Continuous Peak Search Marker” on page 258**

“Alignments” on page 259

“Trace Display States (IQA Mode)” on page 259

- **“How to display the Trace States” on page 259**

“Other Features Available” on page 261

- External Gain (SA chapter) – **“External Gain” on page 152**
- Display lines (SA chapter) – **“Display Line” on page 186**
- Limit Lines (Data Analysis chapter) – **“All about Limit Lines” on page 453**

See Also

[“Why and When to Calibrate” on page 120](#)

[“All about Markers” on page 438](#)

[“All about Limit Lines” on page 453](#)

[“All about Trace Math” on page 458](#)

[Chapter 24, “Data Analysis Features.”](#)

[Chapter 27, “File Management.”](#)

About I/Q Analyzer (IQA) Measurements

The I/Q Analyzer Mode makes general purpose frequency domain and time domain measurements. The mode enables two types of I/Q measurements:

- frequency domain and
- time domain measurements

In order to ensure consistent results between frequency domain and time domain, spectrum measurement and waveform measurement are based on the same I/Q acquisition. The following acquisition parameters are automatically calculated to satisfy these requirements:

1. RBW and IF BW specified in Spectrum measurement BW (**BW 2**) menu.
2. Start time and Stop time specified in Waveform measurement Sweep (**Sweep 3**) menu and IF BW specified in Waveform measurement BW (**BW 2**) menu.
3. I/Q signal capture related parameters specified in the Measurement Setup (**Meas Setup 4**) menu.

Some measurement parameters are auto-coupled and are not user-settable.

I/Q Analyzer (IQA) Mode Settings

NOTE

When you initially select I/Q Analyzer, Real-Time SA, or some of the other spectrum settings (such as center frequency) a factory channel Equalization ment is applied to the signal. During channel equalization ment, the FieldFox displays a "Start Channel Equalization". Stopping channel equalization is not permitted. See also, "Alignments" on page 177, in Chapter 9, "SA (Spectrum Analyzer) Mode."

Select IQA Mode before making any settings in this chapter.

How to select IQA Mode

- Press **Mode**.
- Then **More** (may not be available—number of installed options dependent)
- Then **I/Q Analyzer**.

How to Make Measurements Using the I/Q Analyzer Mode

The Measure menu is used to set common parameters, predefined views selection, and measurement switching.

Spectrum has only one predefined view and Waveform measurement has two predefined views. There is a User Defined measurement, which can be used to display up to four different views (windows) simultaneously on the display screen. You can select which type of data to display in each of the views from the **Trace** menu.

See also, "How to Capture I/Q Data to a File" on page 240.

1. Press **Preset** then **Mode Preset (Factory)**
2. Press **Measure 1** then choose from the following:
 - **Spectrum (Freq Domain)** (Default) – Selects frequency spectrum as the current displayed measurement.
 - **Waveform** then choose one of the following:
 - **RF Envelope** Selects log RF envelope in time domain (default).
 - **I/Q Waveform** Selects linear Real and imaginary I/Q waveform values.
 - **User Defined** Selects a default user defined 4-quadrant display showing the following data:
 - Log magnitude of the spectrum of the I/Q data versus frequency
 - Log magnitude of the I/Q data (RF Envelope) versus time

- The real component of the I/Q data versus time
- The imaginary component of the I/Q data versus time

The user defined measurement can be modified to change the number of displays from 4 to 3, 2, or 1.

- **Capture Data File** Opens a menu to enable saving I/Q data to a file. When you press the **Start** capture softkey the data is saved to a file and the default file `IQDataFile.csv` is stored in the internal memory. Refer to **“How to Capture I/Q Data to a File” on page 240.**

How to Capture I/Q Data to a File

CAUTION

I/Q data cannot be recalled or displayed in the FieldFox instrument. The data file is intended for use in a PC.

There are two I/Q data file count capture modes, **Single** and **Multiple**. To capture your IQA data measurements:

- Press **Measure 1** > **Capture Data File** then choose one of the following:
 - **File Settings** Opens a menu to set the file choices:
 - **File Count** File count can be set to **Single** or **Multiple**. When using **Multiple** as the file count, the user can enter the number of files to save, and the FieldFox is auto-coupled to Continuous acquisition mode and to **Multiple** capture and all data is saved to either an external SD card or USB storage device. Each acquisition is saved, before the next data acquisition occurs. (default: 1, minimum: 1, maximum: 1,000,000,000)
 - Single capture example (default): `IQDataFile.csv`
 - Multiple capture (default):
Example is: `IQDataFile_20171031 14.33.26.1050.csv`.
(format is: `IQDataFile_yyyymmdd hh.mm.ss.ffff.csv`).
 - Refer to the **Start** softkey on **page 241** and to the **“Example:” on page 243.**
 - **File Type** Selects the format of the output data file (CSV, TXT, SDF, or MAT). (Default: CSV)
 - **Device** Selects the storage location for your data files (Internal, SD Card, or USB). Internal is not available, if the File Count is set to **Multiple** (default: Internal).

If you do not have an external device connected and attempt to save your data, a warning message is displayed: "Warning: Only an external storage device can be used in multiple file mode."

Then select:

- **Internal** (default) Selects the internal memory of the FieldFox as the storage location for all data files. Internal is only available when File Count is set to Single.
- **SD Card** Selects the external SD card slot as the storage location for all data files.
- **USB** Selects an external USB storage device as the storage location for all data files.
- **Filename** Opens a file manager Labeler menu that enables you to customize your data filenames. Refer to **"File Management" on page 497** (default: IQDataFile).
- **Back** Returns to the previous softkey menu.
- **Capture Settings** then choose one of the following:
 - **Capture Time** Sets the length of the I/Q trace capture time (default: 100 μ s, range: 80 ns to dynamic (i.e., Maximum capture time is 335.544 ms, which is associated with a sample rate of 12.5 MHz)).
 - **Sample Rate** Sets the I/Q data sample rate value (default: 12.5 MHz, maximum: 12.5 MHz, couplings: 1.25 * IF Bandwidth).
 - **Sample Period** Sets the 1/Sample Rate value (default: 80 ns, maximum: 80 ms, couplings: Sample Rate).
 - **Capture Samples** Sets the capture length using a sample number (default: 1251, minimum: 1, maximum: 4194304, couplings: Capture Time).
 - **Back** Returns to the previous softkey menu.
- **Start** Starts the I/Q data capture and stores the data into a default file and location (internal). Filenames and storage location can be customized. See also, the **"Example:" on page 243** and to **Chapter 27, "File Management."**
 - Refer to the **File Count** softkey on **page 240**.

CAUTION

Each time you press the **Start** softkey the I/Q data writes to the current filename (i.e., Single capture default is IQDataFile.csv or for Multiple format is IQDataFile_YYYYMMDD hh.mm.ss.ffff.csv). To avoid overwriting your Single capture data or to add a unique filename for Single or Multiple capture data, use the **Measure 1 > Capture Data Settings > File Settings > Filename** softkey to modify your filename Refer to the **File Count** softkey on [page 240](#).

- **Stop** immediately stops the I/Q data file capture and stops writing data to the current I/Q data file (no data is saved). If the I/Q data was being saved when the Stop softkey is pressed, the file is deleted. Refer to **“Example:” on page 243**.

Example:

Single:

—If the **Capture Time** is set to 100 μ s, and you press the **Start** softkey, in **Single** mode the FieldFox saves 100 μ s of the current I/Q data.

Multiple:-

—If the File Count is set to 200, and you press the **Start** softkey, the FieldFox saves your 200 I/Q data files and stops. The I/Q data files are saved into 200 files similar to:

IQDataFile_yyyymmdd hh.mm.ss.ffff.csv.

—If you press **Stop**, before the 200 I/Q data files have been saved, the FieldFox stops (interrupts) the multiple I/Q data file saving at the number of the current file. So, if you press Stop on file number 175, the saving process stops. If file number 175 has not been saved, it is deleted. But, I/Q data files 1 through 174 that have been saved prior to pressing **Stop**, are still saved for reference.

See also, **Chapter 27, “File Management.”**

How to modify the I/Q data measurement parameters

The following sections assume you have already selected your I/Q data measurement type (i.e., Spectrum, Waveform (RF Envelope or I/Q Waveform), or User Defined).

This section contains the following:

“Adjusting the Bandwidth Settings” on page 243

“Changing between the Continuous and Single captures and adjusting the Trigger settings” on page 246

“Adjusting the Measurement Setup Settings” on page 248

“Adjusting the Trace Settings” on page 249

“Adjusting the Frequency Settings” on page 250

“Adjusting the Scale and Amplitude Settings” on page 251

“Preamplifier Control (Opt 235)” on page 253

Adjusting the Bandwidth Settings

- Press **BW 2**.
- Then choose from the following:

- **Res BW** (Spectrum only) – Sets the resolution bandwidth of the FFT analysis. Changing this value changes the FFT window size, analysis length, and the sweep time (data acquisition capture length). This softkey is only available when IQA is set to Spectrum (Freq Domain). When the resolution bandwidth value is set to Auto (default) the FieldFox automatically sets the optimum resolution bandwidth value. (Default: 200 kHz, Minimum: 0.1 Hz, maximum: 3 MHz).

NOTE

There is a significant difference between resolution BW in FFT measurements and the resolution BW of a traditional "sweeping" spectrum analyzer (SA) measurement. The resolution BW in FFT measurements does not directly control the IF BW like a traditional SA swept measurement. Resolution bandwidth is directly related to the analysis length (window) and or data acquisition capture length (sweep time).

- **Analysis Length** Sets the FFT analysis length that is the length of the complex I/Q data points (I/Q-pairs) vector that is used for spectrum analysis, expressed in the number of samples. (Couplings: In Auto, this setting is directly coupled to the Res BW and to Span. Minimum: 8, Maximum: 524,288. Where each FFT length "point" is equal to 1 I and 1 Q point. So, 237 is equal to 237 I and 237 Q points).
- **FFT Window** Sets the FFT filtering window (spectrum analysis window) shape for the I/Q data. Default: Flat Top

Then select one of the following:

FFT Window	Description
Uniform	No windowing
Triangular	Barlett windowing
Hanning	This is a Hann window, sometimes called Hanning or "raised cosine".
Hamming	This window has lower side-lobe peaks than the Hann window, but has worse main-lobe flatness and poor side-lobe roll-off.
Blackman	This window is similar to the three-term Blackman-Harris window, but it has simpler fixed-form coefficients and better side-lobe roll-off.
Blackman Harris 3	This is the three-term Blackman-Harris window. This has the minimum side-lobe level for a three-term cosine window.
Blackman Harris	This is the four-term Blackman-Harris window. This has the minimum side-lobe level for a four-term cosine window with 60 dB/decade roll-off.
Gaussian Top	This is a five-term cosine window that resembles a Gaussian window.

IQ Analyzer (IQA) – Option 351 (CPU2 Only)
 I/Q Analyzer (IQA) Mode Settings

FFT Window	Description
Flat 4	This is a four-term flat-top window.
Flat Top (default)	This is the five-term flat-top window.
Flat 6	This is a six-term flat-top window.
Flat 7	This is a seven-term flat-top window.
P501	This is an alternative six-term flat-top window.
P601	This is an alternative seven-term flat-top window.
K-B (70 dB)	This is a Kaiser-Bessel window whose maximum side-lobe level is -70 dB.
K-B (80 dB)	This is a Kaiser-Bessel window whose maximum side-lobe level is -80 dB.
K-B (90 dB)	This is a Kaiser-Bessel window whose maximum side-lobe level is -90 dB.
K-B (100 dB)	This is a Kaiser-Bessel window whose maximum side-lobe level is -100 dB.
K-B (110 dB)	This is a Kaiser-Bessel window whose maximum side-lobe level is -110 dB.
K-B (120 dB)	This is a Kaiser-Bessel window whose maximum side-lobe level is -120 dB.
Gaussian (60 dB)	This is a Gaussian window whose maximum side-lobe level is -60 dB.
Gaussian (70 dB)	This is a Gaussian window whose maximum side-lobe level is -70 dB.
Gaussian (80 dB)	This is a Gaussian window whose maximum side-lobe level is -80 dB.
Sinc	This window is the central lobe of the $\sin(x)/x$ (often called $\text{sinc}(x)$) function.
Tukey25	This is a tukey (cosine-tapered) window with alpha equal to 0.25.

- **IF BW** Sets the Digital IF bandwidth of the instrument. The relationship between the IF bandwidth and sample rate can be described by the following equation:

$$\text{sample rate} = 1.25 * \text{IF BW.}$$

(Default: 10 MHz, minimum: 10 Hz, maximum: 10 MHz)

Changing between the Continuous and Single captures and adjusting the Trigger settings

- Press **Sweep 3**.
- Then choose from the following:
 - **Single** When pressed, Single automatically sets Continuous to OFF and causes the application to make one acquisition.
 - **Continuous** Toggles Continuous between ON and OFF. When Continuous is ON, each Run/Hold press causes the application to toggle between continuous acquisitions and Hold. When Continuous is OFF, each Run/Hold or Single press causes the application to make one acquisition.
 - **Restart** When pressed, Restart causes the FieldFox to restart trace averaging at count of 1. When in Single sweep mode, the IQA will perform a complete set of averages before returning to the hold state.
 - **Start Time (Waveform only)** Sets the start time of the waveform measurement (default: 0s, minimum: 0s, maximum: dynamic). In Waveform mode Setting the Start and stop time enables you to display a subset of the data on the display in order to speed up the refresh rate when the acquisition time is long. Changing the Start Time changes which data point is displayed on the left side of the screen.

Couplings: When the change of Stop Time makes time domain display length exceed the limitation, the Start Time will change to satisfy time domain display length limitation:

- The maximum value is determined by current Sample Rate and the maximum capture samples.
- Start Time is adjusted to the nearest sample point based on the Sample Period.
- The maximum time domain display length is 524,288 points.

$$\text{Time Domain Display Length [pts]} = \{[\text{Sample Rate[pts/s]} \times (\text{Stop Time[s]} - \text{Start Time[s]})] + 1\}$$

Where:

pts = points

s = seconds

- **Stop Time (Waveform only)** Sets the stop time for the waveform display (default: 100 μ s, minimum: 0s, maximum: dynamic). In Waveform mode Setting the Start and stop time enables you to display a subset of the data on the display in order to speed up the

refresh rate when the acquisition time is long. Changing the Stop Time changes which data point is displayed on the right side of the screen.

Couplings: When the change of Stop Time makes time domain display length exceed the limitation, the Start Time will change to satisfy time domain display length limitation:

- The maximum value is determined by current Sample Rate and the maximum capture samples.
- Stop Time is adjusted to the nearest sample point based on the Sample Period.
- The maximum time domain display length is 524,288 points.

$$\text{Time Domain Display Length [pts]} = \{[\text{Sample Rate[pts/s]} \times (\text{Stop Time[s]} - \text{Start Time[s]})] + 1\}$$

Where:

pts = points

s = seconds

- **Trigger Settings** Opens the Trigger Settings softkey menu.

Then:

- **Trig Type** Then select one of the following:

Softkey	Description
Free Run	(Default.) – Triggering is provided by the FieldFox internal circuitry. A new acquisition begins when the previous acquisition ends.
External	An acquisition is triggered on an external TTL signal at the Ref In/Trig In connector on the FieldFox top panel. Choose to trigger on the rising slope at about 1.7 V or on the falling slope at about 1.0 V using the Trigger Slope setting (below).
Video	An acquisition is initiated when the displayed amplitude of an incoming signal crosses the settable Trigger Level. This selection can detect low-amplitude signals, but also has been filtered considerably and may not be a true representation of the incoming signal.
RF Burst	An acquisition is initiated when the signal at the third IF (analog) stage crosses the settable Trigger Level. This selection offers a wider bandwidth and may be a better representation of the incoming signal than Video trigger. However, RF Burst is not as sensitive to triggering on low-level signals.

—Then depending on the trigger type selected, choose from the following:

Trig Level – Sets the trigger level. This softkey is only active for Video or RF Burst (default: –25 dBm, minimum: –210 dBm, maximum: 30 dBm).

Trig Slope – Sets the negative/positive trigger slope. This softkey is only active for External, Video, or RF Burst (default: Pos).

Trig Delay – Sets the trigger delay. This softkey is only active for External, Video, or RF Burst (default: 0s, minimum: –150 ms, maximum: 500 ms).

Glitch Mask – Enables the glitch mask to reduce incorrect triggering due to fast changes/glitches in the signal level that can be mistaken to be the edge of the RF burst. This softkey is only active for RF Burst (default: 0 ms, minimum: 0s, maximum: 5 ms).

Auto Trigger – While waiting for a valid trigger signal, **Wait** is annotated in the top left corner of the FieldFox screen.

If a valid trigger signal is not received before the specified Auto Trig Time, an acquisition will occur automatically.

Enter **0** to set Auto Trigger **OFF**. When Auto Trigger is OFF, the FieldFox does NOT perform an acquisition unless a valid trigger signal is received.

(Default: 100 ms, minimum: 1 ms, maximum: 100s)

Adjusting the Measurement Setup Settings

– Press **Meas Setup 4**.

– Then choose from the following:

– **Average Type** Opens a menu of averaging softkeys.

Then select one of the following:

—**Power** (Linear) Averaging – Best for measuring true power levels. Used in Noise Marker Average. Mathematically, trace noise is 2.5 dB higher than when using Log Average. **PAvg** annotation is displayed.

—**Log** Averaging (default) – Best for displaying Trace Averaging. Also known as video averaging. **LgAvg** annotation is displayed.

—**Voltage** (Magnitude) Averaging – Converts the amplitudes to a magnitude unit before averaging (e.g., Volts, Amps, microVolts, milliVolts, etc.) **VAvg** annotation is displayed.

- **Average Count** The Average Count setting is used with the Average Trace State. In this Trace State, the Average Count setting determines the number of acquisitions to average. The higher the average count, the greater the amount of noise reduction (default: 10, minimum: 1, maximum: 10000).
- **Sample Rate** Sets the I/Q data sample rate value (default: 12.5 MHz, maximum: 12.5 MHz, couplings: 1.25 * IF Bandwidth).
- **Sample Period** Sets the 1/Sample Rate value (default: 80 ns, minimum: 80 ns, maximum: 80 ms, couplings: 1/Sample Rate).

Adjusting the Trace Settings

The Trace menu is used to modify the existing predefined view, or create a customized view. Window and Win State softkeys are used to modify layout of view, the Data softkey is used to specify the displayed data results for the current window. Please note only in User Defined measurement are all of the data results from Spectrum measurement and Waveform measurement available. Otherwise, only the data results from the current measurement (Spectrum or Waveform) are available. See also **“Trace Display States (IQA Mode)” on page 259.**

The Trace and Trace State keys are used to choose how many traces of the data result are displayed, and the trace data type (Clr/Wr, MaxHold, MinHold, Average, View, or Blank) that are displayed for each measurement.

- Press **Trace 6**.
- Then choose from the following:
 - **Window 1 2 3 4** Changes the selected window (default: 1).
Then select one of the following:
 - **Win State ON OFF** Enables or disables the current Window (1, 2, 3, or 4) selected by the Window 1 2 3 4 softkey (default: Window 1 is set to ON).
 - **Data** Sets the data type displayed.

Then select one of the following:

For **Spectrum Measurement:**

Mag Spectrum

Time Summary – Time Summary result includes the capture time, spectrum analysis time and waveform start/stop time.

For **Waveform Measurement:**

I vs. Time – Imaginary vs. Time

Q vs. Time – Quadrature vs. Time

Q vs. I – Quadrature vs. Imaginary

RF Envelope

Phase vs. Time

Unwrapped Phase vs. Time

Time Summary – Time Summary result includes the capture time, spectrum analysis time and waveform start/stop time.

- **Trace 1 2 3 4** Pressing the Trace key enables you to select a different trace number. This softkey is active when Data is set to Spectrum or RF Envelope.

NOTE

Spectrum and RF Envelope have six markers that can be applied to any of the 4 traces.

Waveform's six markers can be applied to RF Envelope, Real, Imaginary, Phase, Unwrapped Phase, and Q vs. I.

- RF Envelope has four traces.
- Real, Imaginary, Phase, Unwrapped Phase, and Q vs. I have 1 trace each.

-
- **Trace State** Sets a different trace state to each of four traces. This softkey is active when the data is set to Spectrum or RF Envelope (Log). Pressing the Trace State softkey enables you to change the State of the selected Trace number of the Trace Data (default: Clr/Wr – assigned to trace 1. Traces 2, 3, and 4 are set to Blank).

Adjusting the Frequency Settings

- Press **Freq/Dist**.
- Then select from the following:
 - **Center** Sets the center frequency of the measurement trace (default: 1 GHz, minimum: 0 Hz, maximum: FieldFox model dependent).
 - **Freq Span** (Spectrum Only) Sets the frequency span of the measurement trace. The analyzer's digital IF bandwidth is always equal to this value.

Changing the span causes the IF bandwidth and the sample rate to change automatically:

Span = IF bandwidth, sample rate = 1.25 * IF bandwidth

Res BW = Span /50, if resolution bandwidth = Auto.

Default: 10 MHz, minimum: 10 Hz, maximum: 10 MHz

Adjusting the Scale and Amplitude Settings

Enables you to change attenuation settings. When RF Attenuation Auto is ON, the RF Attenuation is set by adjusting the acquisition. As the acquisition is lowered, for example from -10 dBm to -30 dBm, the FieldFox assumes that you are looking at low-level signals. The RF Attenuation value is automatically lowered in 5 dB steps to allow low-level signals to be viewed. The RF Attenuation value is never automatically lowered below 5 dB.

How to set Scale/Amptd

- Press **Scale/Amptd**.

Manually set Log or Linear Scale Type (Spectrum and RF Envelope Only)

Then select from the following:

- **More**
 - **Scale Type [current setting]** (Spectrum and RF Envelope Only)
 - **Log** Logarithmic scale (default setting). The Y-axis reference line represents the specified absolute acquisition in the current Unit selection. Y-axis graticules show dB below or above the reference line (default: 10 dB, minimum: 0.01 dB, maximum: 20 dB).
 - **Lin** Linear scale. The Y-axis reference line represents the specified absolute acquisition in the current Unit selection.
 - Y-axis graticules show percent of acquisition (%) below or above the reference line (Spectrum).
 - Y-axis graticules show voltage (V) – (RF Envelope).

Manually set Scale, Unit, Acquisition, and Reference Position.

- **Autoscale** Automatically adjusts the Y-axis to comfortably fit the Minimum and Maximum amplitude of the trace on the screen. Also, optimizes the FieldFox's signal level at the mixer and adjusts the reference level to with the autoscale settings.
- **Scale/Div** Manually adjust the scale per division to view specific areas of the current trace. Enter a value using the numeric keypad, the **▲▼** arrows, or the rotary knob. Then press **Enter**.

- **Ref Level** Manually set the value of the reference line. Enter a negative value by pressing **Run/Hold (+/-)** either before or after typing a value. Use acquisition in combination with the RF attenuator and the Preamp so that the signal at the acquisition is at the optimum level for the FieldFox (Spectrum and RF Envelope Only). This can also change the RF Attenuation setting (default: 0). See “**Attenuation Control**” on page 252.
- **Ref Pos** Manually set the position of the reference line. Values must be between 0 (TOP line) and 10 (BOTTOM line). Default position is zero (top) (default: 0, minimum: 0, maximum: 10).
- **More**, then
 - **Unit** Sets the display units.

Attenuation Control

Both the RF Attenuation and Preamp functions control the power level into the FieldFox mixer.

When too much power is present at the RF Input port, **ADC Over Range** appears on the FieldFox screen. This does not necessarily mean that damage has occurred, but that the receiver is probably compressed.

When high power levels are present at the RF Input port, internal attenuation can be switched in to keep the FieldFox receiver from compressing. At extremely high power levels, use external attenuation to protect the internal circuitry from being damaged.

CAUTION

The FieldFox can be damaged with too much power.

RF Damage Level: +25 dBm (N995xA & N996xA) and +27 dBm (all others)

DC Damage Level: ±50 VDC

The displayed power level is automatically adjusted for RF Attenuation. As the attenuation value changes, the displayed power level should NOT change.

How to set Attenuation

- Press **Scale/Amptd**.
- Then **RF Atten Auto Man**.
- **Auto** RF Attenuation is set by adjusting the input power level. As the acquisition is lowered, for example from –10 dBm to –30 dBm, the FieldFox assumes that you are looking at low-level signals. The RF Attenuation value is automatically lowered in 5 dB steps to allow low-level signals to be viewed.
- **Man** RF Attenuation is set manually. The default Attenuation setting is 10 dB. Enter a value between 0 to 30 dB in 5 dB steps using the numeric keypad, the **▲▼** arrows, or the rotary knob. Then press **Enter**

#Atten xx dB is shown at the top of the screen. (#) means manual setting.
(Default: 10 dB, minimum: 0 dB, maximum: 30 dB.)

Preamplifier Control (Opt 235)

When very low-level signals are analyzed, an internal preamplifier can be used to boost the signal level by approximately 18 to 22 dB. The gain of the preamp is NOT adjustable. The displayed signal level is automatically adjusted for the increase in system gain.

How to control the Preamp

By default, the preamp is OFF.

- Press **Scale/Amptd**.
- Then **More**
- Then **Preamp Off** The displayed setting is the current setting. When ON, **PA** is shown to the left of the graticules on the display (default: OFF). When OFF, nothing is displayed in the left graticules.

When Auto is selected, the preamp setting is determined by the RF attenuation and to the input power level. When the input power level reaches a certain value, the preamp is turned on and **PA** is shown to the left of the graticules on the display.

Using Markers (IQA)

The markers described here are for I/Q Analyzer mode (exceptions are noted). For additional marker features, refer to [“All about Markers” on page 438](#).

NOTE

IMPORTANT! When using I/Q markers, it is important to either be in Single acquisition mode or for Continuous acquisition mode, to set the measurement in advance on the FieldFox to Waveform or to Spectrum. Refer to [“How to Make Measurements Using the I/Q Analyzer Mode” on page 239](#).

The spectrum measurement's six markers can only be applied to a single displayed set of traces (Magnitude Spectrum).

The waveform measurement's six markers can be applied to any of the six displayed parameter traces (RF Envelope, I (Imaginary), Q (Real), Phase, Unwrapped Phase, or Polar).

See also [“Trace Display States \(IQA Mode\)” on page 259](#).

This section contains the following:

[“Noise Marker” on page 254](#)

[“Band/Interval Power Marker” on page 255](#)

[“Band Span Marker \(Spectrum Only\)” on page 256](#)

[“Interval Span Marker \(Waveform Only\)” on page 256](#)

[“Coupled Markers \(Waveform Only\)” on page 256](#)

[“Continuous Peak Search Marker” on page 258](#)

Noise Marker

For comparison purposes, electronic noise measurements are often displayed as though the measurement was made in a 1 Hz Res BW. However, making an actual measurement at a 1 Hz Res BW is extremely slow.

A Noise Marker mathematically calculates the noise measurement as though it were made using a 1 Hz bandwidth.

Several data points are averaged together to calculate the Noise Marker readout. To accurately measure noise, the Noise Marker should NOT be placed on, or too close to, a signal. The distance from a signal depends on several factors. To know if an accurate reading is being made, move the Noise Marker until consistent measurements are displayed in adjacent data points.

With a Noise Marker present, the Res BW can be changed and the displayed noise floor will also change, but the Noise Marker readout will remain about the same.

Noise Markers can be used like regular markers. A Noise Marker is distinguished from a regular marker by **(1Hz)** after the marker readout value. Learn more about regular markers in **“All about Markers” on page 438**.

How to measure Noise with a marker

- Press **Marker** to create or select a Normal or Delta marker to use to measure Noise.
- Then **More**.
- Then **Marker Function**
- Then **Noise**.

Band/Interval Power Marker

A Band/Interval Power marker—available in IQA and SA Modes—integrates the power that is measured over several adjacent data points. The range of points being measured is displayed with vertical posts around the marker. This Band Span value is selectable.

This feature is very similar to a channel power measurement (see SA chapter, **“Channel Power (CHP)” on page 192**).

When the IQA is set to a waveform measurement, the marker is referred to as an Interval Marker because it averages power over a specific time interval. In this case the range is specified as the Interval Span.

How to measure Band/Interval Power with a marker

- Press **Marker** to create or select a Normal or Delta marker to use to measure Band/Interval power.
- Then press **More**
- Then **Marker Function**
- Then **Band/Int Power**
- Then **Band Span** (Spectrum) or **Interval/Span** (Waveform)
- Then choose from the following:
 - **Auto** Measures power over 5% of the displayed span, or ½ graticule. The Band Span is automatically updated to remain at 5% when you change the frequency span.
 - **Man** Enter a frequency or time value using the **▲▼** arrows or the rotary knob, then press **Enter**. Or enter a value using the numeric keypad and select a frequency or time suffix. The Band Span remains at the frequency or time value that you set as the span changes.

Band Span Marker (Spectrum Only)

Sets the width of the span (Hz) for the selected marker.

How to measure with the Band Span marker

- Press **Marker** to create or select a Normal or Delta marker to use to measure Band/Interval Power.
- Then press **More**
- Then **Marker Function**
- **Band Span** Enables or disables the Band Span marker (default: 500 kHz, minimum: 1 Hz, maximum: 10 MHz).

Interval Span Marker (Waveform Only)

Sets the width of the interval span (seconds) for the selected marker.

How to measure with the Interval Span marker

- Press **Marker** to create or select a Normal or Delta marker to use to measure Band/Interval power.
- Then press **More**
- Then **Marker Function**
- **Interval Span** Enables or disables the Band Span marker (default: 5% of the (start time – stop time), minimum: 1 ns, maximum: 10s).

Coupled Markers (Waveform Only)

When a Coupled marker is enabled in a window on the FieldFox, the current active marker in that window is enabled as the 'reference' coupled marker on the current trace and the x-axis value of any other active waveform markers on any other traces in other windows are updated to track that of the 'reference' coupled marker. Refer to [Figure 11-2 on page 257](#).

How to measure with the Coupled marker

- Press **Marker** to create or select a Normal, Delta, or Peak marker to use the Coupled Marker.
- Then **More**
- Then **Coupled Markers** Enables or disables the coupled marker (default: OFF).

Procedure to set coupled markers (Refer to [Figure 11-2 on page 257](#)):

1. Press **Preset** > **Mode Preset (Factory)**
2. Press **Measure 1** > **User Defined**

Four windows are displayed (Spectrum, Waveform, Real, and Imaginary)

3. Using the $\blacktriangle/\blacktriangledown$ arrows or the rotary knob, move so Window 2 Waveform is selected (green border).
4. Press **Marker** > **Marker 1** > **Normal**
5. Press **Esc**
6. Repeat steps 3 through 5 while selecting the other measurement windows and markers:
 - Real using marker 2 and
 - Imaginary using marker 3
7. Press **Marker** > **More** > **Coupled Markers ON**
8. Press **Marker** and use the $\blacktriangle/\blacktriangledown$ arrows or the rotary knob to move the coupled markers along the traces in Window 2 (Waveform), Window 3 (Real), and Window 4 (Imaginary).

Figure 11-2 IQ Analyzer (IQA) Display - Coupled markers with Waveform (marker 1), Real (marker 2), and Imaginary (marker 3) displays

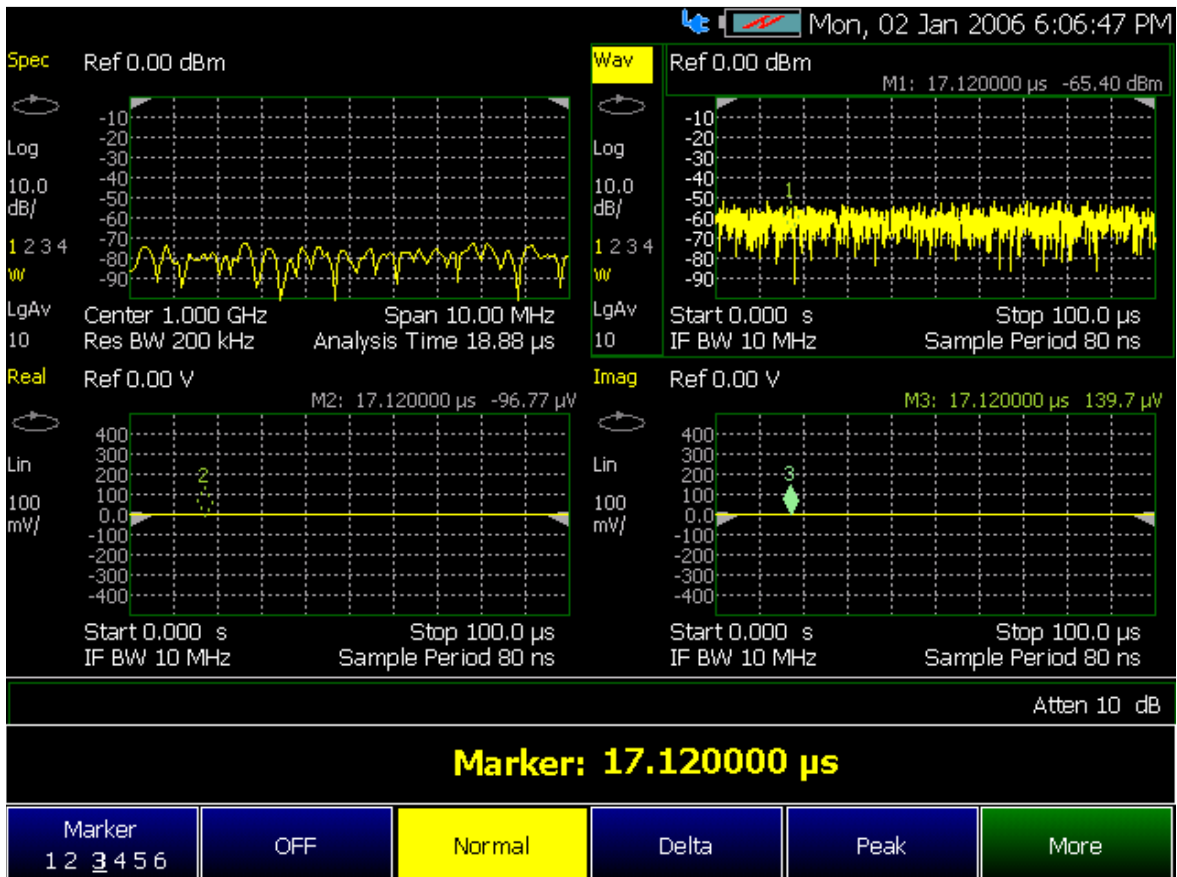

Continuous Peak Search Marker

When the Continuous Peak Search marker is on, a peak search is automatically performed for the selected marker after each acquisition. For additional marker functionality, refer to **“All about Markers” on page 438**.

Summary:

- **Cont Peak Search** Enables or disables the continuous peak search
- The rules for finding the peak are exactly the same as for Peak Search, including the use of peak criteria rules.

How to measure with the Continuous Peak Search marker

- Press **Mkr->/Tools** to create or select a Normal or Delta marker to use the Continuous Peak Search marker.
- Then press **More** (RF Spectrum Only)
- Then press **Mkr Properties**
- Then **Peak Criteria**
- Then **Cont Peak Search** Enables or disables the Continuous peak search marker (default: OFF).

Alignments

The IQA mode requires all three alignment types: amplitude, RF burst, and channel equalization. Refer to the SA chapter's **“Alignments” on page 177** for information on all alignments.

Trace Display States (IQA Mode)

NOTE

If you have Option 351 I/Q Analyzer option, you can directly save your data as MATLAB files (*.mat). Refer to **Chapter 11, “IQ Analyzer (IQA) – Option 351 (CPU2 Only)”**, on page 235 and to **Chapter 27, “File Management”**, on page 497.

If you have the FieldFox's Remote Server mode (89600 VSA software connectivity), you can use the VSA software to capture and record your data as MATLAB files (*.mat). Learn more about FieldFox and 89600 VSA software, refer to **Chapter 12, “Remote Server Mode (Requires CPU2 and SA Hardware/SA Option 233)”** and to <http://rfmw.em.keysight.com/wireless/helpfiles/89600B/WebHelp/89600.htm>.

- In IQA Mode you can display up to four of the following types of trace states. All IQA settings are applied to all displayed traces. See also **“Marker Trace (IQA and SA Mode)” on page 442**.

A color-coded legend for displayed traces is visible in the left pane of the SA mode screen:

W = Clear/Write; **M** = MaxHold; **m** = MinHold; **A** = Average; **V** = View

How to display the Trace States

- Press **Trace 6**.
- Then **Trace 1,2,3,4** repeatedly to select a trace number to display or change its state. Traces are displayed in the following colors:
 - Trace 1 – **Yellow** Trace 2 – **Blue**
 - Trace 3 – **Orange** Trace 4 – **Green**
- Then **State [current setting]**
- Then choose from the following Trace States:
 - **Clr /Wr** (Clear/Write) Displays the actual measured data for each acquisition.
 - **MaxHold** Displays the maximum response of the input signal at each data point over multiple acquisitions. See also Average Count in **“Adjusting the Measurement Setup Settings” on page 248**.

- **MinHold** Displays the minimum response of the input signal at each data point over multiple acquisitions. See also Average Count in **“Adjusting the Measurement Setup Settings” on page 248.**
- **Average** Each data point is averaged over multiple acquisitions as set by the Average Count setting. Learn more in **“Adjusting the Measurement Setup Settings” on page 248.**
- **View** Displays and then holds the last complete measurement trace on the screen. This is similar to storing a trace in memory.
- **Blank** Displays no trace.

Other Features Available

- **External Gain** - Refer to refer to the SA chapter's section, "**External Gain**" on page 152.
- **Limit Lines** - For information on using Limit Lines, refer to "**All about Limit Lines**" on page 453.
- **Display Lines** - For information on using Limit Lines, refer to the SA chapter's section, "**Display Line**" on page 186.

IQ Analyzer (IQA) – Option 351 (CPU2 Only)
Other Features Available

12 Remote Server Mode (Requires CPU2 and SA Hardware/SA Option 233)

Remote server mode enables you to connect your FieldFox to compatible PC-based licensed software applications (e.g., 89600 VSA software¹). Refer to <http://www.keysight.com/find/assist>.

NOTE

FieldFox with a Remote Server mode (available with FieldFox firmware \geq A.10.00) does not display a mode softkey, because Remote Server mode is only enabled when you have a SA Option 233 on the FieldFox, compatible 89600 VSA software license loaded and running on a remote PC, and connected via LAN to your FieldFox. (i.e., Requires 89600 VSA software version \geq 22.01). Refer to <http://www.keysight.com/find/assist>.

When in Remote Server mode, **most** of the front panel hardkeys are locked and will beep, but perform no actions when pressed (i.e., the FieldFox front panel hardkeys are not relevant when connected via LAN to the 89600 VSA software on your remote PC). In Remote Server mode only:

- **System 7** hardkey lets you change the system settings
- **Esc** (escape) hardkey lets you forcefully disconnect from the PC-based software

To **gracefully** disconnect (recommended) from the software, exit using the PC-based software's disconnect option or shutdown the software. Refer to [“Initial Waiting for a Connection from a PC-based and Compatible Licensed Software or No Remote Connection” on page 265](#).

If you to attempt connect a non-compatible FieldFox you will see the following error message:

“Error: 38, The requested functionality is not available.”

1. To order the 89600 VSA Software, refer to <http://www.keysight.com/find/assist>.

Remote Server Mode (Requires CPU2 and SA Hardware/SA Option 233)
In this Chapter:

In this Chapter:

[“Connecting Using Remote Server” on page 265](#)

[“89600 VSA Software Overview \(Requires CPU2 and N991xA/3x/A5x/A6xA and SA Option 233\)” on page 267](#)

See Also

Optional Settings:

[“LAN Settings” on page 488](#)

[“All about Markers” on page 438](#)

[“All about Limit Lines” on page 453](#)

[“All about Trace Math” on page 458](#)

Connecting Using Remote Server

This section provides an overview of the FieldFox's Remote Server mode instrument display messages that occur during the remote connection process. For more information on specific compatible PC-based licensed procedures refer to:

- **“89600 VSA Software Overview (Requires CPU2 and N991xA/3x/A5x/A6xA and SA Option 233)” on page 267**

Figure 12-1

Initial Waiting for a Connection from a PC-based and Compatible Licensed Software or No Remote Connection

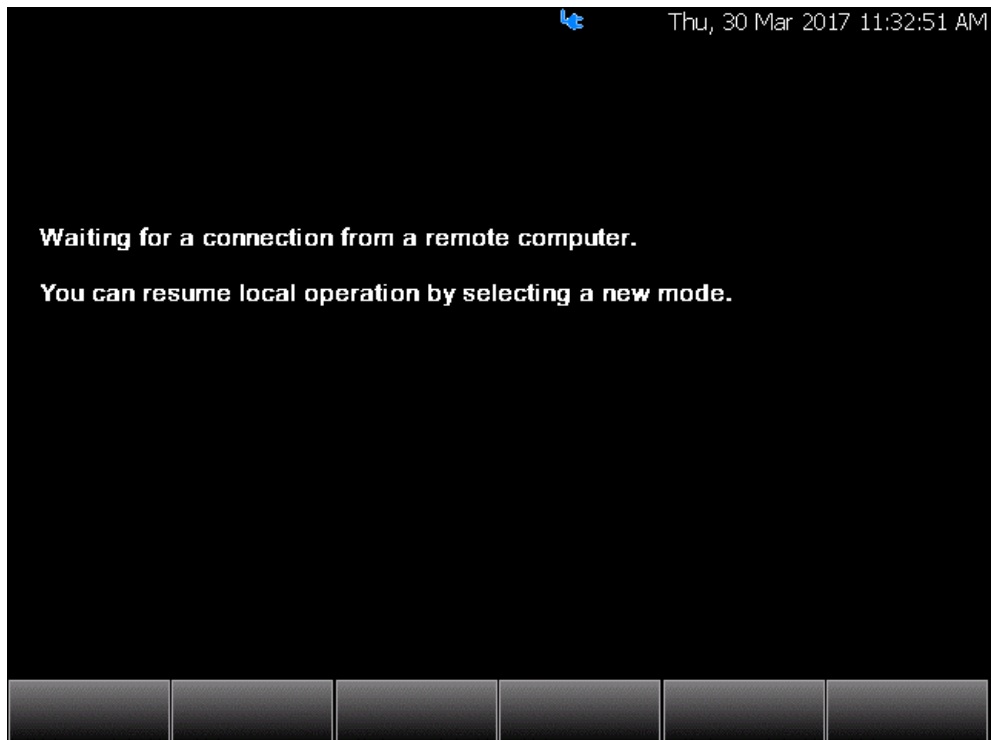

The graphic above shows the FieldFox in the process of connecting to a PC-based and compatible licensed software.

Figure 12-2

FieldFox Display When Remotely Connected to a PC-based Software

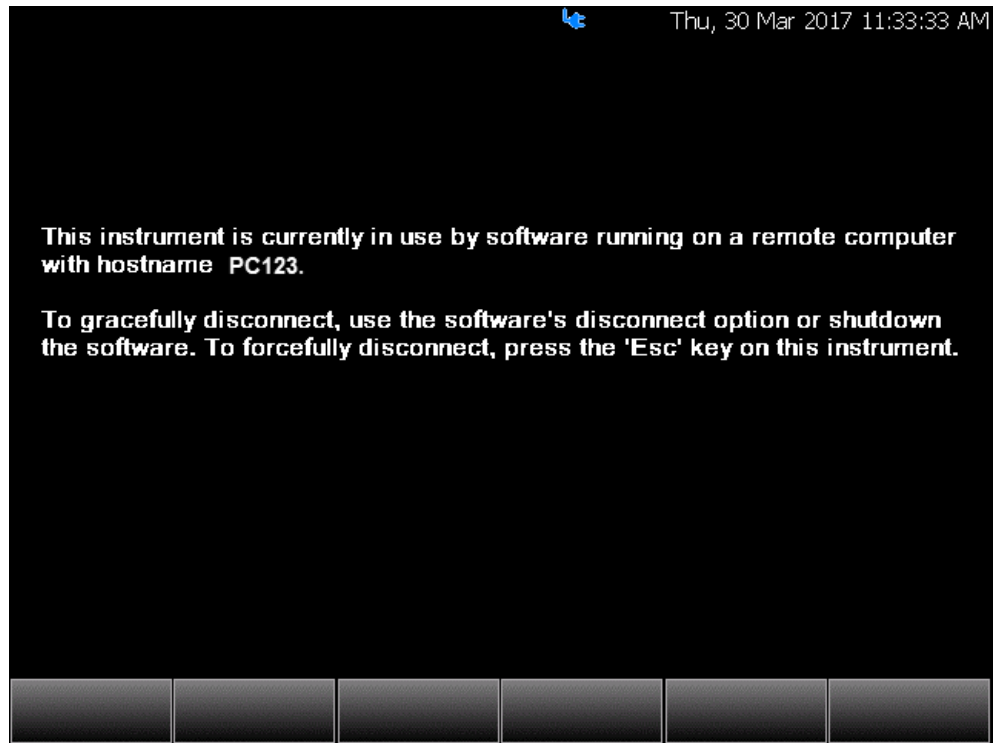

The graphic above shows the FieldFox successfully connected to a PC—with an example hostname "PC123"—and to a compatible licensed PC-based software.

89600 VSA Software Overview (Requires CPU2 and N991xA/3x/A5x/A6xA and SA Option 233)

NOTE

IMPORTANT! The following is a description of the 89600 VSA Software's overall capabilities. Your instrument may not have all of the hardware and firmware required to use all of the 89600 VSA Software's listed features.

The FieldFox remote server mode, requires 89600 VSA Software with firmware version ≥ 22.01 .

NOTE

If you have the FieldFox's Remote Server (89600 VSA software connectivity), you can use the VSA software to capture and record your data as MATLAB files (*.mat). Learn more about FieldFox and 89600 VSA software, refer to <http://www.keysight.com/find/assist>.

If you have Option 351 I/Q Analyzer option, you can directly save your data as MATLAB files (*.mat). Refer to [Chapter 11, "IQ Analyzer \(IQA\) – Option 351 \(CPU2 Only\)", on page 235](#) and to [Chapter 27, "File Management", on page 497](#).

Connecting the FieldFox remotely to a PC running the 89600 VSA software, will start the FieldFox's Remote Server mode. The 89600 VSA software is powerful, PC-based software, offering the industry's most sophisticated general purpose and standards specific signal evaluation and troubleshooting tools for R&D engineers. Even for proprietary and non-standard signals in SATCOM or MILCOM applications, you can make signal quality measurements with customized IQ constellation. Reach deeper into signals, gather more data on signal problems, and gain greater insight.

- General-purpose analog and digital demodulators ranging from 2FSK to 4096QAM
- Flexible and custom IQ and OFDM signal analysis
- Standards specific modulation analysis including:
 - Cellular: 5G, LTE & LTE-Advanced (FDD, TDD), W-CDMA, GSM/EDGE, cdma2000, 1xEV-DO, TD-SCDMA,
 - Wireless connectivity: 802.11ax, 802.11n/ac, 802.11a/b/g/j/p, 802.16 WiMAX (fixed/mobile), 802.15.4 Wi-SUN
 - RFID
 - Digital satellite video and other satellite signals, radar, LMDS
- Up to 400K bin FFT, for the highest resolution spectrum analysis
- A full suite of time domain analysis tools, including signal capture and playback, time gating, and CCDF measurements
- Unlimited trace displays and the industry's most complete set of marker functions

Remote Server Mode (Requires CPU2 and SA Hardware/SA Option 233)
89600 VSA Software Overview (Requires CPU2 and N991xA/3x/A5x/A6xA and SA
Option 233)

- Easy-to-use Microsoft Windows graphical user interface

For a comprehensive FieldFox VSA mode help, refer to
<http://rfmw.em.keysight.com/wireless/helpfiles/89600B/WebHelp/89600.htm>

For additional information on the 89600 VSA Software brochure, refer to
<http://literature.cdn.keysight.com/litweb/pdf/5990-6553EN.pdf>

For Technical Overview, refer to
<http://literature.cdn.keysight.com/litweb/pdf/5990-6405EN.pdf>

13 Interference Analyzer (SA Mode) – Option 236

Option 236 provides Spectrogram display, Waterfall display, and Record/Playback.

In this Chapter

[“Spectrogram Display \(SA Option\)” on page 270](#)

[“Common Settings for Waterfall and Spectrogram” on page 272](#)

[“Waterfall Display” on page 273](#)

[“About Sessions” on page 275](#)

[“FieldFox Setting Changes during Record and Playback” on page 276](#)

[“About State and User Tags” on page 277](#)

[“How to Record a Session” on page 278](#)

[“How to Playback a Session” on page 279](#)

[“Recording Configuration” on page 279](#)

[“Playback Configuration” on page 283](#)

[“Manage Sessions” on page 283](#)

[“Record Playback Example \(SA Only\)” on page 284](#)

Spectrogram and Waterfall Displays

Spectrogram and Waterfall displays provide a visual history of the measured spectrum. Each display type can be used to locate intermittent signals or to view signal levels and frequencies over time.

Spectrogram is a single horizontal line of color-coded power while Waterfall uses a 3-D color-coded display. The functional difference between these two displays is that Spectrogram provides less trace detail than Waterfall display. However, it also allows more traces to be viewed.

These two displays can NOT be used with Channel Measurements.

In SA mode, Traces can be recorded from, or played back into, any measurement type (such as Channel Power or Occupied BW) or any display type (such as Spectrogram and Waterfall). See **“How to Record a Session”** on **page 278** to learn how to save traces.

Spectrogram Display (SA Option)

Spectrogram draws the most recent trace record at the bottom of the stack of previously-drawn trace records. Drawing the live trace on the display is optional.

Figure 13-1

Spectrogram display- Overlay view- with time markers 23 seconds apart.

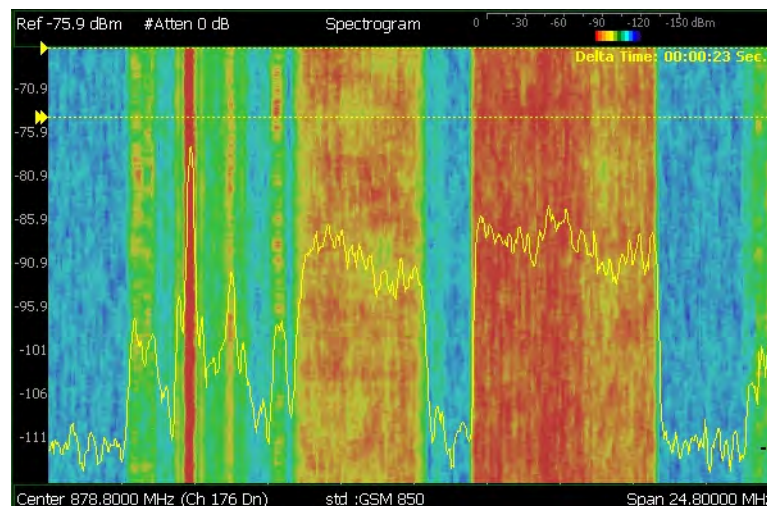

The following settings all contribute to the sweep time of an individual trace, and therefore, the total elapsed time that can appear on the screen in Spectrogram display:

- Frequency Range. Learn more in **“Frequency Range”** on **page 146**.
- Resolution BW and Video BW. Learn more in **“Resolution Bandwidth (Res BW)”** on **page 163** and **“Video Bandwidth (Video BW)”** on **page 164**.
- Sweep Time (Acquisition). Learn more in **“Sweep Acquisition”** on **page 166**

- Resolution (Number of Points). Learn more in [“Points ” on page 174](#).

How to select Spectrogram

- Press **Meas 1**
- Then **Interference Analysis**
- Then **Spectrogram**

How to modify the Spectrogram

You can change how the spectrogram is displayed relative to the data trace. This setting affects the total number of trace records that can be displayed.

For SA Mode:

- Press **Meas Setup 4**.
- Then **Spectrogram Settings**
- Then **Spectrogram View**
- Then choose from the following:
 - **Overlay** Displays the data trace over the spectrogram with NO graticules. Total trace records: 340.
 - **Full Screen** Displays the spectrogram with NO data trace. Total trace records: 340.
 - **Top** Displays the data trace below the spectrogram. Total trace records: 130.
 - **Bottom** Displays the data trace above the spectrogram. Total trace records: 130.

How to create Time Markers (SA Only)

Use Time Markers to determine the elapsed time between any two displayed records. The most recent record appears at the bottom of the screen.

- Press **Meas Setup 4**
- Then **Time Markers**
- Then **Time**
- Then enter a value from 0 (the most recent sweep record) to the maximum value, using the numeric keypad, **▲▼** arrows, or the rotary knob. A **>** indicates the Time Marker.
- Then **Delta**
- Then enter a value from 0 (the most recent sweep record) to the maximum value, using the numeric keypad, **▲▼** arrows, or the rotary knob. A **>>** indicates the Delta Marker.

- At the current sweep speed, the difference in time between these two markers appears at the upper-right corner of the view as **Delta Time: hh:mm:ss Sec**.
- An invalid number (very large positive or negative) appears when a trace record is not available at either marker. 00:00:00 Sec appears when both markers are not available.

Common Settings for Waterfall and Spectrogram

NOTE

Waterfall settings only apply to the SA option.

Set Red and Blue Limits

The colors displayed on the Waterfall and Spectrogram represent the various measured power levels:

- Red = Highest power levels
- Blue = Lowest power levels

NOTE

The full Red-to-Blue color spectrum is visible only with Indoor display colors. Learn more in [“Display Colors” on page 467](#).

Adjust the Red and Blue limits to the power levels that you expect to measure.

The Blue limit must always be less than the Red limit.

For SA Mode:

- Press **Meas Setup 4**.
- Then **Spectrogram Settings** or **Waterfall Settings**
- Then choose from the following:
 - **Red Limit** Using the **▲▼** arrows, rotary knob, or keypad, select the HIGHEST power level that you expect to measure. This power level, and those measured higher than this level, appear Red.
 - **Blue Limit** Using the **▲▼** arrows, rotary knob, or keypad, select the LOWEST power levels that you expect to measure. This power level, and those measured lower than this level, appear Blue.

How to Restart the Spectrogram/Waterfall

Press **Sweep 3** then **Restart**

Averaging

Averaging can be enabled on the underlying measurement. Press **Meas 4** then **Average Type**. Learn more in [“Average Type” on page 176](#).

Measurement Preset

Measurement Preset resets ONLY the Spectrogram and Waterfall display settings. It does not reset the measurement settings.

- Press **Preset**
- Then **Meas Preset**

Waterfall Display

The live trace is always drawn on a Waterfall display. Older trace records scroll up from the displayed trace and eventually off the screen. Because of this, locate the live trace on the bottom of the screen using the scale and reference settings. Learn how in [“Scale and Units” on page 151](#).

NOTE

Although this document refers to past traces as ‘records’ these traces are not saved. They are only drawn on the FieldFox screen. See [“Record Playback Example \(SA Only\)” on page 284](#) for how to save traces.

Figure 13-2

Waterfall display- moderate angle- with time markers 1 minute apart.

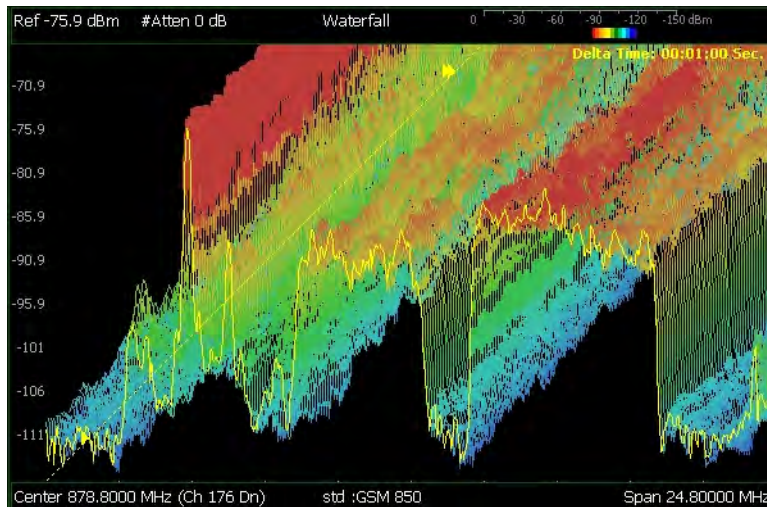

The following settings all contribute to the sweep time of an individual trace, and therefore, the total elapsed time that can appear on the screen in Waterfall display:

- Frequency Range. Learn more in [“Frequency Range” on page 146](#).
- Resolution BW and Video BW. Learn more in [“Resolution Bandwidth \(Res BW\)” on page 163](#) and [“Video Bandwidth \(Video BW\)” on page 164](#).
- Sweep Time (Acquisition). Learn more in [“Sweep Acquisition” on page 166](#)

- Resolution (Number of Points). Learn more in [“Points ” on page 174.](#)

Waterfall Angle

This setting allows you to show more or less detail. More detail provides fewer (time) records.

- Press **Meas Setup 4**
- Then **Waterfall Settings**
- Then **Waterfall Angle**
- Then choose from the following:
 - **Moderate** Compromise between detail and number of records.
 - **Steep** Least detail with highest number of records.
 - **Gradual** Most detail with lowest number of records.
 - **Wide Angle** Moderate angle with increased space between records.

Learn how to set **Red and Blue Limits** in [“Set Red and Blue Limits” on page 272.](#)

Record/Playback (SA Option)

Record Playback allows you to record SA trace sweeps and play them back at a later time. Use this feature to monitor spectrum activity over a period of time.

You can record traces continuously, record a specified number of traces (segments), or record when triggered by a specified power level.

Traces can be recorded from, or played back into, any measurement type (such as Channel Power or Occupied BW) or any display type (such as Spectrogram and Waterfall).

When GPS is enabled, the current location and elevation are saved and played back with traces.

Recordings can be saved to the FieldFox Internal memory, an SD Card, or a USB flash drive.

About Sessions

A Recording Session is a collection of recorded traces and the instrument states that generated them.

Before recording can occur, a new session must be initiated or an existing session must be opened. Sessions can later be opened for playing or continued recording. Only one session can be open at a time.

You close the session when finished recording or playing. A session is also closed when the FieldFox is Preset (or Mode Preset), an Instrument State is recalled, or when Mode is changed from SA.

Each session is saved as a folder containing a set of files on the specified storage device.

How long can a recording session last?

There are many variables that determine the possible length of a recording session. But one key variable is the amount of available memory.

When a session is opened or a new session is initiated, an estimate is made of the maximum number of traces that can be saved based on the available disk space and the current number of data points (resolution). Recording will stop when that number is reached. This estimate always keeps 4 MB of available disk space on the specified storage device. You can decrease the number of traces to further limit recording. The resolution setting can NOT be changed after a session is opened.

To maximize the amount of space that is available, save recorded traces to a USB Flash drive or SD card. Learn how in **“Manage Sessions” on page 283**.

You can determine the length of time over which recording can occur by setting the Record Interval (the time between recorded traces) and other settings. Learn more in **“Recording Configuration” on page 279**.

To view and edit the maximum number of records

Just after opening or initiating a session...

- Press **Session Data**
- Then **TraceRecordLimit <n>** (n = Max number of traces that can be recorded).
- **Clear All Records** Empties that session of recorded traces. Learn more in **“Manage Sessions” on page 283**.

FieldFox Setting Changes during Record and Playback

During Recording

When any of the following State settings are changed during recording, the State counter is incremented (**“About State and User Tags” on page 277**) and the settings are saved to the Session file along with the first trace to be recorded with the new setting. During playback, the trace and display annotation will reflect the change on the screen.

State settings:

Refer to **Table 13-1** for a list of the applicable state settings for the SA option.

Table 13-1

Summary of SA State Settings

Option	Settings
SA	
	Average Type
	Detector(s)
	External Gain
	Frequency Range
	Preamplifier On/Off
	Resolution BW
	RF Attenuation
	Source Settings
	Sweep Acquisition
	Trigger Settings
	Video BW
	Zero Span Sweep Time

Other display settings, such as Scale and acquisition, can also be changed during recording but are not saved with the session file. Think of these as settings that help YOU see the recording and playback activity. They do NOT change the data that is recorded.

During Playback

The State setting changes listed above are NOT allowed during playback.

However, all other display settings can be changed during playback to help you analyze the recorded data.

In SA mode, when recordings are played back further trace processing is possible. The Trace State(s) can be modified for post processing, and different measurements such as Channel Power, Occupied BW, Spectrogram, and Waterfall can be activated. This is because in SA all these measurements are derived from the raw traces. If not compatible with the measurement type, a **MEAS UNCAL** message will appear on the screen.

Record/Playback Exceptions

- Markers can be activated and moved to help analyze recorded data. However, marker position control is only available when playback is Paused.
- Field Strength Corrections is saved with the session file and it is also allowed during playback. Learn about this Field Strength Corrections in **“Field Strength Measurements” on page 154.**
- Frequency Counter at Marker is NOT allowed during Recording or Playback. Learn about this feature in **“Frequency Counter at Marker” on page 188.**

About State and User Tags

When any of the State settings (listed above) are changed during a recording, a ‘state tag’ is inserted at the first trace number to be recorded with the new setting.

In addition, you can insert a ‘User Tag’ at any time during a recording session to indicate an external event, such as when an antenna is moved. During playback, you can move quickly to any of these tags, or scroll through these tags.

A symbol is used on the screen annotation to distinguish a User Tag from a State Tag when scrolling through tags during playback.

Screen Annotation

During a record or playback session, the following is displayed in the top-left area of the screen:

- **AutoSession02: 92/95 (state 4/5) * _**
Sep.22.2009 09:15:15 AM

where:

- **AutoSession** is an auto-generated name for sessions. **02** is the auto-generated number, incremented with each new session. The name can be changed using Manage Sessions. Learn more in [“Manage Sessions” on page 283](#).
- **92/95** is the current and total trace number: currently trace is 92 of 95 total traces.
- **state 4/5** is the current and total state tag or user tag number: 4 of 5 total tags.
- ***** (Asterisk) indicates that a state has changed. **#** (Pound) indicates that a User Tag has been inserted.
- **Sep.22..** is the date and time of recording.

When GPS is enabled, the current location and elevation are annotated at the bottom of the playback display. Learn more in [“GPS” on page 475](#).

NOTE

If Recording or Playback is not occurring when you think it should, check the following:

- Is the sweep in **HOLD**? (upper-left annotation)
- Is Recording or Playback **Paused**? (mid-left annotation)
- Is the Record or Playback **Interval** set too long? (Configuration settings.)

How to Record a Session

- Press **Trace 6**
- Then **Record Playback**
- SA Only: Optionally set resolution (points). Learn how in [“Points ” on page 174](#). This can NOT be changed after a session is opened.
- Then either:
 - **New Session** OR
 - **Recall Session** then **Open** and select a session.
- Then **Recorder Player**
- Then **Record**

REC is displayed in the left of screen graticules.

During recording, choose from the following:

- **Pause Resume** Temporarily halts recording until pressed again. The incoming trace continues to sweep. Press again to continue recording.
- **Stop** Immediately stops recording. Then choose from the following:
 - Press **Play** to start replaying the recording from the beginning.

- Press **Record** to continue recording.

How to Playback a Session

- Press **Trace 6**
- If the session is already open, skip the following step. Otherwise:
- Then **Record Playback Setup**
 - Press **Recall Session** Then select a session to playback and press **Open**.
- Then **Recorder Player**
- Then **Play**

PLAY is displayed in the left of screen graticules during playback. When the end of the recording is reached, playback begins again at trace 1 and continues to loop indefinitely.

During playback, choose from the following:

- **Pause Resume** Temporarily halts playback. Then choose from the following:
 - **Pause Resume** Press to continue playing.
 - **Playback State/Tag** Allows you to continue playback from a state tag, or scroll through the state tags. Enter a value between 1 and the total number of state tags using the numeric keypad, **▲▼** arrows, or the rotary knob. Active when playback is paused. Learn more in **About State and User Tags** in **“About State and User Tags” on page 277**.
 - **Playback Trace** Activated automatically when Paused. Allows you to continue playback from a specific trace, or scroll through traces manually. Enter a value between 1 and the total number of traces using the numeric keypad, **▲▼** arrows, or the rotary knob.
- **Stop** Immediately stops playback. Then choose from the following:
 - **Play** Start playback from trace 1.
 - **Record** Resume recording from the last recorded trace.
 - **Record Playback Setup** Return to the setup menu to change Configuration settings or Close the session.

Recording Configuration

To change Recording Configuration settings:

- Press **Trace 6**

- Then **Record Playback**
- Then **New Session** or **Recall** an existing session.
If **New Session** is selected:
 - Then **Session Data** and choose one of the following:
 - Then **CSV SaveStyle**
 - **Single Trace** (default) saves the currently displayed trace.
 - **Range Traces** saves the currently displayed trace. This selection requires you to manually select a range of traces to be recorded in the Playback Configuration menu. Refer to **“Playback Configuration” on page 283**.
 - **AllTraces** saves all traces.
 - Then **TraceRecordLimit** to change the maximum recording file size.
 - Then **Clear AllRecords** to clear all traces out of memory.
 - Then **Back** to return to previous menu.
- Then **Recording Configuration**

Then choose from the following:

- **Record Time** Sets the amount of time to record traces. Default is MAX, which is to record indefinitely. Enter a value between 1s and 1 Ms (million) seconds using the numeric keypad, **▲▼** arrows, or the rotary knob. When set, a timer appears during recording in the lower-left corner which counts DOWN from the specified time.
- **Record Source** Sets where, in the FieldFox data flow, data is recorded. Learn more in **“Record Source” on page 282**. Choose from the following:
 - **RawMeas** Records raw measurement data.
 - **Trace 1,2,3,4** Records data from the corresponding trace in its current state.
- **Record Interval** Sets the amount of time to wait between individual trace recordings. Default is MIN, which is to wait 0 seconds (record traces as fast as possible). Enter a value in seconds between 0 (no delay) and 10,000 seconds - about 3 hrs) using the numeric keypad, **▲▼** arrows, or the rotary knob.
- **Segment Count** Sets the number of traces to record, after which the recording will automatically pause. Press Pause/Resume or Record to capture another N traces, or Stop to end recording. Default is OFF, which is NO limit to the number of traces to be recorded.

When set, a counter appears in the lower-left corner which counts UP to the specified number of recordings.

– **FreqMaskTrigger OFF ON**

Sets the power level which will trigger a recording. Set these power levels (mask) exactly as you would set Limit Lines. (See “**All about Limit Lines**” on page 453.) With **Record ON**, when any data point measurement is higher than an upper limit, or lower than a lower limit, recording begins. See Frequency Mask Trigger Configuration in the following section to learn how to configure the mask.

Typically you would use FreqMaskTrigger with Segment Count, but it can also be used with Record Time and Record Interval.

When used with **Segment Count**:

- When a mask limit is exceeded, subsequent traces are recorded until the specified segment count is reached. Once segment count is reached, exceeding another mask limit will again cause traces to be recorded until the segment count is reached, and so forth.
- To record only those traces that exceed the limit, set Segment Count to 1
- To record ALL traces after a limit is exceeded, set Segment Count OFF.

When used with **Record Time**, the timer counts down even when traces are not being recorded (limits are not being exceeded). Recording starts when a limit is exceeded and stops when the timer reaches 0.

When used with **Record Interval**, a trace is recorded when a limit is exceeded, then no recordings during the specified ‘wait’ interval, then the next trace is recorded, followed by another time delay, and so forth. This pattern repeats indefinitely if Segment Count is OFF, or (if ON) until Segment Count is reached.

Frequency Mask Trigger Configuration (SA Mode Only)

Create or recall a Frequency Mask to be used with the FreqMaskTrigger feature.

NOTE

Frequency Mask Trigger only applies to SA mode.

NOTE

The Mask file is saved to, and recalled from, the Save /Recall Storage Device location – NOT from the Record Playback Storage Device location. These are two different settings. Learn how to set the Save /Recall Storage Device in “**Set File Type and Select Device**” on page 503.

A mask that is in use during a recording is NOT saved with the recording and does NOT automatically appear during playback. Like Limits Lines, it is saved and recalled with a state file.

Although they are created in the same manner, Limit Line files and FreqMask files can NOT be used interchangeably.

- Press **Trace 6**
- Then **Record Playback**
- Then **New Session** or **Recall** an existing session. The current mask appears as soon as a session is opened.
- Then **FreqMaskTrigger Configuration**
- Then choose from the following
 - **Edit Mask** Create or modify the current mask. Learn how to edit the Mask / Limit Line table in **“All about Limit Lines” on page 453.**
 - **Save Mask** Saves the current mask to a file.
 - **Recall Mask** Loads a mask file.

Record Source

NOTE

The RawMeas data setting only applies to SA Mode.

For SA mode, the simplest way to use Record Playback is to record RawMeas data, which can then be played back into all of the current Trace States.

However, for more complicated processing, refer to the following diagrams. These figures illustrate where in the FieldFox data flow data is recorded and played back.

NOTE

For this discussion, it is important to understand Trace States. Learn more in **“Trace Display States (SA Mode)” on page 175.**

Figure 13-3

FieldFox SA Mode: Data Flow and Record Playback Data Points

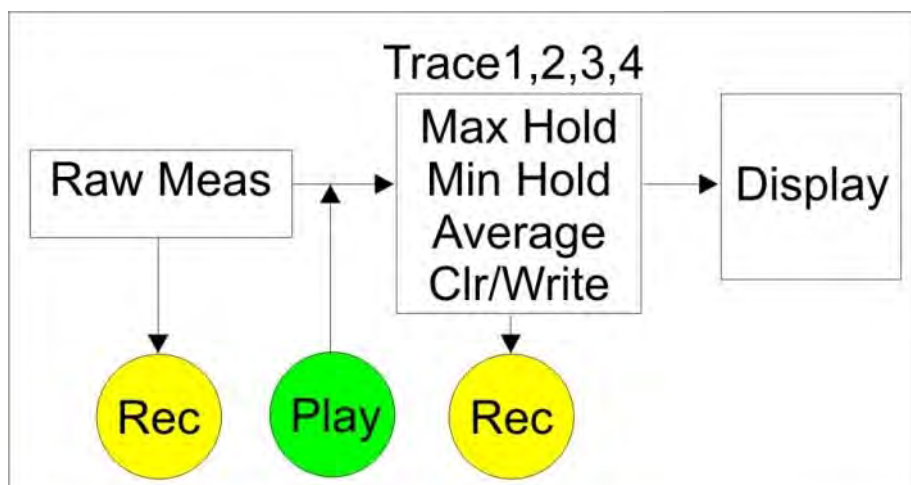

SA Data Recording:

- Data can be recorded at the **Raw Meas** block where data is acquired after ResBW, VideoBW, and Detector processing, but before any trace state processing.
- Data can be recorded from Traces 1,2,3, or 4 which includes the trace state (Max Hold, Min Hold, and so forth).
- Recording from a Clear/Write trace yields exactly the same data as recording from the Raw Meas block.
- Data is ALWAYS played back at the same location in the data flow: just after the Raw Meas block, through all currently active Traces, and onto the display.
- See an **example** using Record Playback with Max Hold traces in **“Record Playback Example (SA Only)” on page 284.**

Playback Configuration

By default, trace sweeps are played back as fast as the trace can be drawn on the screen. The following setting allows you to slow playback. In addition, you can manually scroll through individual traces using Playback Trace, or scroll through State and User Tags using Playback State/Tag. Learn more in **How to Playback a Session** in **“How to Playback a Session” on page 279.**

To slow playback of a session:

- Record a new session or Open an existing session.
- Press **Playback Configuration**
- Then **Playback Interval**
 - Enter a value in seconds between 0 (no delay) and 100 using the numeric keypad, **▲▼** arrows, or the rotary knob. After using the keypad, select a multiplier key. Learn about multiplier abbreviations.
 - Press **Enter**
- **First Trace** to define the first trace in a Range of traces to be recorded/played/saved.
- **Last Trace** to define the last trace in a Range of traces to be recorded/played/saved.
- **Back** to return to the previous menu.

Manage Sessions

- Press **Trace 6**
- Then **Record Playback**

- Then **Record Playback Setup** The following selections are available ONLY when a session is NOT open.
- Then **Storage Device** to select the media which stores the sessions to be managed. This is a different setting from the Save/Recall Storage Device setting.
- Then choose from the following:
 - **Internal** FieldFox memory (default)
 - **SD Card** An external SD Card (must be inserted)
 - **USB** An external USB flash drive (must be inserted)
- Then **Manage Sessions**
- Then choose from the following:
 - **Rename** Using the FieldFox labeler, change the name of the session. AutoSession (n) is the default name where (n) is the next-available number. Learn more in **“How to use the FieldFox labeler ” on page 500.**
 - **Sort** Arrange the listing of sessions **by Name**, **by Date**, or **by Size**.
 - **Delete** After a confirmation prompt, removes the contents of the selected session from the list.
 - **Copy** Copies the selected session to a different storage device, or the same storage device with ‘Copy(n)_’ appended to the beginning of the name so that duplication is prevented.
 - **Copy All** Copies ALL of the listed sessions to a different storage device, or the same storage device with ‘Copy(n)_’ appended to the beginning of the names so that duplication is prevented.
 - **Delete All** Deletes ALL of the listed sessions.

Record Playback Example (SA Only)

The following “Interval Recording” example shows how you can record spectral activity over a longer period of time with less trace storage.

- Press **Trace 6** then, with **Trace** = 1, press **State** then **Max Hold**
- Then **Record Playback**
- Then **New Session**
- Then **Recording Configuration**
- Then **Record Source** to Trace1
- Then **Record Interval** to 10 **s** (seconds).
- Then **Back**
- Then **Recorder Player**

Interference Analyzer (SA Mode) – Option 236
Record/Playback (SA Option)

- Then **Record** At the end of each 10 second record interval, the Max Hold trace is recorded and the Max Hold processing is reset for the next 10 second record interval.
- Then **Stop** to end the recording.

This session can be played back into any Trace State. For example:

Play the Max Hold recording into a **Clear/Write trace** to see the data exactly as it was recorded.

- Press **Trace 6** then with **Trace** = 1 and press **State** then **Clr/Wr**
- Then **Record Playback**
- Then **Play**

Play the Max Hold recording into a Max Hold trace to show the accumulation of “Max Hold” activity over the entire recording.

- Press **Trace 6** then with **Trace** = 1 and press **State** then **Max Hold**
- Then **Record Player**
- Then **Play**

Interference Analyzer (SA Mode) – Option 236
Record/Playback (SA Option)

14 Reflection Mode (SA Models) - Option 320

NOTE

Option 320 requires Option 220 Tracking Generator. N9938A models require Option 100 3.5 mm connectors and Option 220.

- Option 100 3.5 mm connectors must be installed by the factory. Option 100 is only available on N9938A at the time of purchase. It is not available as a trial/upgrade.
- Option 220 Tracking Generator can be ordered via software license on www.keysight.com.

Option 320 is not available on N991xA, N992xA, or N995xA models.

This feature may require an option. Please view the FieldFox Configuration Guide at: <http://literature.cdn.keysight.com/litweb/pdf/5990-9836EN.pdf>

Reflection Mode measurements are very similar to CAT mode reflection measurements. They provide 1-port scalar reflection measurements in selected FieldFox **SA-Only** models. The FieldFox source is routed internally to Port 1 and used to stimulate a Device Under Test (DUT). The energy that is reflected off the DUT is measured and displayed on the screen.

SA mode reflection measurements are **CalReady**. Learn more in [“CalReady” on page 121](#). In addition, Normalization is available. Learn how [“Normalize” on page 290](#). However, other calibration types are NOT offered.

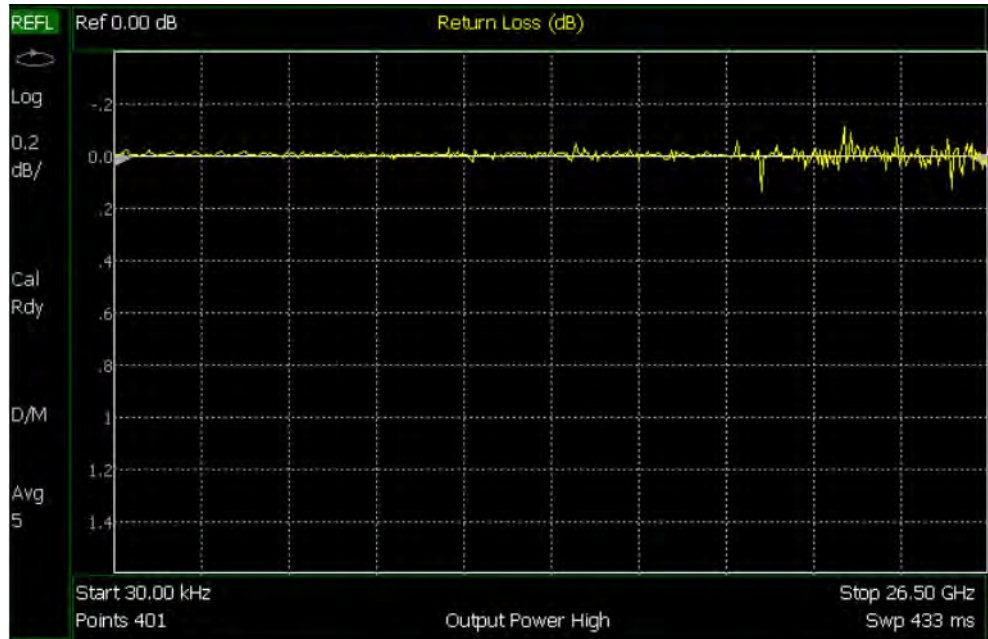

In this Chapter

[“How to select Reflection Mode” on page 290](#)

[“Measurement Selection” on page 290](#)

[“Normalize” on page 290](#)

The following settings are available exactly as they function in CAT mode:

“Frequency Range” on page 47

“Scale Settings” on page 47

“Averaging” on page 48

“Single or Continuous Measure” on page 49

“Resolution (Number of Data Points)” on page 50

“Sweep Time” on page 50

“Output Power” on page 51

“Interference Rejection” on page 51

“All about Markers” on page 438

“All about Limit Lines” on page 453

Reflection Mode Settings

Select **Reflection Mode** before making any setting in this chapter.

How to select Reflection Mode

- Press **Mode**
- Then **Reflection**

Measurement Selection

How to select a Reflection Mode Measurement

Learn more about these two measurements in the Supplemental Online Help:
<http://na.support.keysight.com/fieldfox/help/SupHelp/FieldFox.htm>

- Press **Measure 1**
- Then choose one of the following: These softkeys also appear after Reflection Mode is selected.
 - **Return Loss** 1-port scalar reflection measurement that displays the amount of incident signal energy MINUS the amount of energy that is reflected. The higher the trace is on the screen, the more energy being reflected back to the FieldFox.
 - **VSWR** (Voltage Standing Wave Ratio – also known as SWR) 1-port reflection measurement that displays the ratio of the maximum reflected voltage over the minimum reflected voltage. The higher the trace is on the screen, the more energy being reflected back to the FieldFox.

Normalize

Normalization can be used to effectively ‘Zero’ a trace, which removes frequency response errors introduced by the components of the test setup before making the measurement. To normalize a reflection measurement, the DUT is removed and a known device is connected to Port 1. When you choose Normalize, the displayed trace is stored into memory and then the displayed data is divided by the memory trace. The displayed data trace now shows the difference between the stored memory response and the measured response.

You could normalize while measuring the reflection response of any type of device. For example, the device could be:

- An Open or Short (with maximum reflection)

How to perform Normalization

To Port 1, connect a known device (usually an Open or Short) to which reflection measurements are to be normalized.

- Press **Trace 6**
- Then **Normalize**

The yellow data trace displays the current measurement with trace math applied. The math operation symbol **[D/M]** is displayed on the lower left corner of the screen. Learn more about Trace Math in [“All about Trace Math” on page 458](#).

NOTE

Data interpolation is NOT supported. If the Resolution setting is changed with Trace Math enabled, the FieldFox will disable the math operation.

Reflection Mode (SA Models) - Option 320
Reflection Mode Settings

15 Built-in Power Meter Mode – Option 310

Built-in Power Meter (also known as Channel Power Meter) uses the SA input connector to make quick and simple power measurements over a selectable frequency band. A power sensor is NOT required.

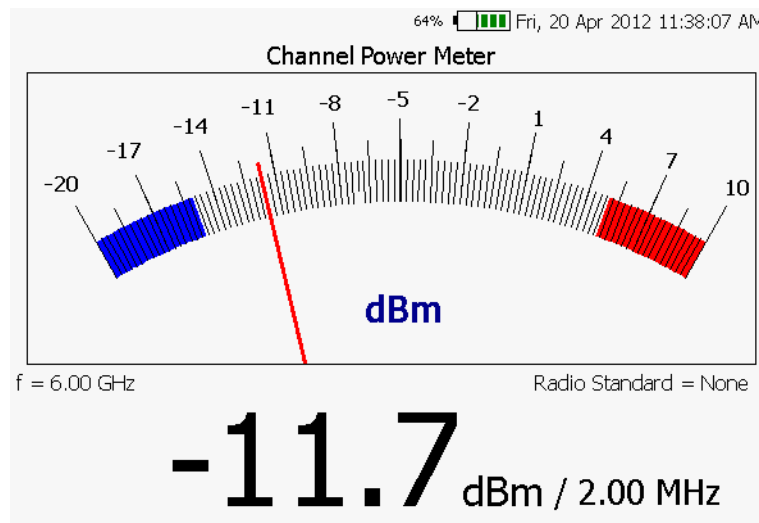

In this Chapter

[“Frequency/ Span / Step” on page 295](#)

[“Radio Standard” on page 296](#)

[“How to set Attenuation” on page 296](#)

See Also

The following Built-in Power Meter settings are identical to the standard Power Meter settings:

[“Scale” on page 303](#)

[“Relative and Offset Power Measurements” on page 304](#)

[“Display Units” on page 304](#)

[“Averaging” on page 305](#)

[“Single or Continuous Measure” on page 305](#)

[“Limits” on page 306](#)

The following Built-in Power Meter settings are identical to SA Mode settings:

[“Radio Standard” on page 296](#)

[“How to Access Individual Alignments” on page 181](#)

Built-in Power Meter Settings

Select Built-in Power Meter Mode before making any setting in this section.

How to select Built-in Power Meter Mode

- Press **Mode**
- Then **More**
- Then **Power Meter (Built-in)**

CAUTION

Please observe the SA RF Input port damage level.

+27 dBm (320 mW) average

+33 dBm peak (2 W) <10 μ s

+50 VDC

Frequency/ Span / Step

Valid Built-in Power Meter measurements can be made over the entire frequency range of the FieldFox. Although it is possible to enter a center frequency below the FieldFox minimum frequency, the LO feed-thru of the internal SA hardware will invalidate these Built-in Power Meter measurements.

The measurement span (also known as Channel Width and Integration BW) is the frequency range, half above and half below the center frequency, over which power is detected and displayed. The maximum measurement span is 100 MHz.

How to enter center frequency, step size, and span

The default frequency is 50 MHz.

- Press **Freq/Dist**
- Then **Center**
- Then type a value using the numeric keypad. Then press a multiplier key. Learn about multiplier abbreviations “**Multiplier Abbreviations**” on page 41. The current frequency (f) is shown on the FieldFox screen.
- Optionally, use the **▲▼** arrows or rotary knob to quickly change Center frequency. The size of the frequency step can also be changed. Press **CF Step** then type a step size value using the numeric keypad, then select a multiplier key.
- Optionally press **Span** Type a value using the numeric keypad. Then press a multiplier key. The default span is 20 MHz. The maximum span is 100 MHz. The current span setting is shown as the dividend in the digital display. For example: **-10 dBm / 1.00 MHz**

Radio Standard

A Radio Standard can be used to integrate power within specific radio channels. When a Radio Standard is selected, the **Span** setting is automatically coupled to the defined Channel Width for that standard. (Width is the same for all channels within a standard.) Also, **Unit** is set to **Chan**, and **CF** is set to the nearest specific Channel defined in the standard.

Learn more about Radio Standards, including Importing and Deleting Custom Radio Standards, beginning in [“Custom Radio Standards” on page 148](#)

How to select a Radio Standard

- Press **Measure 1** OR **Freq/Dist**
- Then **Radio Standard**
- Then select a standard using the **▲▼** arrows or rotary knob and press **Enter**.

Attenuation

The Attenuation setting controls the power level into the FieldFox.

To compare Built-in Power Meter Mode measurements to SA Channel Power measurements, use the same attenuation settings. Built-in Power Meter Mode defaults to 30 dB attenuation, while SA mode defaults to 10 dB attenuation. In Built-in Power Meter, the attenuation setting is NOT annotated on the screen.

How to set Attenuation

- Press **Scale/Amptd**
- Then **More**
- Then **RF Atten**
- Then use the **▲▼** arrows or rotary knob to choose from either **30 dB** or **10 dB**

NOTE

The following Built-in Power Meter settings are identical to the standard Power Meter settings. To learn about these settings, please refer to the following pages:

[“Scale” on page 303](#)

[“Relative and Offset Power Measurements” on page 304](#)

[“Display Units” on page 304](#)

[“Averaging” on page 305](#)

[“Scale” on page 303](#)

[“Limits” on page 306](#)

16 Power Meter (USB) Mode – Option 302

Power Meter measurements, available with Option 302, are made with Keysight USB power sensors. Power readings are displayed on the FieldFox screen.

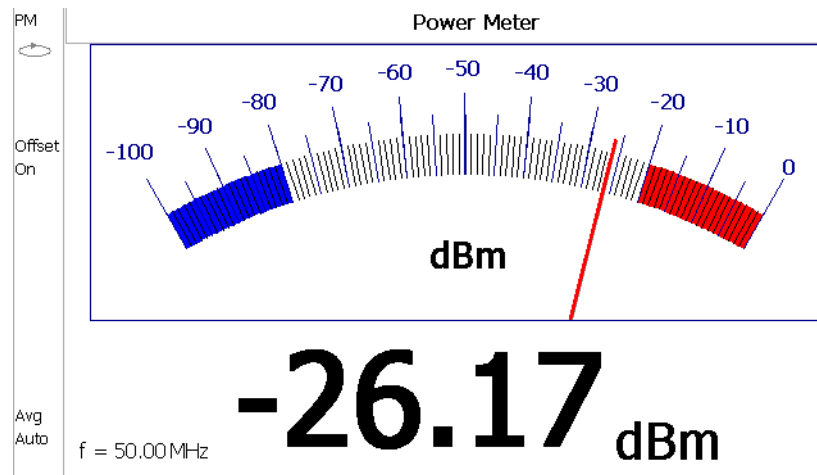

In this Chapter

- “Supported Power Sensors” on page 299
- “How to Connect the Power Sensor” on page 299
- “Average / Peak ” on page 301
- “Zeroing” on page 301
- “Frequency” on page 302
- “Source Control” on page 302
- “Relative and Offset Power Measurements” on page 304
- “Display Units” on page 304
- “Resolution” on page 304
- “Averaging” on page 305
- “Single or Continuous Measure” on page 305

Power Meter (USB) Mode - Option 302

[“Step Detection Mode” on page 306](#)

[“Limits” on page 306](#)

See Also

[“FOPS Settings” on page 311](#)

Supported Power Sensors

For a complete list of supported Keysight USB Power Sensors, please visit:
www.keysight.com/find/usbsensorsforfieldfox

NOTE

The FieldFox does NOT support the following Keysight USB Power Sensor features: External Triggering (Time Gated Burst Power Measurement), Power Sweep Operation, and Frequency Sweep Operation. External Zeroing is NOT allowed on the U2020 X-series Power Sensors.

CAUTION

Please refer to your USB Power Sensor User's Guide and observe the damage levels of your device.

How to Connect the Power Sensor

Connect your Power Sensor to one of the FieldFox USB ports.

NOTE

IMPORTANT! When a USB power sensor is initially connected to the FieldFox, it may take ~10 seconds for the USB power sensor to finish zeroing and for the FieldFox to recognize the USB power sensor. If your USB power sensor is not operating as expected:

- Verify the latest firmware is loaded on the FieldFox. Refer to www.keysight.com/find/fieldfoxsupport.
- Verify the latest firmware is loaded on the Power Sensor. Refer to <https://www.keysight.com/main/editorial>.
- Remove and re-connect the USB power sensor

NOTE

Use an attenuator between the DUT and the power sensor when measuring power levels that are higher than +20 dBm. The attenuator value can be subtracted from the measurement using the Offset feature, discussed in **“Relative and Offset Power Measurements” on page 304.**

A sequence of status lights are displayed on the base of the power sensor, when the FieldFox is in Power Meter (USB Sensor) mode.

- **Green blinking** light indicates the power sensor is communicating or self-tests are being performed. Because the FieldFox is usually communicating with the power sensor when it is connected, this is the normal mode of operation.
- **Amber light** indicates Zeroing is being performed.
- **Red light** indicates an error has occurred with the power sensor. Refer to power sensor documentation.

- **No light** indicates the FieldFox is not communicating with the power sensor. This is the case when in Hold mode or when NOT in Power Meter Mode.

USB Power Meter Settings

Select Power Meter Mode before making any setting in this section.

How to select Power Meter Mode

- Press **Mode**.
- Then **Power Meter (USB Sensor)**.

Average / Peak

- Press **Measure 1**
- Then choose from the following:
 - **Average** Measures and reports the average of the power measurements.
 - **Peak** Available ONLY on the U202x power sensors. Measures and reports peak power detected at sensor input.

Zeroing

The Keysight USB Power Sensors perform Internal Zeroing automatically. Because Keysight USB Power Sensors have an internal switch, Internal Zeroing does NOT require that the power source be turned OFF.

For highest measurement accuracy, when measuring power levels below -30 dBm, External Zeroing should be performed.

During External Zeroing, the power source MUST be turned OFF or the power sensor disconnected from the power source (device under test). Power is OFF when power sensor measurements are below -60 dBm. When power higher than this is detected at the sensor, a warning message is shown on the FieldFox and External Zeroing will not proceed.

NOTE

External Zeroing is NOT allowed on the U2020 X-series Power Sensors.

How to perform External Zeroing

- Press **Cal 5**.
- Then **External Zero**.

While either Internal or External Zeroing is being performed, “Zeroing...” is shown on the FieldFox screen. While this message is present, do NOT make any changes to the FieldFox.

In addition, once External Zeroing has started, the power source must be OFF for the entire time that the Zeroing message is present. Otherwise, the calibration will be compromised but NO warning is shown.

Frequency

A table of correction factors versus frequency is stored within Keysight Power Sensors. The frequency of the power to be measured is entered in the FieldFox so that the appropriate correction factor can be used.

The Source Control feature (see following section) will determine the frequency range of the power measurement.

How to enter Frequency of the Power Measurement

- Press **Freq/Dist** or **Meas Setup 4**.
- Then **Frequency**.
- Then type a value using the numeric keypad. The default frequency is 50 MHz.
- Then press a multiplier key. Learn about multiplier abbreviations in **“Multiplier Abbreviations” on page 41**.

The current frequency is shown on the FieldFox screen.

Source Control

This feature may require an option on some FieldFox models.

With the FieldFox internal source enabled, these settings allow you to make simple, absolute power measurements. The source and the power sensor can be physically separated by a long distance when using a long USB cable.

Set the internal source frequency by setting the frequency of the power measurement. Learn how in the previous section.

Power Meter measurements are limited by the combined frequency ranges of the internal source when enabled and the frequency range of the power sensor. For example, assume the frequency range of your sensor is 9 kHz to 18 GHz and the frequency range of the FieldFox is 2 MHz to 6 GHz.

- With the Source ON, measurements are limited to 2 MHz to 6 GHz.
- With the Source OFF, measurements are allowed from 9 kHz to 18 GHz.

How to Set Source Control and Power Level

- Press **Freq/Dist**

- Then **Advanced**

NOTE

When Option 208 (FOPS) is enabled, to access Source Control, press Sweep 3, then **Power Setup**. Learn more about FOPS beginning on page Chapter 17, “Frequency Offset Using Power Sensor (FOPS) – Option 208”, on page 307.

- Then **Source Enable**
 - **ON** Turn ON the internal source
 - **OFF** Turn OFF the internal source

Optionally set the power level.

- Press **Src Nom Power** (-15 dBm default setting) Set output power to an arbitrary value at the displayed CW frequency.
- Then enter a value using the numeric keypad, the **▲▼** arrows, or the rotary knob.
- Press **Enter**

Scale

The scale of the Power Meter display can be set manually or automatically. The major and minor ticks are set automatically and can NOT be changed. Although the scale settings are limited, you can view measurements beyond these settings by performing Autoscale.

How to Scale the Power Meter Display

Manually:

- Press **Scale / Amptd**.
- Then choose from the following:
 - **Scale Min** Sets the low power level of the power meter display. Type a number and select the units or press Enter. This value is limited to – 100 dBm.
 - **Scale Max** Sets the high power level of the power meter display. Type a number and select the units or press Enter. This value is limited to 100 dBm.

Autoscale:

Using Autoscale, the current reading is used for the center of the scale, and Min and Max values are set accordingly.

- Press **Scale / Amptd**.
- Then **More**.
- Then **Autoscale**.

Relative and Offset Power Measurements

Power measurements can be made that are relative to another reading or that are offset by a fixed value.

- Use Relative to measure the difference between power levels.
- Use Offset to account for components or a long length of cable that is used before the power sensor. For example, if using a 10 dB attenuator to protect the FieldFox, enter an Offset Value of 10 to read the power as it would appear without attenuation. If using a 10 dB amplifier, enter an Offset Value of -10 to read the power as it would appear without amplification.

How to set Relative and Offset Power Measurements

- Press **Scale / Amptd**.
- Then choose from the following:
 - **Relative Off On** When switched to ON, the FieldFox measures and stores the current power level. Subsequent power measurements display a power level which is relative to the stored value. When relative is ON, the units change from dBm to dB or from Watts to %.
 - **Offset Off On** Toggles ON and OFF the displayed power level using the Offset value.
 - **Offset Val** Value by which the power meter display is offset. A positive value compensates for a component with loss. A negative value compensates for a component with gain. Offset values are limited to +/- 100 dB.

Display Units

Select whether to display power in dBm or Watts. When making relative power measurements, these change to dB and %.

How to set Power Meter display units

- Press **Meas Setup 4** or **Scale / Amptd**, **More**
- Then **Unit**.
- Then choose from the following:
 - **dBm (dB)** Sets Power Meter display to dBm or dB.
 - **Watt (%)** Sets Power Meter display to Watts or %.

Resolution

Resolution sets the number of digits to display after the decimal point on the digital power meter display.

How to set Resolution

- Press **Scale / Amptd**.
- Then **More**.
- Then, in **Resolution**, choose from 0, 1, 2, or 3.

Averaging

Averaging is used to improve measurement accuracy in low power or noisy power situations. Increased averaging improves measurement accuracy, but also reduces measurement speed.

How to set Power Meter Averaging

- Press **BW 2** or **Meas Setup 4**.
- Then choose from the following:
 - **Averaging Auto Man Off**
 - **Auto** Allows the USB Power Sensor to use its Auto Averaging settings. See the USB Power Sensor documentation for details.
 - **Man** Manually enter an averaging count by setting **Num Averages**.
 - **OFF** Performs NO averaging.
 - **Num Averages** Sets the number of Power Meter readings to be averaged before a valid reading is displayed. When the number is changed, **Averaging** is automatically set to Man.

Single or Continuous Measure

This setting determines whether the FieldFox measures continuously or only once each time the **Single** button is pressed. Use **Single** to conserve battery power or to allow you to save or analyze a specific measurement.

This setting can be changed at any time without affecting calibration accuracy.

How to set Single or Continuous

- Press **Sweep 3**.
- Then choose one of the following:
 - **Single** Automatically sets Continuous OFF and causes FieldFox to make ONE measurement, then hold for the next **Single** key press. When a data trace is displayed, the entire trace is measured, then holds. The **Hold** annotation changes to an arrow --> while the measurement occurs.
 - **Continuous OFF ON** Makes continuous measurements. This is the typical setting when battery power is not critical.

You can also use **Run / Hold +/-** to toggle between Single and Continuous.

Step Detection Mode

The FieldFox supports the Step Detection feature that is present in Keysight USB power sensors. When enabled, this feature reduces settling time after a significant step in the measured power. For more information, please refer to the USB Power Meter documentation.

How to set Step Detection mode

- Press **Meas Setup 4**.
- Then **Step Detection OFF ON**
- Then choose from the following:
 - **ON** Enables step detection (default setting)
 - **OFF** Disables step detection

Limits

In Power Meter Mode, Minimum and Maximum limits set a visible range of acceptable readings between these two values. Readings that are below the minimum or above the maximum are clearly visible on the power meter display.

How to set Limits

- Press **Limit 8**.
- Then choose from the following:
 - **Min Limit OFF ON** Toggles the display of the Minimum limit ON and OFF.
 - **Min Limit Value** Sets the Minimum limit power value. Power reading lower than this will exceed the limit.
 - **Max Limit OFF ON** Toggles the display of the Maximum limit ON and OFF.
 - **Max Limit Value** Sets the Maximum limit power value. Power reading higher than this will exceed the limit.

17 Frequency Offset Using Power Sensor (FOPS) – Option 208

FOPS is accessed through (and requires) Option 302 USB Power Meter Mode. With both options installed, you can send a signal with the FieldFox internal source at one frequency, and measure this signal with a Keysight U-Series USB Power Sensor at another frequency.

Figure 17-1 Display for FOPS

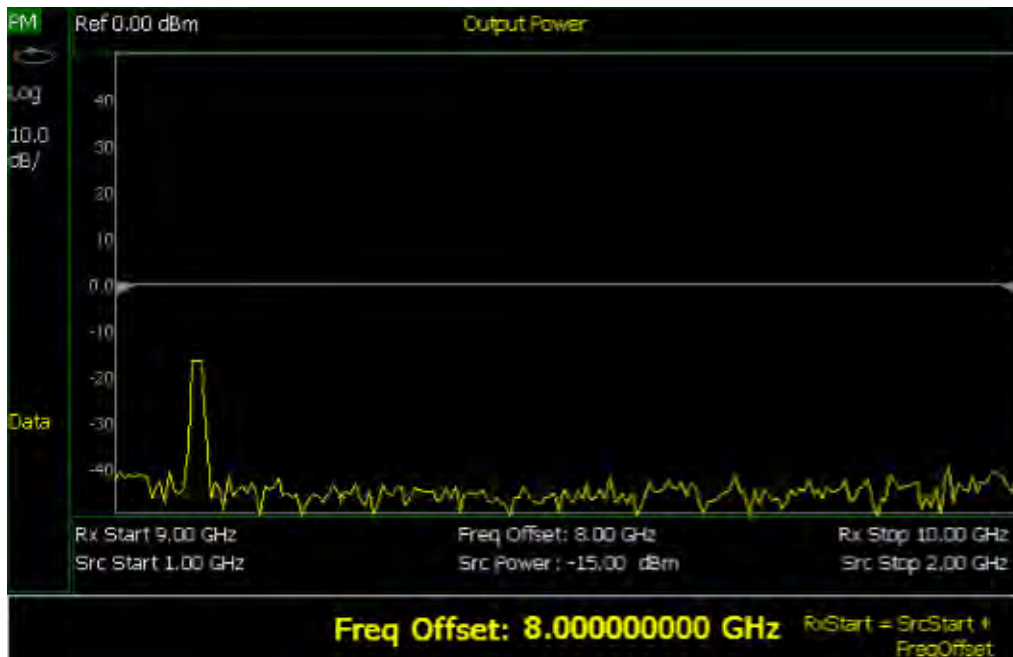

In this Chapter

[“How to select Power Meter \(USB Sensor\)” on page 311](#)

[“Measurement Selection” on page 311](#)

[“Sweep Type and Frequency” on page 312](#)

[“Power Sensor Settling” on page 314](#)

[“Sweep Settings” on page 314](#)

[“Amplitude Markers” on page 315](#)

[“Trace Math” on page 315](#)

See Also

[“All about Trace Math” on page 458](#)

Overview

This feature allows the FieldFox source frequency to be set independently from the power sensor (receiver) frequency. With frequency offset using power sensor (FOPS), the frequency of both the source and receiver are swept, and the two track each other. The offset frequency can be negative, zero, or positive.

FOPS can be used to characterize the scalar transmission response of devices such as mixers and converters. This frequency offset capability is necessary for conversion loss/gain measurements on frequency-translating devices since, by definition, the input and output frequencies of the DUT are different. The FieldFox source stimulates the DUT and the power sensor is used as the measurement receiver.

Since power sensors are inherently broadband devices (not frequency-selective), it is your responsibility to ensure that ONLY the signal of interest is present at the power sensor input and that all other signals are filtered appropriately.

For some DUTs, the output frequency may sweep in a reverse direction, as compared to the source frequency. The FieldFox analyzer includes an offset calculator that ensures a fast measurement setup.

The following shows a typical use case for FOPS:

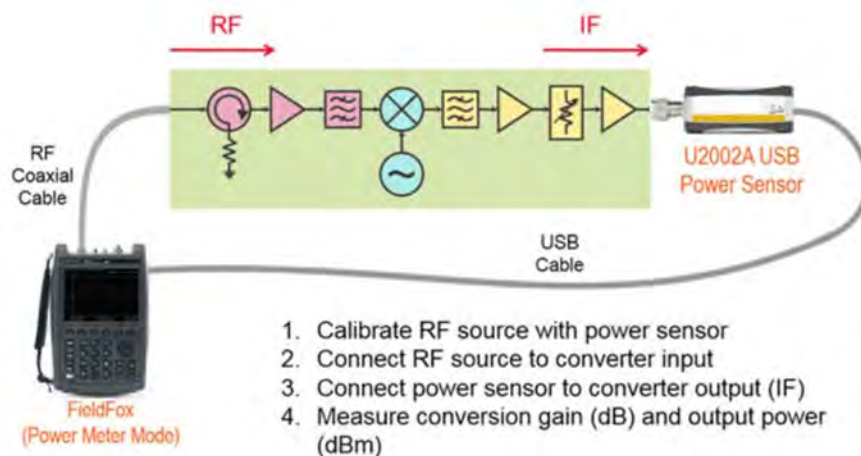

- The DUT is a long section of cable and a frequency converter.
- The FieldFox source is tuned to the RF frequency.
- The USB power sensor, with an equally long USB/LAN cable, is connected to the IF Output. USB/LAN extenders are NOT provided with the FieldFox or Keysight USB power sensors.
- Conversion gain/loss is measured at power sensor.

NOTE

The dynamic range with FOPS may be significantly different when using various power sensors. In general, the lower frequency range sensors have better dynamic range.

FOPS Settings

The following settings are unique to FOPS. Standard USB Power Meter mode settings, which may be useful with FOPS, are documented in that chapter starting in **“USB Power Meter Settings” on page 301**

Select Power Meter (USB Sensor) before making any setting in this section.

How to select Power Meter (USB Sensor)

- Press **Mode**
- Then **Power Meter (USB Sensor)**
- Then connect a USB Power Sensor to either FieldFox USB port.
- For a complete list of supported Keysight USB Power Sensors, please visit: www.keysight.com/find/usbsensorsforfieldfox

Measurement Selection

- Press **Measure 1**
- Then choose from the following:
 - **Src Power Measure** Similar to a ‘normalization’ cal, this selection guides you through the following steps to make a measurement at the reference plane and then store the data trace into memory.
 - Connect the power sensor to the measurement reference plane. This is the location to where power measurements are to be referenced. For example, to measure only the conversion loss through a converter, attach the power sensor to the cable that connects to the converter input.
 - Press **Measure**. When finished, press **Src Data -> Mem** to store the measured data into FieldFox memory. Preset or Mode Preset will clear the stored memory.
 - 3. Optionally choose from the following:
 - **Re-Measure** Make another measurement
 - **Src Data** View only the re-measured data.
 - **Src Memory** View only the stored memory data.
 - **Src Data & Memory** View both the re-measured data and the stored memory data.
 - 4. Press **Done**
 - **Src Power Memory** Not available until source data is stored into memory. Displays only the source power memory trace.

- **Gain** Not available until source data is stored into memory. Displays the Output power / Source power (memory trace).
- **Rx Power** Displays the raw received power at the USB power sensor.

Sweep Type and Frequency

Set the source and receiver frequencies for the FOPS measurements. The receiver is a Keysight U-Series Power Sensor. These are broadband measurement devices, which means that they measure power over a very wide frequency range. Tables of frequency and power correction factors are stored within the power sensors. The receiver (Rx) frequencies are used ONLY to apply the appropriate correction factors to the power levels measured with the power sensor.

NOTE

It is YOUR responsibility to ensure that ONLY the signal of interest is present at the power sensor. All other signals MUST be filtered appropriately.

How to set Sweep Type and Frequency

- Press **Freq/Dist**
- Then **Sweep Type**
- Then choose from the following:
 - **CW** Used to make standard (non-offset) power meter measurements at a single frequency. Learn more in “**USB Power Meter Settings**” on page 301.

NOTE

To make FOPS measurements at a single frequency, choose Swept, then enter a Src Center frequency, then Span = 0 Hz.

- **Swept** Used to make swept FOPS measurements.
 - Then enter source (Src) frequencies as either Center and Span or Start and Stop. Both methods set the FieldFox internal source sweep range out the Port 1 RF Output connector.
 - The frequency limits are determined by the limits of both the FieldFox and the power sensor.
 - The LOW frequency is limited by the higher of either the FieldFox or the power sensor minimum frequencies.
 - The HIGH frequency is limited by the lower of either the FieldFox or the power sensor maximum frequencies.
 - Then **More**.
 - Then **Freq Display**. This determines how the receiver frequencies below the gratitudes are displayed. Choose from the following:

- **Start** Annotated as Start and Stop frequencies.
- **Center** Annotated as Center and Span frequencies.
- Then choose from the following two methods to determine the **offset frequency** (the frequency that the receiver is offset from the source). This is typically the frequency of the LO that is used with the frequency converter. The frequency offset may be positive, negative, or zero.
- **Freq Offset** Enter an Offset frequency. The receiver frequencies are calculated.
- **Offset Calculator** Enter the Receiver Start and Stop frequencies. Then press **Calculate Offset**.
- Press **Rx Sweep** to select the receiver sweep direction.
 - **Fwd** Used for systems for which the output frequency is $\text{Offs} + \text{Src}$. The output frequency of the DUT and the receiver sweeps in the same direction as the source.
 - **Rev** Used for systems for which the output frequency is $\text{Offs} - \text{Src}$. The output frequency of the DUT and the receiver sweeps in reverse direction as compared to the source.

Invalid Settings

Violations of the following conditions will return an error message:

- The frequency span for the source and receiver must be the same.
- Both the source and receiver frequencies must be positive.

FOPS Configuration Examples

Negative Offset, RxSwp = **Fwd** ($\text{Offs} + \text{Src}$)

Src = 2 GHz to 3 GHz

Offset = -1 GHz

Rx = 1 GHz to 2 GHz

Positive Offset, RxSwp = **Rev** ($\text{Offs} - \text{Src}$)

Src = 2 GHz to 3 GHz

Offset = 3.8 GHz

Rx = 1.800 GHz to 800 MHz

Positive Offset, RxSwp = **Fwd** ($\text{Offs} + \text{Src}$)

Src = 2 GHz to 3 GHz

Offset = 3.8 GHz

Rx = 5.8 GHz to 6.8 GHz

Power Sensor Settling

The following two settings work together to allow you to choose the right compromise between measurement speed and accuracy.

Each power sensor reading is considered “settled” when either:

- The difference between two consecutive readings are within the Tolerance value.
- **Or** the Max (number of) Readings has been made.

The readings that were taken are averaged together to become the displayed reading.

How to choose Power Sensor settling

- Press **BW 2**
- Then **Tolerance**. Enter a value in dB between 0 and 10 using the numeric keypad, the **▲▼** arrows, or the rotary knob. Tolerance of 0 will never be achieved, so the Max Readings will always be made. Press **Enter**
- Then **Max Readings**. Enter a value between 1 and 20 using the numeric keypad, the **▲▼** arrows, or the rotary knob. Press **Enter**

Sweep Settings

These settings provide added control of the FOPS measurement.

How to make additional sweep settings

- Press **Sweep 3**
- Then choose from the following:
 - **Power Setup**
 - **Source Enable**
 - **ON** Turn ON the internal source (required for FOPS).
 - **OFF** Turn OFF the internal source
 - **Src Nom Power** (-15 dBm default setting) Set output power to an arbitrary value at the source CW frequency. Then enter a value using the numeric keypad, the **▲▼** arrows, or the rotary knob. Press **Enter**
 - **Num Points** or **Freq Step Size** Both settings control the number of power sensor measurements between the Start and Stop frequencies. Enter one setting and the other will be changed automatically. There must be at least two data points.

- **Dwell /Point** Specifies a settling time (in seconds) after the internal source steps to the next frequency and before the power sensor makes a measurement.

Amplitude Markers

Amplitude markers are horizontal dotted lines that you can move to any amplitude level on the screen. The two amplitude markers can be set independently or used as a pair of delta markers. Amplitude markers can be used as a visual comparison aid with the data trace.

How to make Amplitude Marker settings

- Press **Marker**
- Then **More**
- Then **Ampl Markers**
- Then choose from the following:
 - **OFF** Amplitude markers are NOT displayed.
 - **ON** Amplitude markers ARE displayed at their previous positions.
- Then **Ampl Mkr 1 or 2**
- Enter a value in dBm for the marker using the numeric keypad, the **▲▼** arrows, or the rotary knob.
- Press **Delta Ampl Mkr**
- Then choose from the following:
 - **ON** AmplMkr 2 value is relative to AmplMkr 1. When AmplMkr 1 is moved, AmplMkr 2 also moves to maintain the AmplMkr 2 value between them.
 - **OFF** The two amplitude markers move independent of one another.

Trace Math

Trace Math allows you to compare data traces and perform simple math. Learn how to use Trace Math in [“All about Trace Math” on page 458](#). All Data and Memory features work as documented EXCEPT for the following:

NOTE

When Trace, then Data -> Mem is pressed, if a Src Power trace is active, then RxPower is actually stored into memory.

To Compare Src Power (Input) and Rx Power (Output):

1. Meas Rx Power
2. Store to memory
3. View Data & Memory
4. Meas Src Power.

Frequency Offset Using Power Sensor (FOPS) – Option 208
FOPS Settings

18 Pulse Measurements Mode – Option 330

Pulsed power meter measurements, available with Option 330, are made with Keysight U2020 X-Series USB Peak Power Sensors. These sensors are capable of detecting, measuring, and storing data from a train of pulses at the RF input. This data is queried from the USB Power Sensor and displayed on the FieldFox screen. You can then analyze the data using several selectable settings.

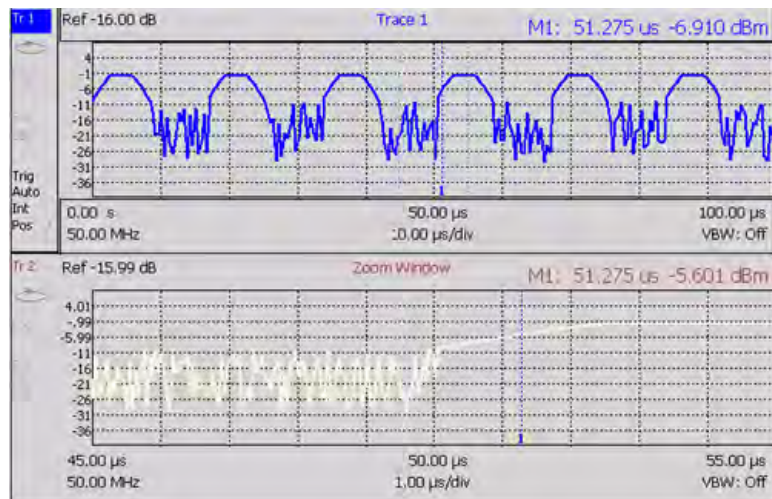

In this Chapter

- “Supported Power Sensors” on page 319
- “Measurement Selection” on page 320
- “Frequency / Time” on page 320
- “Zoom Window” on page 321
- “Scale” on page 322
- “Averaging ” on page 322
- “Video Bandwidth” on page 323
- “Single or Continuous Measure” on page 323
- “Resolution” on page 324

“Triggering” on page 324

“Marker Settings” on page 327

“Amplitude Markers” on page 328

“How to Search with Markers” on page 328

“How to enable Auto Analysis” on page 330

“Pulse Top” on page 330

“Grid” on page 330

“Trace Memory” on page 330

NOTE

Many of the features included with the FieldFox Pulse Measurements Mode are discussed in detail in these two documents:

-
- Keysight U2020 X-Series USB Peak Power Sensors Programmer's Guide.
<http://literature.cdn.keysight.com/litweb/pdf/U2021-90003.pdf>
 - “Best Practices For Making The Most Accurate Radar Pulse Measurements”
<http://literature.cdn.keysight.com/litweb/pdf/5991-0434EN.pdf>

Supported Power Sensors

Pulse measurements are made using any of the Keysight U2020 X-Series USB Peak Power Sensors.

Zeroing of the U2020 X-Series USB Peak Power Sensors is performed automatically at power up, every 5 seconds, and prior to measuring low level signals.

Switching between Pulse Measurement Mode and Power Meter Mode

NOT Supported - Using a single USB Peak Power Sensor and switching between Power Meter Mode and Pulse Measurement Mode. Both modes will attempt to program the sensor, which could cause one or both modes to hang, or at least report inaccurate data.

Supported - Using one U2000A Average Power Sensor connected to the top USB port for Power Meter Mode, and one Peak Power Sensor connected to the bottom USB port for Pulse Measurement Mode.

How to Connect the Power Sensor

Connect your Power Sensor to one of the FieldFox USB ports.

NOTE

Use an attenuator between the DUT and the power sensor when measuring power levels that are higher than +20 dBm. The attenuator value can be subtracted from the measurement using the Offset feature, discussed in [“Relative and Offset Power Measurements” on page 304](#).

A sequence of status lights are displayed on the base of the power sensor.

- **Green blinking** light indicates the power sensor is communicating or self-tests are being performed. Because the FieldFox is usually communicating with the power sensor when it is connected, this is the normal mode of operation.
- **Amber light** indicates Zeroing is being performed.
- **Red light** indicates an error has occurred with the power sensor. Refer to power sensor documentation.
- **No light** indicates the FieldFox is not communicating with the power sensor. This is the case when in Hold mode or when NOT in Pulsed Measurement Mode.

Pulse Measurement Settings

Select Pulse Measurement Mode before making any setting in this section.

How to select Pulse Measurement Mode

- Press **Mode**
- Then **More** if your FieldFox contains more than five measurement modes.
- Then **Pulse Measurements**

Measurement Selection

The pulse measurement results are presented as either a traditional power meter display or as a trace graph.

How to select the Measurement

- Press **Measure 1**
- Then choose from the following:
 - **Average** Average power (Meter display)
 - **Peak** Peak power (Meter display)
 - **Pk to Avg** Displays the difference between the above two measurements (Meter display)
 - **Trace Graph** (default) The primary trace (Tr 1) plots pulse data in amplitude versus time. Optionally, you can enable a secondary ‘zoom’ trace. Learn how in [“Zoom Window” on page 321](#).
 - When a ‘Meter display’ measurement is selected, the following Pulse Measurement Mode settings are identical to the standard USB Power Meter Mode settings.
 - Learn how to set Scale in [“Scale” on page 322](#).
 - Learn how to set **Relative and Offset Power** in [“Relative and Offset Power Measurements” on page 304](#).
 - Learn how to set **Display Units** in [“Display Units” on page 304](#).
 - Learn how to set **Limits** in [“Limits” on page 306](#).

Frequency / Time

How to set Frequency

- Press **Freq/Dist**
- Then choose from the following:

- **Frequency** Sets the center frequency of the carrier on which pulse modulation resides. This is used to set amplitude correction of the USB Power Sensor.

How to set Time

Specify the time over which data will be acquired by the USB Power Sensor. When Trace Graph is selected, **Tr 1** is annotated with these values. Time can be specified using either of the following pairs of values:

- **Center 1** and **Time/div 1** Specify the center time and time per division.
- **Start Time** and **Time Length** Specify the start time and length of acquisition.
- A positive start time indicates a delay after the sensor detects a pulse signal.
- A negative start time displays data that is acquired BEFORE the sensor detects a pulse signal (or T-zero).
- Follow each by entering a value using the numeric keypad, the **▲▼** arrows, or the rotary knob.
- After using the keypad, select a multiplier key. Learn about multiplier abbreviations.

Zoom Window

When Trace Graph is selected as the measurement, a secondary Zoom Trace can be used to view a zoomed portion of **Tr 1**. When Zoom Window is ON, blue vertical posts appear on **Tr 1** to indicate the current start, center, and stop times of the zoom window. The zoom window can be scaled using the standard Scale settings.

How to make Zoom Window settings

- Press **Measure**
- Then **Trace Graph**
- Press **Trace 6**
- Then **Zoom Window OFF ON**
- Then choose from the following:
 - **ON** Opens the zoom window on the bottom half of the FieldFox screen. The window includes the zoomed trace.
 - **OFF** Closes the zoom window.
- **Zoom Center** While monitoring the T within the blue vertical posts on **Tr 1**, enter a value for the center time using the numeric keypad, the **▲▼** arrows, or the rotary knob.

- **Zoom Time/div** While monitoring the blue vertical posts on the primary trace, enter a value for the zoom window span using the numeric keypad, the \uparrow/\downarrow arrows, or the rotary knob.
- **Trace 1** Press to select **Tr 1**. This can also be done by using the \uparrow/\downarrow arrows. Select a trace before making trace settings, such as Scale.
- **Zoom Trace** Press to select the zoom trace.

Scale

For Meter-style measurements, learn how to set Scale, Relative and Offset Power, display Units, and Resolution beginning in [“Scale” on page 322](#).

How to set Scale for Trace Graph measurements

- Select a trace to scale using the \uparrow/\downarrow arrows.
- Press **Scale / Amptd**
- Then choose from the following methods:
 - **Autoscale** Automatically adjusts the Y-axis to comfortably fit the Minimum and Maximum amplitude of the trace on the screen.
 - Set Scale, acquisition, and Reference Position:
 - **Scale** Manually enter a **scale per division** to view specific areas of the trace.
 - **Ref Level** Manually set the value of the reference line. Enter a negative value by pressing **Run/Hold (+/-)** either before or after typing a value.
 - **Ref Pos** Manually set the position of the reference line. Values must be between 0 (TOP line) and 10 (BOTTOM line).
 - **Offset ON** Enable Offset. When only trace 1 is visible, **Offset ON** appears to the left of the trace.
 - **Offset Val** Enter a value by which all amplitude values will be offset. This can have the effect of virtually removing a component from the measurement path. A positive value compensates for a component with loss. A negative value compensates for a component with gain. Offset values are limited to +/- 100 dB.

Averaging

Averaging helps to reduce the effects of random noise on a measurement. The more measurements that are averaged, the greater the amount of noise reduction. Averaging is allowed for all pulse measurements.

Averaging is performed in the USB Power Sensor before the data is sent to the FieldFox.

Annotation in the left pane shows the state of the Average setting. When Manual is selected, the 'Num of Averages' setting is also shown.

How to set Averaging

- Press **BW 2**.
- Then **Averaging**
- Then choose from the following:
 - **Auto** Averaging is set to a reasonable value by the USB Power Sensor.
 - **Man** Averaging is set to the value specified in the 'Num Averages' setting.
 - **Off** Averaging is OFF
- **Num Averages** Select a value using the numeric keypad, then press **Enter**.

Video Bandwidth

The Video Bandwidth setting enables an FIR (finite impulse response) filter within the USB Power Sensor. The filter setting affects the appearance of the trace results.

Video Bandwidth is allowed for all pulse measurements

How to set Video Bandwidth

- Press **BW 2**.
- Then **Video Bandwidth**
- Then choose from the following:
 - **Off** Video Bandwidth is disabled.
 - **Low** Similar to a low pass filter, ripple in the pass band is minimized but allows higher side-lobes on the filter skirt.
 - **Medium** Smooth pass band with reasonable transition ripple.
 - **High** The pass band ripple is similar to the OFF setting, but the transition skirts are smoother.

Single or Continuous Measure

This setting determines whether the FieldFox continuously queries the USB Power Sensor for data, or only once each time the **Single** button is pressed. Use **Single** to conserve battery power or to allow you to save or analyze specific data.

How to set Single or Continuous

- Press **Sweep 3**
- Then choose one of the following:
 - **Single** Automatically sets Continuous OFF and causes the FieldFox to query the USB Power Sensor ONCE, then hold for the next Single key press. Hold is annotated in the upper left corner of the display.
 - **Continuous OFF ON** Queries the USB Power Sensor whenever a valid trigger signal is present. This is the typical setting when battery power is not critical.

You can also use **Run / Hold +/-** to toggle between Single and Continuous.

Resolution

Resolution is the number of individual acquisitions that occur in the USB Power Sensor. This data is read by the FieldFox and plotted across the X-axis to form a trace. More data points increases measurement resolution. However, more data points requires more time to acquire, query, and plot.

How to set Resolution

- Press **Sweep 3**
- Then **Resolution**
- Then choose from the following:
 - **Low** 240 data points.
 - **Medium** 1000 data points.
 - **High** Calculated value - approximately 8000 data points.

Triggering

For pulse measurements, a trigger signal refers to the event that causes the USB Peak Power Sensor to initiate measurement acquisition. It does NOT refer to triggering the FieldFox.

Trigger settings can be used with ALL pulse measurements unless stated otherwise.

A **Waiting for Trigger** message on the FieldFox screen is posted on behalf of the USB Power Sensor when it is waiting for a pulse signal at the RF Input (Internal) or a TTL signal at the USB Sensor External Trigger input.

How to make Trigger settings

- Press **Sweep 3**
- Then **Trigger**

- Then **Trig Type**
- Then choose from the following:
 - **Freerun** The USB Power Sensor acquires data without waiting for a trigger. This mode is NOT supported for Trace Graph measurements.
 - **Internal** The USB Power Sensor acquires data when a valid pulse signal is detected at the RF input. The following Trigger settings determine the validity of the trigger signal.
 - **External** The USB Power Sensor acquires data when a valid TTL signal is detected at the USB Power Sensor external trigger input.

Trigger Edge

This setting determines which edge of a trigger signal initiates data acquisition.

- Press **Sweep 3**
- Then **Trigger**
- Then **Trigger Edge**
- Then choose from the following:
 - **Pos** Acquisition is triggered by the rising (positive) edge of a valid signal.
 - **Neg** Acquisition is triggered by the falling (negative) edge of a valid signal.

Trigger Delay

After a valid trigger signal is received at the USB Power Sensor, data acquisition begins after the specified Trigger Delay time PLUS the specified Start time. See the Pulse Timing diagram in **“Trigger Settings Annotation” on page 327** for more information.

- Press **Sweep 3**
- Then **Trigger**
- Then **Trigger Delay**
- Then enter a value using the numeric keypad, the **▲▼** arrows, or the rotary knob.

Auto Trigger

Used ONLY when Trigger Type = Internal, this setting determines whether the trigger level is set manually or is set to the default level in the USB Power Sensor firmware.

- Press **Sweep 3**
- Then **Trigger**

- Then **Auto Trigger**
- Then choose from the following:
 - **ON** Trigger level is determined by the USB Power Sensor firmware.
 - **OFF** The trigger level is set manually using the Trigger Level setting.

Trigger Level

Used when Trigger Type = Internal AND Auto Trigger = OFF (Manual).

- Press **Sweep 3**
- Then **Trigger**
- Then **Trig Level**
- Then set the trigger level using the numeric keypad, the **▲▼** arrows, or the rotary knob. A line appears on **Tr 1** at the current trigger level setting. Data acquisition occurs when the RF input signal crosses the line. This setting can be used with either Positive or Negative edge triggering.

Qualification

Use the qualification setting to avoid triggering on false pulses and to aid in stabilizing the power trace.

The qualification time defines the time the signal has to remain below the trigger threshold before a transition through the threshold will qualify as a trigger. This can help stabilize a power trace, particularly with digitally modulated pulses that may have many transitions through the trigger threshold. By setting the qualification time longer than the short transitions of the data signal the sensor will reliably trigger on the pulse and not on the data. It will also eliminate triggering on very short noise spikes when the trigger level has to be set to low power.

NOTE

It may be necessary to set the qualification time to the minimum 20 ns in order to trigger on very short pulses.

-
- Press **Sweep 3**
 - Then **Trigger**
 - Then **Qualification**
 - Then set the qualification value using the numeric keypad or the rotary knob (default: 100 ns, minimum: 25 ns, maximum: 50 μ s).

Trigger Settings Annotation

Trigger settings are annotated on the FieldFox screen as highlighted in **red** in the following image:

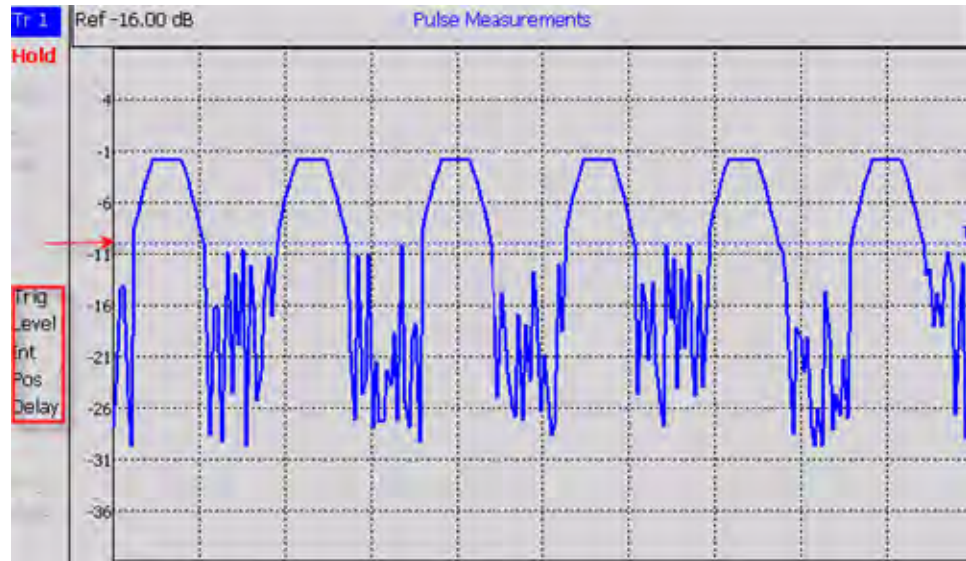

In the previous graphic, the settings are: Trig Level = -10 dBm, Trig Type (Int), Pos Slope (/), Delay

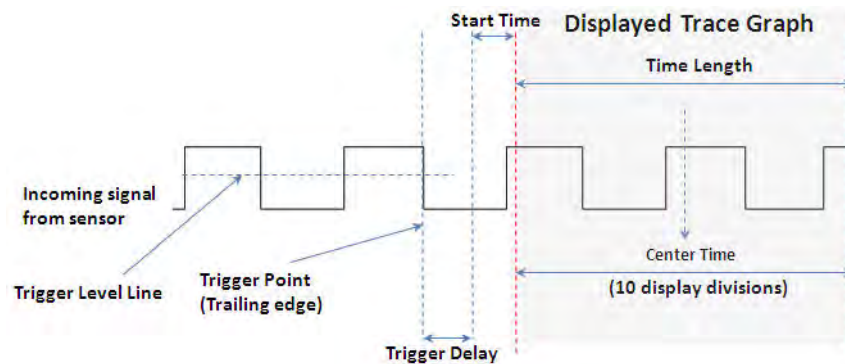

Marker Settings

Markers are not allowed with Meter-style measurements.

Markers are displayed on **Tr 1** and also on the zoom trace if the marker is within the zoom window time span.

Up to six standard markers can be used to provide readouts of the Y-axis amplitude at the current X-axis location.

The six standard markers can also be used as Delta Markers.

Learn more about standard markers in [“All about Markers” on page 438](#).

Amplitude Markers

Amplitude markers are horizontal dotted lines that you can move to any amplitude level on the screen. The two amplitude markers can be set independently or used as a pair of delta markers.

Amplitude markers can be used as a visual comparison aid with the pulse measurement traces.

How to make Amplitude Marker settings

- Press **Marker**
- Then **More**
- Then **Ampl Markers**
- Then choose from the following:
 - **OFF** Amplitude markers are NOT displayed.
 - **ON** Amplitude markers ARE displayed at their previous positions.
- Then **Ampl Mkr 1 or 2**
- Enter a value in dBm for the marker using the numeric keypad, the **▲▼** arrows, or the rotary knob.
- Press **Delta Ampl Mkr**
- Then choose from the following:
 - **ON** AmplMkr 2 value is relative to AmplMkr 1. When AmplMkr 1 is moved, AmplMkr 2 also moves to maintain the AmplMkr 2 value between them.
 - **OFF** The two amplitude markers move independent of one another.

Marker Search

Use Marker Search to find and move markers to locations on the **Tr 1** trace.

How to Search with Markers

- Activate the marker to be used for the search
- Then press **Mkr ->/Tools**.
- Then **Marker Search**
- Then **Zone Search**
- Then choose from the following:
 - **ON** Available ONLY when the zoom window is enabled, the search is limited to the zone defined by the zoom window.
 - **OFF** The search is performed over the entire Tr 1 trace.

Then choose from the following:

- **Target, Peak, and Minimum.** Learn more about these standard features beginning in **“Searching with Markers” on page 444.**
- **Rise Time** Select, then set a value in dB. Delta markers are created and placed at the Peak and at the specified value BEFORE the Peak.
- **Fall Time** Select, then set a value in dB. Delta markers are created and placed at the Peak and at the specified value AFTER the Peak.

NOTE

Rise and Fall time in Marker Search uses different criteria than in Auto Analysis and will therefore result in different reported values.

Auto Analysis

Auto Analysis reports the following TEN pulse measurements:



1 - Average Power	Average power level of all measured data points
2 - Peak Power	Highest reading of all measured data points
3 - Peak minus Average	Difference between the above two results
4 - Pulse Top	Power value based on the specified Pulse Top setting.
5 - Rise Time	The time it takes for a pulse to rise from 10% to 90% of its peak value.
6 - Fall Time	The time it takes for a pulse to fall from 90% to 10% of its peak value.
7 - Pulse Width	The time between the rising edge and falling edge of a pulse.
8 - Pulse Period	The time of one complete pulse cycle
9 - Duty Cycle	The ratio of the pulse width / pulse period.
10 - Pulse Rep Freq	The rate, in pulses / sec, at which pulses recur.

How to enable Auto Analysis

- Press **Mkr ->/Tools**.
- Then **Auto Analysis**
- Then choose from the following:
 - **OFF** Analysis OFF
 - **ON** The Analysis values appear below trace 1.

Pulse Top

Pulse Top is NOT the same as the pulse Peak. Pulse Top is used to set and report the reference power level. You enter a value in percent, and the Pulse Top value is reported in the Auto Analysis table in dB down from 100% of the reference power level.

How to set Pulse Top

- Press **Mkr ->/Tools**
- Then **Pulse Top**
- Then enter a percent value between 0 and 100 using the numeric keypad, the **▲▼** arrows, or the rotary knob.
 - When set to 10%, 10 dB down from the 100% acquisition is reported.
 - When set to 50%, 3 dB down from the 100% acquisition is reported.
 - When set to 90%, 0.5 dB down from the 100% acquisition is reported.

Grid

Enables and disables the display of a 10 x 10 grid on the FieldFox screen.

How to enable Grid display

- Press **Mkr ->/Tools**
- Then **Grid**
 - **OFF** Grid OFF
 - **ON** A grid of X/Y lines appears on the screen.

Trace Memory

A memory trace is a pulse measurement **Tr 1** data trace (NOT the trace in the Zoom window) that has been stored in the FieldFox volatile memory. It then becomes static, meaning it is not updated with normal pulse measurements. It can be displayed on the screen by itself, or with a pulse trace for comparison purposes.

The **Tr 1** data trace is displayed in **yellow**.

The memory trace is displayed in **blue**.

How to display data and memory traces

- Press **Trace 6**.
- Then **Trace Memory**
- Then **Data->Mem** to store the current live trace into memory. A ‘beep’ sounds to confirm the data trace has been saved to memory. There is no display annotation that indicates that the memory trace has been stored.
 - Press **Data** to view only the data trace.
 - Press **Memory** to view only the memory trace.
 - Press **Data & Memory** to view both the live trace and the stored memory trace.

Pulse Measurements Mode – Option 330
Pulse Measurement Settings

19 VVM (Vector Voltmeter) Mode - Option 308

VVM Mode (Option 308) measures the electrical length of cables and other devices. The 1-Port Cable Trimming and 2-Port Transmission measurement displays the electrical length in both Magnitude and Phase.

Figure 19-1 Display for the 1-Port Cable Trimming measurement

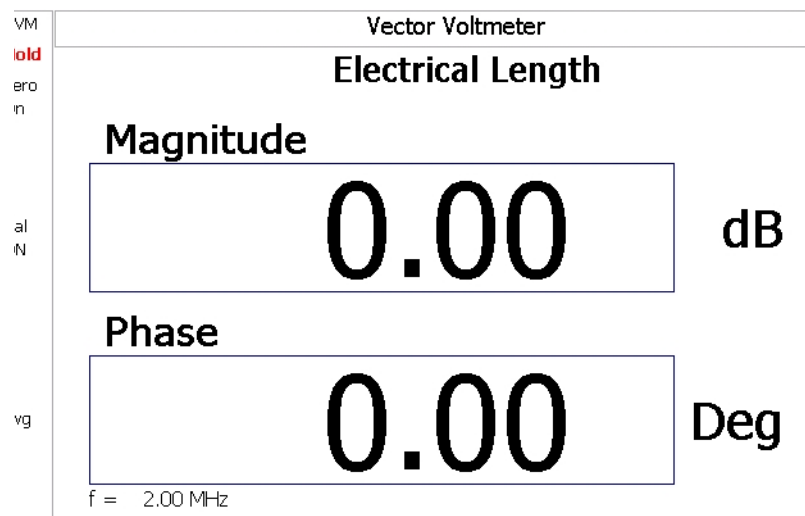

In this Chapter

- “Overview” on page 335
- “Measurement Selection” on page 336
- “Frequency Selection” on page 336
- “Display Resolution” on page 336
- “IF Bandwidth” on page 337
- “Output Power” on page 337
- “Averaging” on page 338
- “Single or Continuous Measure” on page 339
- “VVM Calibration” on page 339
- “Zeroing” on page 339

Procedures

[“1-Port Cable Trimming Measurements ” on page 341](#)

[“2-Port Transmission Measurements” on page 343](#)

[“A/B and B/A Measurements” on page 345](#)

Overview

In the FieldFox, both 1-port and 2-port measurement types use a different configuration setup from the HP/Keysight 8508A Vector Voltmeter.

Figure 19-2 Typical 8508A measurement configuration –as shown in the 8508A manual.

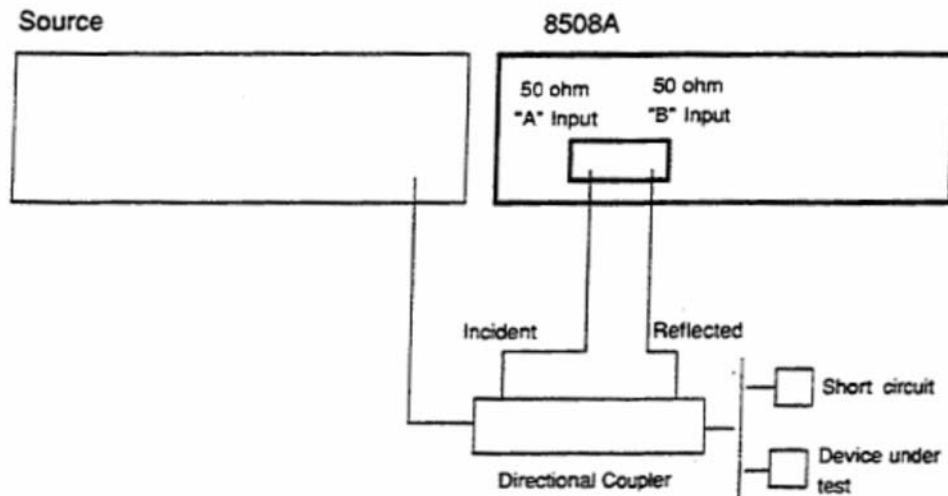

The above block diagram requires an external source and directional coupler to measure the electrical length of a DUT or cable to be trimmed. Separate paths are used to measure the Incident signal (A) and Reflected signal (B). To measure the ratio of the Reflected/Incident signals, you were required to select B/A for both the Magnitude and Phase display.

In the FieldFox, the source and directional coupler are inside the instrument. This allows you to connect the DUT to ONLY the FieldFox PORT 1, with NO external instruments, in order to make Cable Trimming measurements.

See the FieldFox block diagram and Cable Trimming procedures beginning in ["1-Port Cable Trimming Measurements" on page 341](#).

VVM Mode Settings

Select VVM Mode before making any setting in this section.

How to select VVM Mode

- Press **Mode**
- Then **VVM**

Measurement Selection

How to select a VVM Measurement

- Press **Measure 1**
- Then choose from the following:
 - **1-Port Cable Trimming** 1-port reflection measurement. Learn how to make this measurement in [“1-Port Cable Trimming Measurements” on page 341](#).
 - **2-Port Transmission** 2-port transmission measurement. Learn how to make this measurement in [“2-Port Transmission Measurements” on page 343](#).
 - **B/A** and **A/B** 2-port ratioed receiver measurements using external sources. Learn more in [“A/B and B/A Measurements” on page 345](#).

Frequency Selection

How to set Frequency

- Press **Freq/Dist**
- Then **Frequency**
- Enter a value using the numeric keypad, the **▲▼** arrows, or the rotary knob.
- After using the **▲▼** arrows or the rotary knob, press **Enter**. The increment setting of the arrows is based on the current span and can NOT be changed in VVM Mode.
- After using the keypad, select a multiplier key. Learn about multiplier abbreviations in [“Multiplier Abbreviations” on page 41](#).

Display Resolution

You can display either one digit or two digits after the decimal point for both magnitude and phase readings.

This setting survives a Preset and Mode Preset.

How to set Resolution

- Press **Scale/Amptd**
- Then **Resolution**
- Then choose:
 - **1** 0.0 (default)
 - **2** 0.00

IF Bandwidth

Reducing the IF receiver bandwidth reduces the effect of random noise on a measurement. However, narrower IF bandwidths cause longer measurement times.

For highest accuracy, Zero AFTER changing the IF Bandwidth. Learn about Zeroing in [“Zeroing” on page 339](#).

How to set IF BW

- Press **BW 2**
- Then **IF BW**
- Then choose from the following:
 - **10 Hz | 100 Hz | 1 kHz | 10 kHz | 100 kHz**
 - **More 30 Hz | 300 Hz | 3 kHz | 30 kHz**

Output Power

Set the power level out of the FieldFox to High, Low, or manually set power level to a value between High and Low.

Generally, the high power setting is used when measuring passive, high-loss devices to place the signal farther from the noise floor. However, for devices that are sensitive to high power levels such as amplifiers, use the Low power setting.

For best measurement accuracy, use the Manual power setting at -15 dBm. After calibration, the power level can be decreased for amplifiers, or increased for higher dynamic range.

CAUTION

Power Level settings in this mode will NOT change Power Level settings in other modes. To help prevent damage to your DUT, use caution when changing modes with your DUT connected to the FieldFox test ports.

How to set Output Power

- Press **Meas Setup 4**.
- Then **More**
- Then **Output Power**
 - **High** (Default setting) Sets output power to the maximum achievable power at all displayed frequency.
 - **Low** Sets output power to approximately –45 dBm.
 - **Man** Set output power to an arbitrary value.
 - Then press **Power Level**
 - Then enter a value using the numeric keypad, the **▲▼** arrows, or the rotary knob.
 - Press **Enter**.

Averaging

Averaging helps to reduce the effects of random noise on a measurement. The FieldFox computes the displayed value over several consecutive readings. Average count determines the number of readings to average. The higher the average count, the greater the amount of noise reduction.

An average counter is shown in the left edge of the screen as **Avg N**. This shows the number of previous readings that have been averaged together. When the counter reaches the specified count, then a 'running average' of the last **N** readings is displayed.

Average count = 1 means there is NO averaging.

This setting can be changed at any time without affecting calibration accuracy.

How to set Averaging

- Press **Meas Setup 4**
- Then **More**
- Then **Avg N** where **N** is the current count setting.
- Enter a value using the numeric keypad. Enter **1** for NO averaging.
- Press **Enter**.

To restart the averaging process, press **Meas Setup 4**, then **More**, then **Restart**

Single or Continuous Measure

This setting determines whether the FieldFox measures continuously or only once each time the **Single** button is pressed. Use **Single** to conserve battery power or to allow you to save or analyze a specific measurement.

This setting can be changed at any time without affecting calibration accuracy.

How to set Single or Continuous

- Press **Meas Setup 4**
- Then choose one of the following:
 - **Single** Automatically sets Continuous OFF and causes the FieldFox to make ONE measurement, then hold for the next **Single** key press. The **Hold** annotation changes to an arrow --> while the measurement occurs.
 - **Continuous OFF** and **Hold** both put the FieldFox in **Hold** mode.
 - **Continuous ON** Makes continuous measurements. This is the typical setting when battery power is not critical.
- You can also use **Run / Hold +/-** to toggle between Single and Continuous.

VVM Calibration

CalReady is accurate for most zeroed VVM measurements at frequencies below about 6 GHz. For the very highest accuracy, especially above 6 GHz, then perform a QuickCal or Mechanical Cal. Learn more in [“How to Perform a Calibration” on page 121](#).

NOTE

QuickCal is only available on N991xA/2xA/3xA models.

Press **Zero OFF** before calibrating (sets Zero to OFF).

Zeroing

Zeroing, also known as Normalization, or Data/Memory, simply “Zeroes” the Magnitude and Phase display when **Zero ON** is pressed. All subsequent measurements are relative to the measurement that was made when Zero was pressed.

When an instrument state is saved with Zero ON, the zeroing data is saved with the state file, similar to how a calibration is saved with a state file.

- When performing a 1-Port Cable Trimming operation, a reference cable is connected and measured. Then Zero is pressed, and subsequent cables are measured and trimmed to match electrical length of the reference cable.

- For 2-port measurements, Zero is typically pressed when a THRU connection is made in place of a DUT. Learn more in [“2-Port Transmission Measurements” on page 343](#).

Press Zero OFF before performing a QuickCal or Mechanical Cal (sets Zero to OFF).

NOTE

QuickCal is only available on N991xA/2xA/3xA models.

How to select Zeroing

- Press **Meas Setup 4**
- Then **Zero Ref**
 - **Open** – select to display Phase = 0.0 Deg when zeroed.
 - **Short** - select to display Phase = 180.0 Deg when zeroed.
- Then **Zero ON**
- Select **Zero OFF** to turn zeroing off.

1-Port Cable Trimming Measurements

A 1-Port Cable Trimming measurement is used in a cable fabrication procedure to validate proper electrical length.

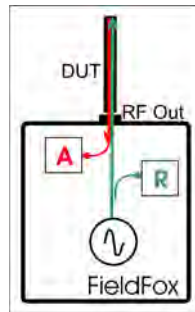

- The R receiver measures incident signal (green line) out of the source.
- The A receiver measures reflected signal (red line) from the end of the DUT (black line).
- In VVM mode, the display ALWAYS shows ratioed (A/R) measurements which is the electrical length of the DUT.

How to make a 1-Port Cable Trimming Measurement

1. Press **Mode** then **VVM** then **1-Port Cable Trimming**.
2. Press **Freq/Dist** then enter the frequency for the measurement.
3. To improve measurement stability, change the IF Bandwidth, Output Power, and Averaging settings as needed.
4. Press **Meas Setup 4** then **Zero OFF**.
5. Optionally calibrate the FieldFox. Learn more about VVM calibration in “**VVM Calibration**” on page 339.
6. To ensure that the calibration is adequate, perform the following **optional Measurement Verification** procedure.

NOTE

This measurement verification procedure is suitable for low frequency measurements. However, for high frequency measurements, a more sophisticated procedure is required.

- a. Connect a short standard to **PORT 1** where cables to be trimmed will be connected.
 - b. Press **Meas Setup 4** and press **Zero**.
 - c. Remove the short standard and connect the open standard.
 - d. Confirm that magnitude measurement is less than -0.1 dB and that the phase value reads 180° degrees.
7. Attach the shortest cable to the FieldFox **PORT 1** connector. This cable is the reference cable. Leave the end of the reference cable open (unterminated).
 8. Press **Meas Setup 4** then press **Zero**.

9. Remove the reference cable from the FieldFox **PORT 1** connector.
10. Connect an unterminated, longer cable to the FieldFox **PORT 1** connector.
11. Observe the displayed phase difference between the reference cable and the untrimmed cable.

NOTE

The VVM phase reading shows a maximum of $\pm 180^\circ$. Therefore, the electrical length of the untrimmed cable **MUST** be within 180° of the reference cable.

12. Carefully trim the cable until the phase shift reads zero. The attached cable's electrical length is now matched to the reference cable.
13. Repeat steps 10 through 12 for the remaining cables to be trimmed.

2-Port Transmission Measurements

A 2-Port Transmission measurement is used for measuring electrical length, insertion loss, gain, or isolation of a DUT at a single CW frequency. The FieldFox signal source is transmitted out the port 1 connector, through the DUT, and into the port 2 connector. In the following image, the gain of an amplifier is being measured.

Figure 19-3 2-Port Transmission measurement of an amplifier

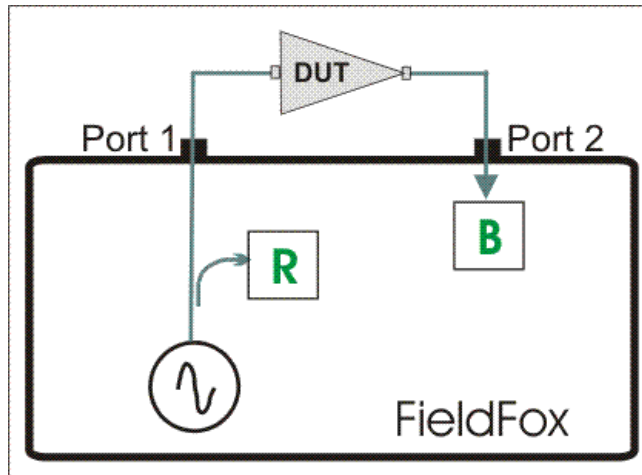

How to make a 2-Port Transmission Measurement

1. Press **Mode** then **VVM** then **2-Port Transmission**.
2. Press **Freq/Dist** and enter the measurement frequency.
3. Press **Meas Setup 4** then **More** then **Output Power**. Select **High** for passive devices. Select **Low** for amplifiers.
4. Calibrate the FieldFox using one of the methods described in “**VVM Calibration**” on page 339. Before performing a QuickCal or Mechanical Cal, press **Meas Setup 4** then **Zero OFF**.

NOTE

QuickCal is only available on N991xA/2xA/3xA models.

5. 5.Connect the DUT.

Notes:

- The magnitude value is the gain (positive value) or the loss (negative value) of the DUT.
- The phase value is the difference in phase (in degrees) between the DUT input and output.

VVM (Vector Voltmeter) Mode - Option 308
2-Port Transmission Measurements

- To measure isolation of the amplifier, reverse the connection to the amplifier (**PORT 1** to the amplifier output).

A/B and B/A Measurements

These measurements allow you to use the FieldFox A and B receivers, along with an external source, to make ratioed measurements.

NOTE

These measurements require the “Full 2-port S-parameters” option.

The image below shows a typical configuration for a B/A magnitude and phase measurement of a 2-port DUT. This DUT can be an antenna / probe setup. Using network analyzer terms, the image shows the A receiver as the reference receiver which measures the signal that is applied to the DUT. The B receiver is the test port receiver which measures the DUT response.

Figure 19-4

B/A Transmission measurement with external source

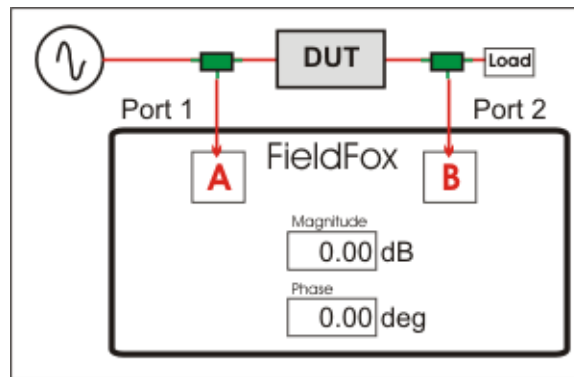

Procedure

1. Connect the external source's frequency reference output to the FieldFox **Freq Ref IN** on the top panel. If you are unable to use a common frequency reference, then increase the IFBW to ensure you are measuring the peak of the correct signal. After locating and tuning to the signal, you may be able to lower the IFBW to reduce noise.
2. On the FieldFox, select **System 7**, then **System Configuration**, then **Frequency Ref**, then **Freq Ref Source** then **Ext**.
3. Press **Mode**, then **VVM**, then **B/A** or **A/B**
4. The FieldFox internal source is NOT used, so the output power setting is not relevant.
5. To calibrate, replace the DUT with a THRU connection, preferably by connecting together the two Power Splitters (shown in green). For low frequency measurements, TEEs can be used.
6. Press **Meas Setup 4**, then **Zero**.
7. Connect the DUT and measure.

VVM (Vector Voltmeter) Mode - Option 308
A/B and B/A Measurements

20 ERTA (Extended Range Transmission Analysis) Mode - Option 209

ERTA (also known as **FoxTrot**) uses two FieldFox units to make long-distance scalar transmission measurements. One unit is the source and the other unit is the Receiver.

In this Chapter

“Overview” on page 348

“Requirements and Limitations” on page 349

“Start Connection Wizard” on page 350

“Configure Measurement Settings” on page 354

“Select Measurement” on page 354

“Normalize” on page 355

“Source Tracking Offset and Offset Reversal” on page 355

“Improve Dynamic Range” on page 356

“Source Enable and Source Mode” on page 356

Overview

ERTA uses two FieldFox units to make long-distance scalar, tracking transmission measurements. One unit is the source and the other unit is the Receiver.

Communication takes place between the two units with a LAN connection and hard-wired trigger signals. Once the two units are synchronized, the Receiver unit becomes the master and measures the output of a DUT, while the Source unit responds as follower supplying signal at the DUT input. The two units, possibly separated by hundreds of meters, step together through the selected frequency range making measurements such as long cable characterization.

With a power splitter at the Source unit, the SA Receiver can be used to measure the reference signal to make a true B/R ratio measurement. Because the reference trace is updated on every sweep, there is no need for static trace normalization. Accuracy is further enhanced with input and output cable corrections. Furthermore, the alignment process keeps the SA receivers calibrated. For information on alignments, refer to the SA mode chapter's section, [“Alignments” on page 177](#).

Requirements and Limitations

Requirements

- Two FieldFox units with option 209 installed. SA Mode is required for option 209.
- Ethernet LAN cable(s). Either TWO cables that are used to connect both units to the internet or ONE cable that is long enough to connect the two FieldFox units. This may require a cross-over cable.

NOTE

When you change network connections, it may take up to 2 minutes for the old address to be replaced by the new address. If the FieldFox was initially assigned an IP address by a DHCP server, and then the FieldFox LAN connection with a DHCP server is removed and is the FieldFox is reconnected to a LAN segment with no DHCP server (such as a direct connect to another FieldFox), the FieldFox may take up to two minutes to self-assign an automatic private IP address. During this connection time the last recognized DHCP address is displayed on the FieldFox, but is invalid.

-
- Two trigger cables that are long enough to connect the two FieldFox units, each with SMB (m) to SMA (f) connectors.
 - RF cabling to and from DUT.
 - Power Splitter (Optional) for enhanced B/R ratio measurements.

Limitations

The following SA features are removed in ERTA mode (Option 209):

- Channel Measurements, Tune and Listen, Interference Analysis, Radio Standards, and Sweep Triggering.

The following SA features are disabled during partnership synchronization:

- Video BW, SwpAcquisition, Frequency Count, Record/Playback, and certain Amplitude Units.
- The only keystrokes allowed on the Source unit are **Send Text Message** and **Exit**.

Start Connection Wizard

Use the FieldFox Connection Wizard to guide you through the following physical setup.

On the Receiver unit:

- Press **Mode** then **ERTA**
- Then **Meas Setup 4** then **Connection Wizard** then **Start**.

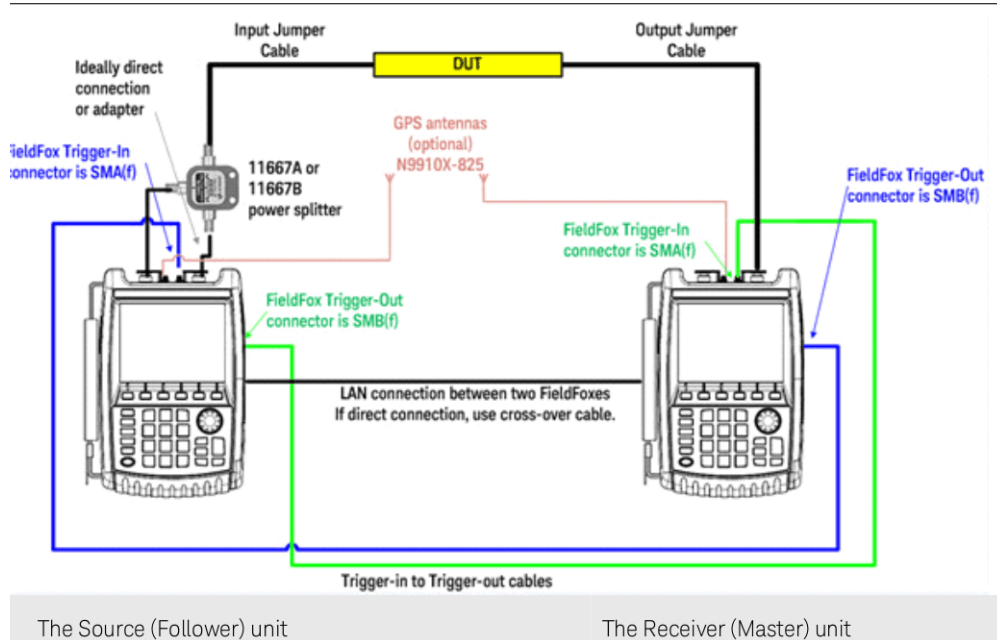

STEP 1: Select [Start] when ready

- Press **Start**
- At any step, press **Exit** to end the wizard.

STEP 2: Connect Trigger and LAN cables

- **LAN:** Connect a LAN cable to each unit. The units can either both be connected to the internet on the same network through a switch or router, or they can be connected directly to each other (a crossover cable may be necessary).
- **Trigger signals:** On each unit, connect the **Ref/Trig Out** SMB (m) connector on the FieldFox side panel to the **Ref/Trig In** SMA (f) connector on the other FieldFox top panel.
- **RF connections**
Preferred method (pictured above):

- On the Source unit, connect the Port 1 RF Output connector to the input of a power splitter.
- Connect one power splitter output to the Source unit Port 2 RF Input.
- Connect the other power splitter output to the DUT input.
- Connect the DUT output to the Port 2 RF Input of the Receiver unit.

Simplified method (not shown):

- Omit the power splitter. Connect the Source unit Port 1 RF Output connector to the DUT input. **The measurement is a raw B receiver.** Specs do NOT apply.

STEP 3: Select LAN address of ERTA Partner

The Receiver unit is the master partner, annotated with **RCVR Master**.

The Source unit is the follower partner, annotated with **SRC Follower**.

On the Receiver unit:

- Press **ERTA Partner (not specified)**. The IP addresses of potential FieldFox units are displayed. Select the IP address of the Source unit. If 10.10.10.1 appears, then NO FieldFox units were found. The LAN setting “Obtain IP Address using” MUST be set to DCHP. Learn more in **“LAN Settings” on page 488**. Also be sure that Opt. 209 has been installed correctly on the Source unit.
- Press **Continue**.

STEP 4: Test Partnership

- Press **Test Partnership**. If the Source unit is NOT already in ERTA mode, it will be started, which may take a several seconds. When successful, LAN OK and Trigger OK will appear on the screen.
- If either the LAN or Trigger test fails, then press **Clear Test**, then **Test Partnership** to retry the test.
- Optional: Press **Send Text Message**, then enter a message to send to the Receiver unit. A LAN connection is necessary. For quick communication, custom Keywords can be setup using the FieldFox labeler. Learn how in **“Edit Keywords” on page 509**.

Any of the following will end the partnership:

- Press **EXIT Partnership**
- Select Global or Mode Preset
- Change Modes
- Recalling a non-ERTA State file. Recalling an ERTA State file can re-establish a partnership if the Source unit is still on the network at the same location.

- Press **Continue**.

STEP 5: Measure Jumper Cables

These steps can be used to characterize an Input and Output jumper cable that may be connect the DUT to the FieldFox. The loss of the characterized jumper cables can then be removed from the DUT measurements. The measurements are stored to the internal Cables folder using an auto-generated *.csv filename.

- The Input cable is attached between the Source/splitter output and the DUT input.
- The Output cable is attached between the DUT output and the Receiver unit.

NOTE

For optimum flexibility, use the Scale, then More, then Corrections menu to measure, save, and recall cable characterizations. These softkeys are duplicated from the SA Field Strength - Antenna/Cable characterization. Learn more in [“Field Strength Measurements” on page 154](#).

Figure 20-1

Input and Output jumper cables are measured on the Receiver unit

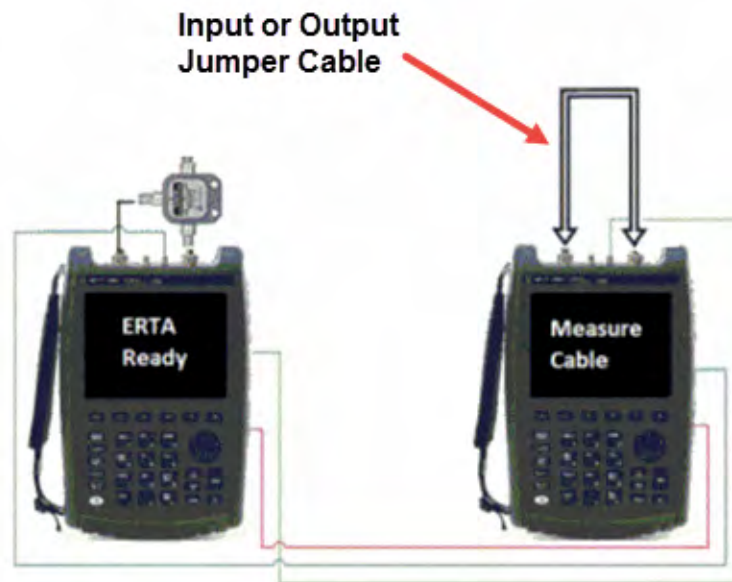

If your DUT input **AND** output is connected directly to the FieldFox, or you choose to ignore the loss of BOTH jumper cables, then press **Skip this step**.

Otherwise, press **Measure Jumper Cables**.

Do the following for both the Input and Output jumper cables:

- Press **Skip this step** to skip the cable measurement.
- Otherwise, connect the Input / Output jumper cable as shown below, then press **Measure Input (or Output) Cable**.

ERTA (Extended Range Transmission Analysis) Mode - Option 209
Start Connection Wizard

- Press **Re-measure** or **Continue**.
- Press **Apply Corrections ON** to remove the jumper cables from subsequent DUT measurements.
- Press **Done** to exit the Connection Wizard.
- On the Receiver unit, press **LEAD ERTA Partnership**. The Source unit enters ERTA mode as the follower.

Configure Measurement Settings

On the Receiver unit, select measurement settings such as Frequency range, Res Be, Points, and so forth. Zeros pan frequency is allowed even though the frequency is fixed and no stepping is required.

Learn about these settings in **“SA Mode Settings” on page 146.**

Select Measurement

The following traces are provided for your convenience. They are all configured as Clear/Write.

Press **Meas 1**, then choose one or more of the following:

Softkey	Shown on screen	Description
Input Power R	2 w r	R receiver. Reference power measured by the Source unit before entering the DUT.
Output Power B	3 w B	B receiver. Power out of the DUT measured at the Receiver unit.
Gain or Loss B/R	1 w G	Gain or Insertion Loss. The B receiver data divided by the R receiver data (B/R) This measurement can be displayed accurately with, or without, displaying the R or B measurements.

Figure 20-2

Input power, Output power, and gain measurement traces



To change the trace numbers of these three measurements, or to select a trace state other than Clear/Write, press **Trace 6**.

Learn more about Trace Display States in [“Trace Display States \(SA Mode\)” on page 175](#).

Normalize

Normalize can be used to quickly provide ‘zeroing’ for any of the ERTA (B, R, or G) traces. On the sweep AFTER selecting Normalize, Trace 1 is copied to Trace4. It is then put into View state and subtracted from that input on subsequent sweeps. Any trace (1, 2, or 3) which is set to process that same input (B, R, or G) will therefore be processing normalized measurement data. This continues as long as the frequency span, number of points, and the trace input (B, R, or G) is NOT changed. If any of these settings change, Normalize is deactivated.

How to Normalize the B trace

- Press **Meas Setup 4**
- Then **Remote Source**
- Then **Normalize ON**

Source Tracking Offset and Offset Reversal

Source offset tracking is used to offset the Source frequency from the Receiver frequency by a fixed offset at every tune frequency. This feature is used when the DUT contains a frequency converter.

How to set Tracking Offset and Offset Reversal

- On the Receiver unit, press **Meas Setup 4**,
- Then **Remote Source**
- Then **Advanced**
- Then choose one or both of the following:
 - **Tracking Offset** Enter an offset value.
 - **OfsTrkReversal** Determines whether Receiver Freq is added to or subtracted from the Offset Freq.
 - **OFF** SourceFreq = Offset + RecFreq. Use to measure Upconverters.
 - **ON** SourceFreq = Offset - RecFreq. Use to measure Downconverters. The source sweeps in Reverse direction.

NOTE

The Offset Freq. MUST be larger than the Receiver Stop Freq.

Improve Dynamic Range

The following settings can be made to reduce measurement noise which improves Dynamic Range.

Increase source power as much as possible while maintaining a leveled source.

How to set Source Power

- Press **Meas Setup 4**
- Then **Remote Source**
- Then **Source Power**
- Then either **Max Power** or **Leveled** - Increase source power until the unlevelled warning appears. Then decrease power until power is again leveled.

To further reduce measurement noise, on the Receiver unit:

- Reduce **Attenuation** to 5 dB, then turn the **Preamp ON**. Learn how in [“Preamplifier Control \(Opt 235\)” on page 153](#).
- Decrease the **Res BW**. Learn how in [“Resolution Bandwidth \(Res BW\)” on page 163](#).
- Set **Frequency Reference** to **GPS** on both units. This requires Option 307 (Built-in GPS) and two GPS antennae. The GPS reference can be enabled for several sweeps. Then if you move to a location without an adequate GPS signal, Hold-over Mode will occur. Learn more about GPS as a frequency reference in [“Frequency Reference Source” on page 484](#).

Source Enable and Source Mode

When **Source Enable [OFF]** is selected, or when **Source Mode [CW or CoupledCW]** is selected, then synchronization ends and the two partner units revert to general SA (non-tracking) sweeps. However, the units are still in partnership, and other settings continue to be synchronized such as Frequencies, ResBw, and Points.

21 AM/FM Metrics (SA Only and Option 355)

NOTE

The FieldFox assumes you have manually set up the CF, span, and amplitude settings. Refer to [Chapter 9, "SA \(Spectrum Analyzer\) Mode."](#)

In this Chapter

["Using AM/FM Metrics" on page 357](#)

["SINAD and THD Calculations" on page 364](#)

["Interpreting AM/FM Metrics Error Messages" on page 367](#)

Using AM/FM Metrics

Using FieldFox's analog demodulation, users maintaining AM/FM radio systems can demodulate and characterize AM and FM signals. They can tune to the signal and listen to the audio tones using FieldFox's built-in speakers or a headphone. They can also display the RF spectrum, the demodulated waveform and AM/FM metrics such as carrier power, modulation rate, and SINAD.

AM/FM Metrics enables you to make the following measurements:

- | | |
|------------------|--|
| AM Measurements: | – AM Measurements: Carrier power, AM rate, AM modulation index |
| FM Measurements: | – FM deviation (peak and RMS), Modulation Rate, Carrier power, Demodulated voltage, SINAD, THD (total harmonic distortion) |

And, can be enabled/disabled simultaneously with Tune and Listen.

Overview of Measurement Types

If you are familiar with the AM/FM measurements and terms, skip to ["How to Set Up AM/FM Metrics" on page 360.](#)

Table 21-1 Measurement Details

Measurement details	
Modulation Rate	The modulation rate quantifies how fast the modulation is and equates to the frequency of the baseband signal that modulates the carrier.
SINAD (Signal to Noise and Distortion Ratio)	<p>Another commonly used distortion measure is signal to noise and distortion ratio (SINAD). SINAD, in nature, is the reciprocal of the modulation distortion provided by the “distortion/total Vrms,” but the SINAD is usually expressed in a logarithmic term as follows:</p> <p>Where:</p> <p>S = Signal Power</p> $D = \sum_{k=0}^n D_n$ <p>N = Noise</p> <p>SINAD = [(S + D + N) / (D + N)] OR</p> <p>Refer to “SINAD and THD Calculations” on page 364.</p>
THD (Total Harmonic Distortion)	<p>The total harmonic distortion (THD) measurement further isolates the total harmonic distortion component from the noise component in the total unwanted signal. It helps the user to troubleshoot the root causes of modulation distortion.</p> <p>S = Signal Power</p> $D = \sum_{k=0}^n D_n$ <p>N = Noise</p> <p>THD = [(D + N) / (S + D + N)]</p>
RF spectrum of the modulated signal	This is the most traditional spectrum analyzer measurement viewing the modulated carrier signal power in frequency domain. Prior to being modulated, the signal power of a sinusoidal carrier concentrates at the carrier frequency. By contrast, modulation causes sidebands indicating the power redistribution over frequencies. The pattern of the sidebands depends upon the modulation format.
Demod waveform	This measurement retrieves the baseband signal from the modulated signal via the demodulation process, and displays the baseband signal in a pattern of modulation depth/deviation versus time. Since the modulation depth/deviation is directly proportional to the instantaneous amplitude of the baseband signal, the measurement result helps to intuitively evaluate the quality of the baseband signal.
AM modulation depth	AM modulation depth = (Peak-to-Peak / 2)

Table 21-1 **Measurement Details**

Modulation Metrics	
FM deviation	The FM deviation reflects the amount of the frequency modulation to which the baseband signal modulates the carrier signal. The quantity being measured is the peak frequency deviation that is the maximum frequency excursion from the carrier frequency.
Carrier power	This measures the power of the carrier signal without the modulation. Ideally, power for a sinusoidal carrier signal is concentrated around its carrier frequency.

How to Set Up AM/FM Metrics

- Connect a test tone to the FieldFox SA Port 2 (Port 2)
- Press **Measure**
- Then **Analog Demod / Tune & Listen**
- Then choose one of the following:
 - **AM Metrics** or
 - **FM Metrics**

NOTE

Selecting FM Wide vs. FM Narrow does not effect the displayed waveforms or metrics. But, if you are using the Audio Demod feature and listening to the demodulated waveform, then select the appropriate FM type, because the tones do differ based on the FM type selected. Refer to [Table 21-1 on page 358](#).

Left display - Frequency Spectrum (Power vs. Frequency)

Right display - Demodulated waveform vs. time where **Demod SwpT** sets the width of the demod window.

- Then **Freq/Dist** > **Center** to set the carrier frequency.
- Set **Freq Span** so that all sidebands above -60 dB are displayed in the left window.
- Optionally, adjust the **Res BW** to better identify side bands.

Metrics are displayed in the **AM/FM Modulation Metrics** table on the FieldFox. For AM and FM Metrics examples, refer to [Figure 21-1 through Figure 21-8 on page 369](#).

Figure 21-1 AM Metrics - Example 1

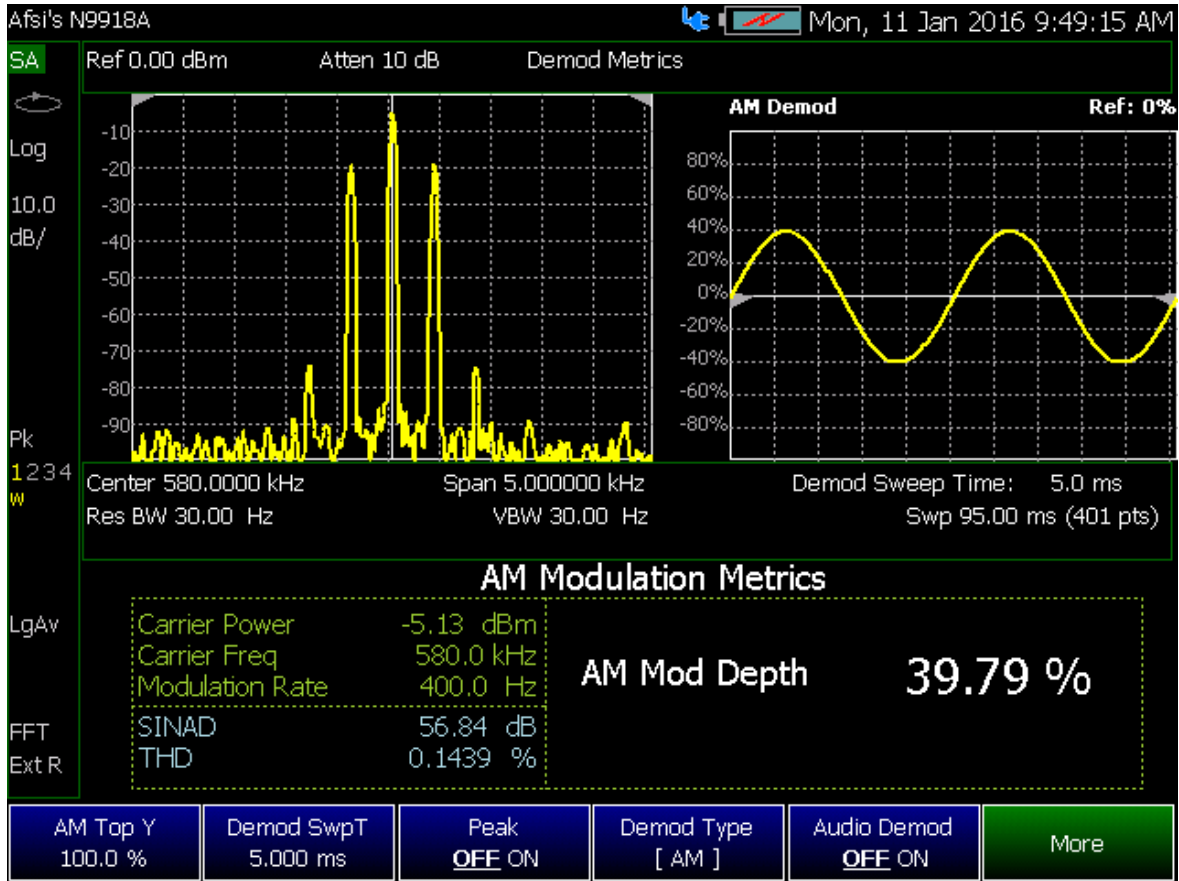

Figure 21-2 AM Metrics - Example 2

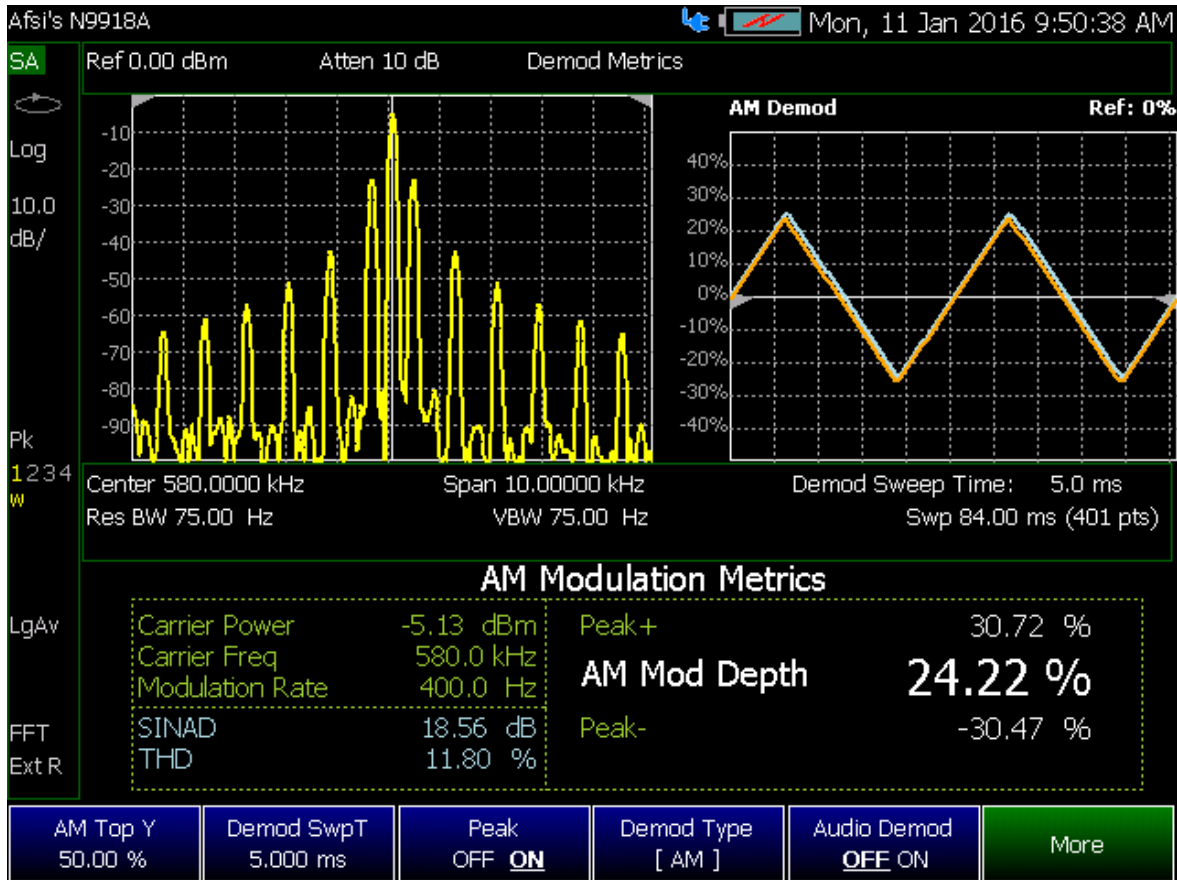
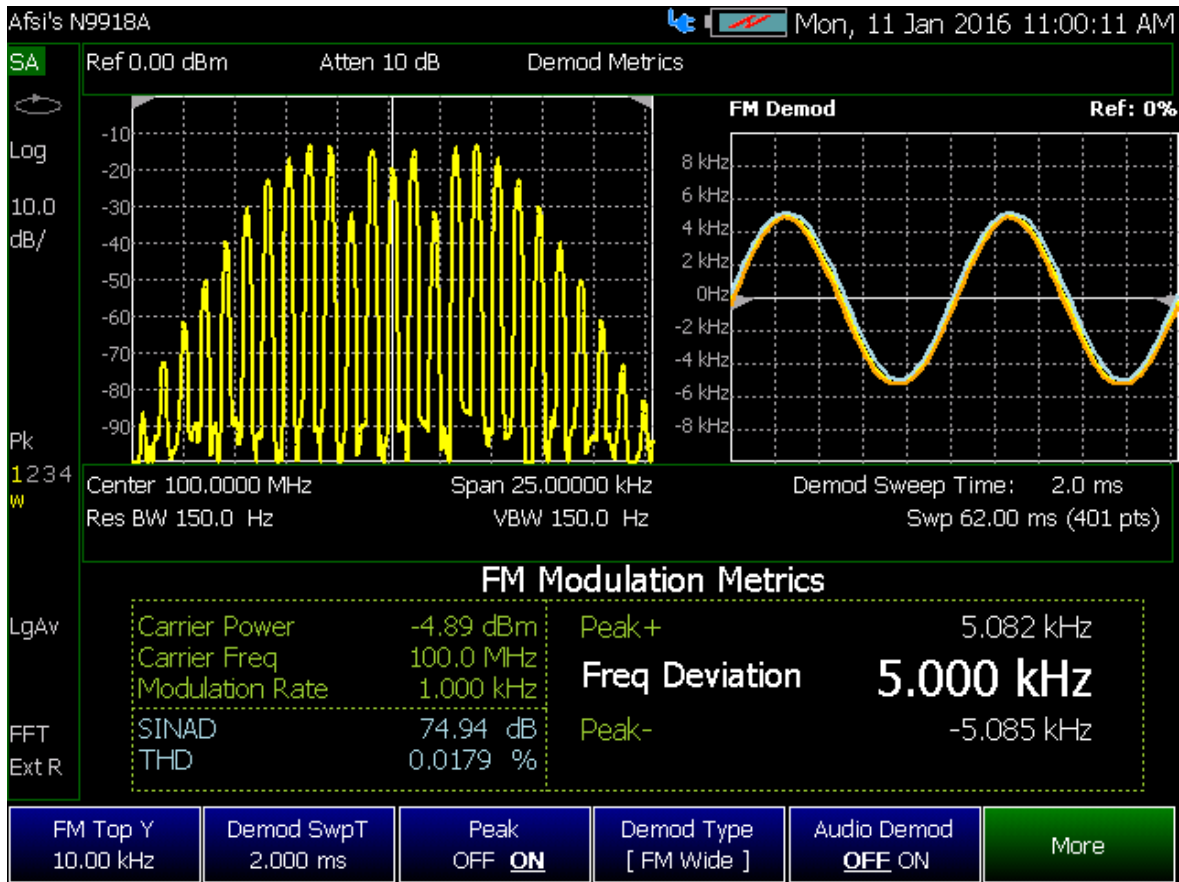

Figure 21-3 FM Metrics - Wide band Example



SINAD and THD Calculations

- FieldFox converts the audio waveform to the audio frequency spectrum using an FFT (i.e., The FFT result is not displayed). Refer to [Figure 21-4 on page 364](#).
- The FFT waveform is used to calculate SINAD and THD distortion metrics
- The fundamental signal, harmonics, and noise from 0 Hz to 24 kHz are applied to the formulas. Refer to [Figure 21-5 on page 365](#).
- For more on calculations, refer to [“Overview of Measurement Types” on page 357](#).
- See also, <http://literature.cdn.keysight.com/litweb/pdf/5991-4913EN.pdf>

Figure 21-4 Audio Waveform with FFT Calculations

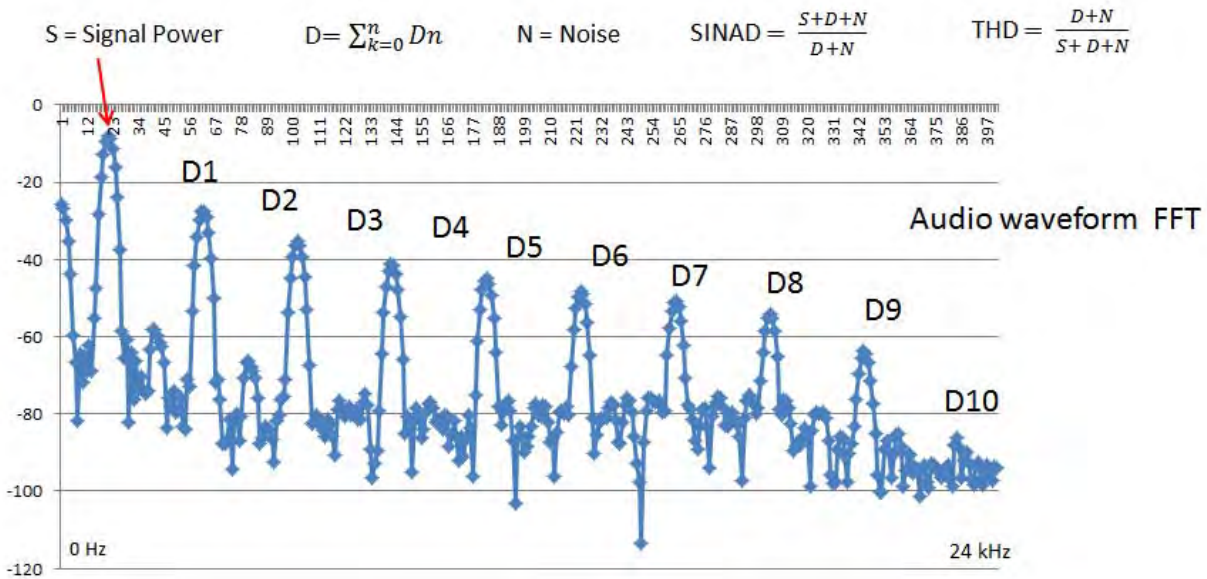

Figure 21-5 SINAD and THD Results - Example 1

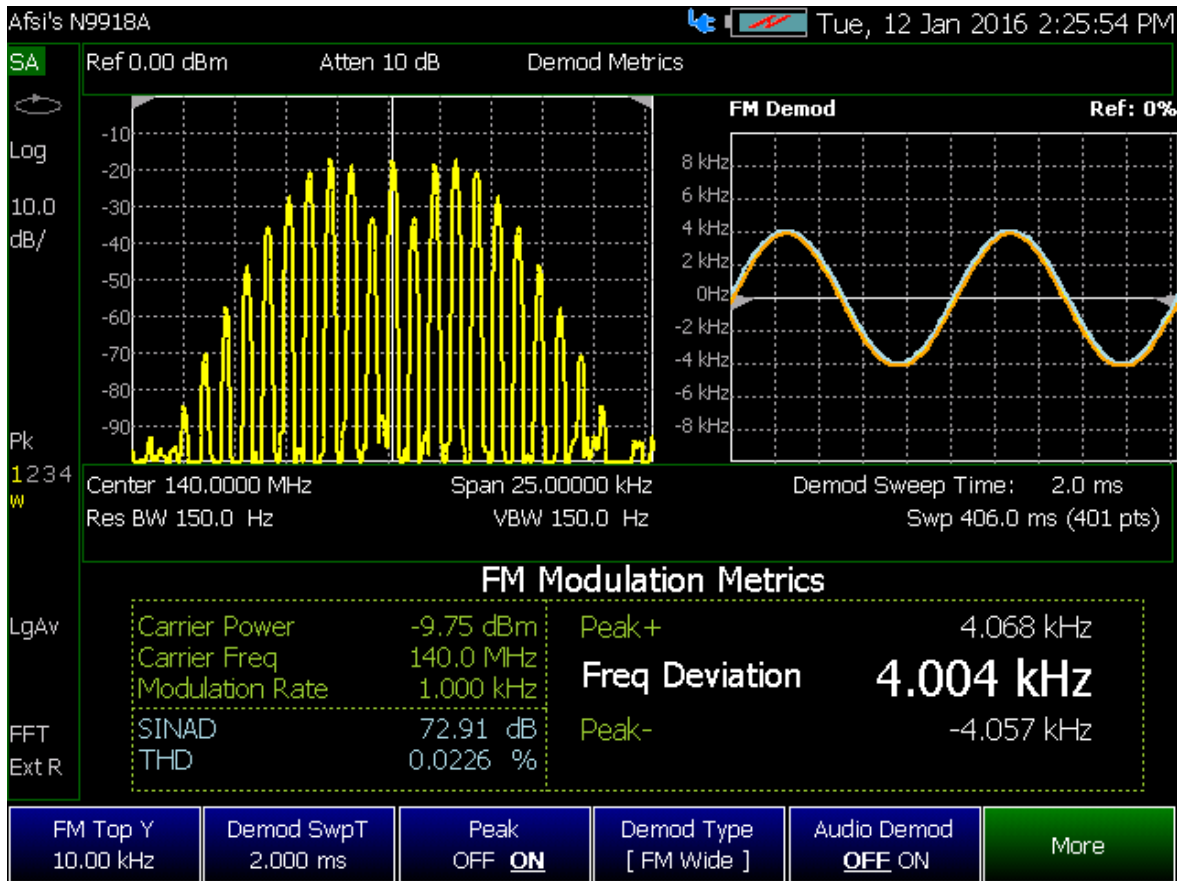
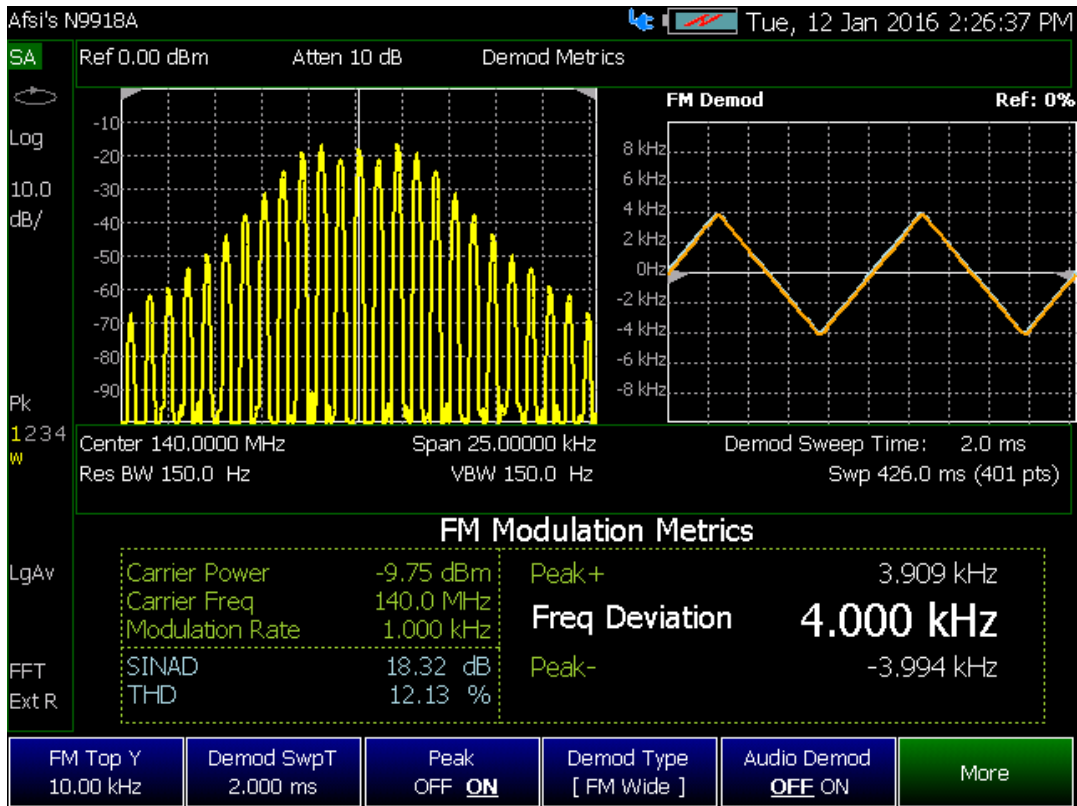

Figure 21-6 SINAD and THD Results - Example 2



Interpreting AM/FM Metrics Error Messages

This section discusses possible AM/FM Metrics error messages and how to correct them.

Test Tone Not Found

A Test Tone Not Found message is displayed under the following circumstances:

- FieldFox frequency span is too wide
- No side lobes are displayed in the results

Refer to the examples in **“Test Tone Not Found - Example” on page 368** and **“Test Tone Not Found - Corrected Example” on page 369**.

Test Tone Not Found - Example

The following response had the following settings:

- Source CF: 140 MHz
- FM Deviation: 18 kHz
- Modulation Rate: 1 kHz

Reasons for error:

- Frequency span of 1.0 MHz is too wide
- No side lobes displayed, so test tone not found

Figure 21-7

Test Tone Not Found - Example

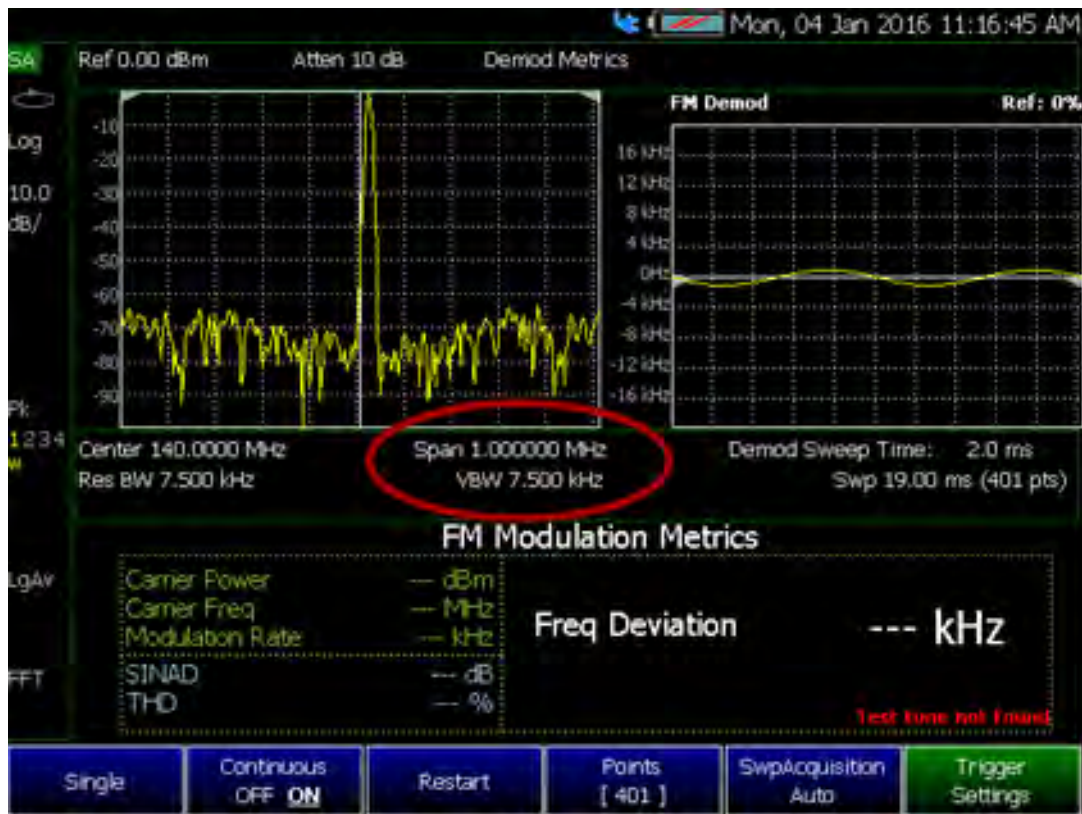

Test Tone Not Found - Corrected Example

The following response was corrected with these setting changes:

- Frequency set to narrower frequency span of 50 kHz
- Ideally the frequency span should show the modulation envelope down to –60 dB below the RF power level

Response corrected, because:

- Narrowing the frequency span enables the modulation envelope's side lobes to be identified
- FM algorithm identifies the side lobes
- The algorithm matches the modulation envelope to the mathematically calculated FM modulation or distortion patterns

Figure 21-8 Test Tone Not Found - Corrected Example

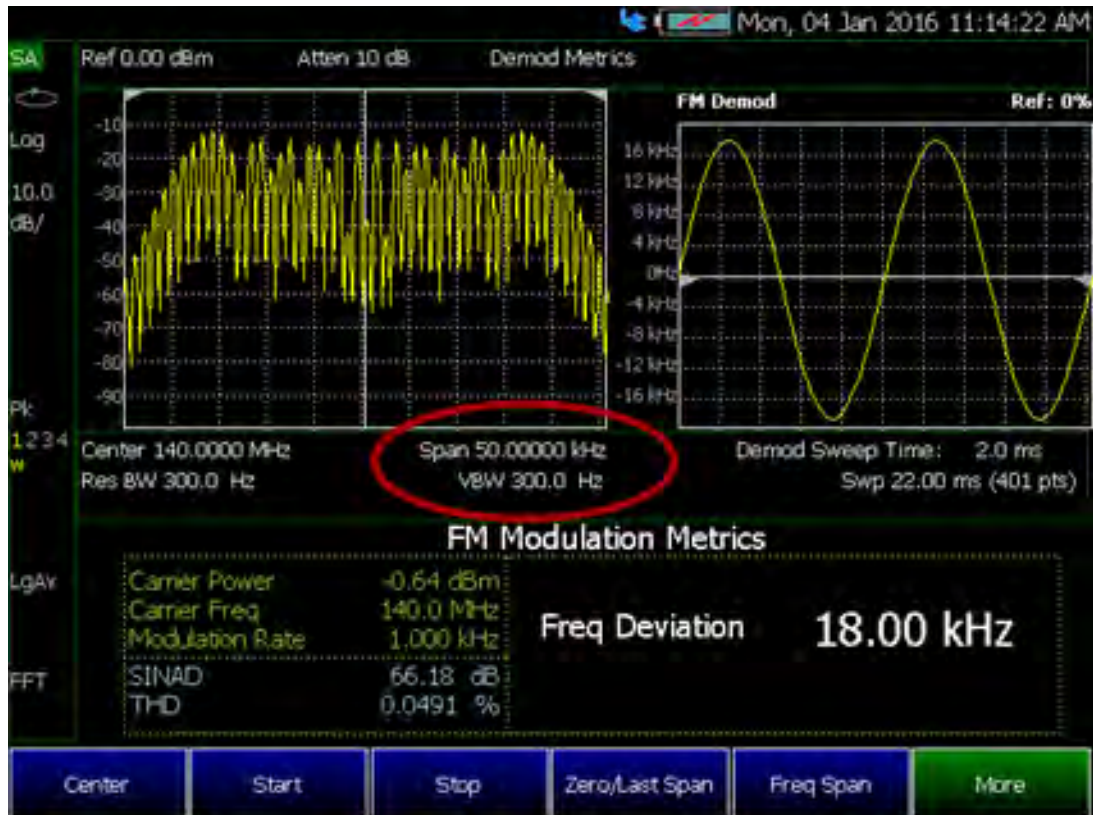

AM/FM Metrics (SA Only and Option 355)
Interpreting AM/FM Metrics Error Messages

22 Channel Scanner (Option 312)

In this Chapter:

[“Using Channel Scanner” on page 371](#)

[“How to Set Up Channel Scanner” on page 372](#)

Using Channel Scanner

Channel Scanner enables you to do the following:

Measure and display channel power vs. frequency for up to 20 channels simultaneously.

Six Display Types:

- Bar graph vertical display orientation
- Bar graph horizontal display orientation
- Channel Power
- Strip Chart
- Strip Chart and Overlay
- Scan & Listen

Color Coded Display Types:

- Specify high and low power with color bars

Flexible Data Sorting:

- Sort results displayed by power or frequency, low to high, or high to low

Data Logging. Record GPS stamped data measurements

- Define measurement interval by time or distance
- Show results in spectrogram
- Replay files on Google Maps or Google Earth

Figure 22-1 Display Example: Measure 5 Channels Spaced 2 MHz Apart

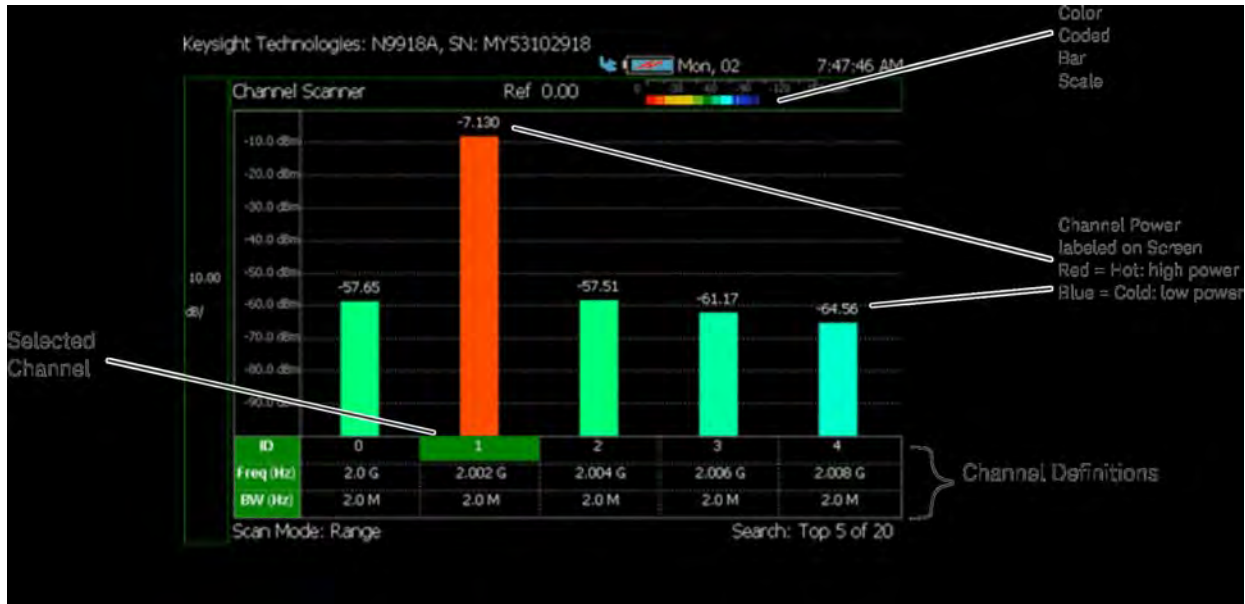

How to Set Up Channel Scanner

This section briefly reviews the steps in setting up a channel scan measurement. If you are not familiar with this process or would like more information, refer to [“How to Define a Channel and Use Channel Scanner”](#).

1. Define some channels (refer to [“How to Define a Channel and Use Channel Scanner”](#)).
 - a. Select a **Scan Mode**—choose:
 - **Range** Specify total channels, channel spacing or
 - **Custom List** Specify a list of channels from an editor
 - b. Then modify channels based on the selected scan mode
2. Select **Display Type**—choose:
 - **Bar ChartV** or
 - **Bar ChartH** or
 - **Channel Pow** or
 - **Strip Chart** or
 - **Chart Overlay** or
 - **Scan&Listen**
3. Modify scale and specify color bar coding—Modify the scale and assign colors to low and high power channels (bars):

Press **Scale/Amptd**

Then one of the following:

- **Red Limit** to set the power level and color scale for high power channels.
- **Blue Limit** to set the power level and color scale for low power channels.
- Others: **Scale**, **Ref Level**, **RF Atten**, etcetera as desired.

4. Enable **Data Logging** and set the **Record Settings**.

- **Record** or
- **Play** or
- **View**
- To set the **Record Settings**—choose:
 - **Meas Interval**
 - **Interval Time**
 - **Time Interval**
 - **Distance Interval** and or
 - **Auto Save** (default is On)

5. Then select the User Folder and save to *.KML or *.CSV file, **Save-Recall Rec-Playback**:

- Then **User Folder Def System**
 - **Def** – Sets the default User Folder path:
 - List files (*.csv and *.kml) are save-recalled to:
"CurrentDevice\ChannelScanner\Channelscanner\RecordPlayback\"
 - Record-Play files are save-recalled to:
"CurrentDevice\ChannelScanner\Channelscanner\RecordPlayback\"
 - Or
 - **System** – Sets the User Folder to the user defined system folder path/name:
 - List files are save to-from
"CurrentDevice\<UserSelectedFolder>\"
 - Record-Play files are save-recalled to:
"CurrentDevice\<UserSelectedFolder>\"

Refer to **“File Management” on page 497.**

Channel Scanner (Option 312)
How to Set Up Channel Scanner

- Then **File Type**
 - KML (default) or
 - CSV
 - Then **Save Log File.**
6. Export KML file into 3rd party mapping software (i.e., Google or Google Earth)

How to Define a Channel and Use Channel Scanner

Channel definitions consist of the following:

- Each channel is defined by CF and Integration BW.
- Frequency span is set automatically to 1.5 x Integration BW
- Power is measured over the Integration BW

Using Channel Scanner, refer to:

- **“Step 1A: Scan Mode: Range Channel Defined” on page 375** or
- **“Step 1B: Scan Mode: Custom List Channel Defined” on page 376**

Then:

- **“Step 2: Select Display Type” on page 377**
- **“Step 3. Modify Scale and the Display Color Bar Settings” on page 381**
- **“Step 4: Enable Data Logging and Record Results” on page 382**
- **“Save 5: Save the Log Results:” on page 384**
- **“Step 6: Import and Play back KML Files into 3rd Party Software (Example: Google Earth with Animation Tool)” on page 384**

Figure 22-2 Channel Definition



Step 1A: Scan Mode: Range Channel Defined

1. Define some channels: Press **Measure** > **Scan Mode** > **Range**
2. Press **Edit Range** and modify table items:
 - Total Channels
 - Search Count
 - Start Channel CF
 - CF Step Size

Figure 22-3 Range Table Settings



3. Press **Done**

Step 1B: Scan Mode: Custom List Channel Defined

1. Define some channels: Press **Measure** > **Scan Mode** > **Custom List**
2. Press **Edit Custom List** and modify table items:
 - Add table rows
 - Then for each row:
 - Edit Center Frequency (CF)
 - Edit Integration BW (IBW)

Figure 22-4 Custom List Table Settings

Use knob. Press [Edit] to make changes. Press [Done] to exit. Page 1/1

ID	CF	BW
Chan	Center	Integration BW
1	93.700000 MHz	100.000 kHz
1	100.100000 MHz	100.000 kHz
2	97.300000 MHz	100.000 kHz
3	99.700000 MHz	100.000 kHz
4	96.500000 MHz	100.000 kHz

Edit Next Page Previous Page Add Row Delete/Clear Done

3. Press **Done**
4. Press **Save Recall List** > **Save List** to save a custom list. See also “How to use the FieldFox labeler” on page 500.

NOTE

Press **Recall List** to bring back a previously stored custom list

Step 2: Select Display Type

Select one of the following display orientations:

- Select **Display Type**—choose:
 - **Bar ChartV** or
 - **Bar ChartH** or
 - **Channel Pow** or
 - **Strip Chart** or
 - **Chart Overlay** or
 - **Scan&Listen**

Figure 22-5 Bar Chart Vertical Display Type



Figure 22-6 Bar Chart Horizontal Display Type



Figure 22-7 Channel Power Display Type

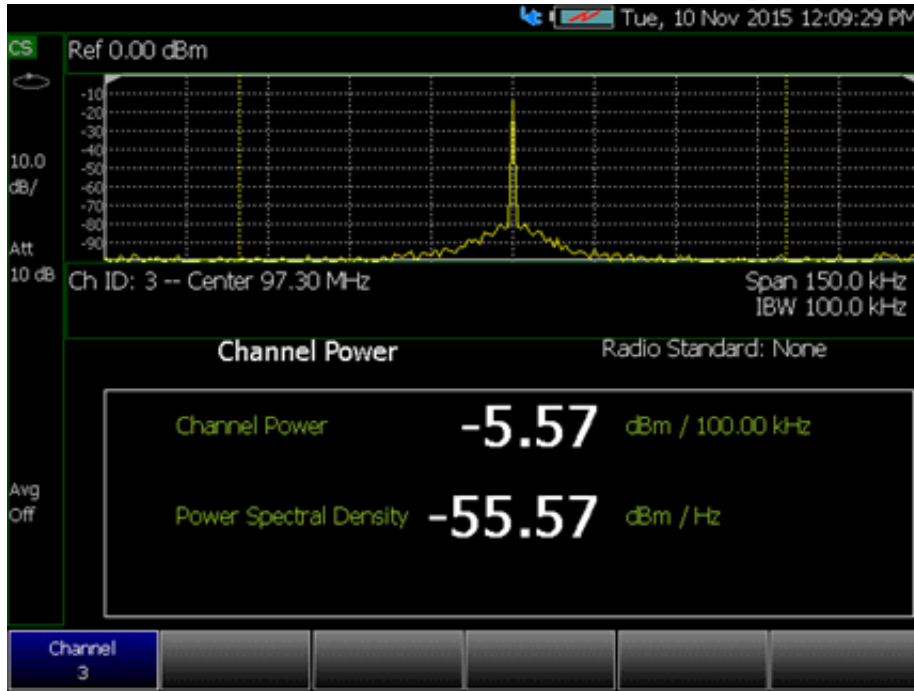

Figure 22-8 Strip Chart Display Type



Figure 22-9 Strip Chart Overlay Display Type

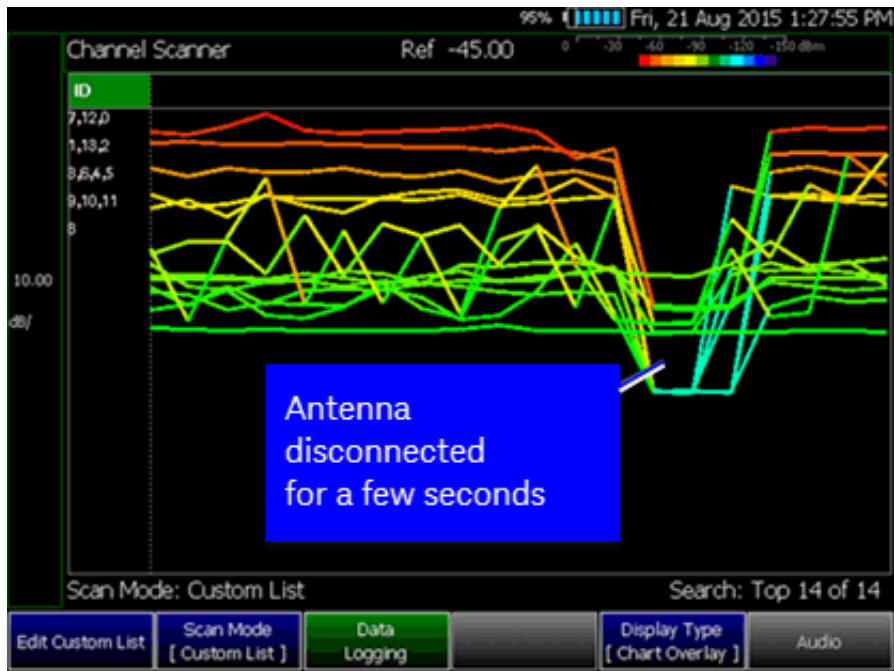
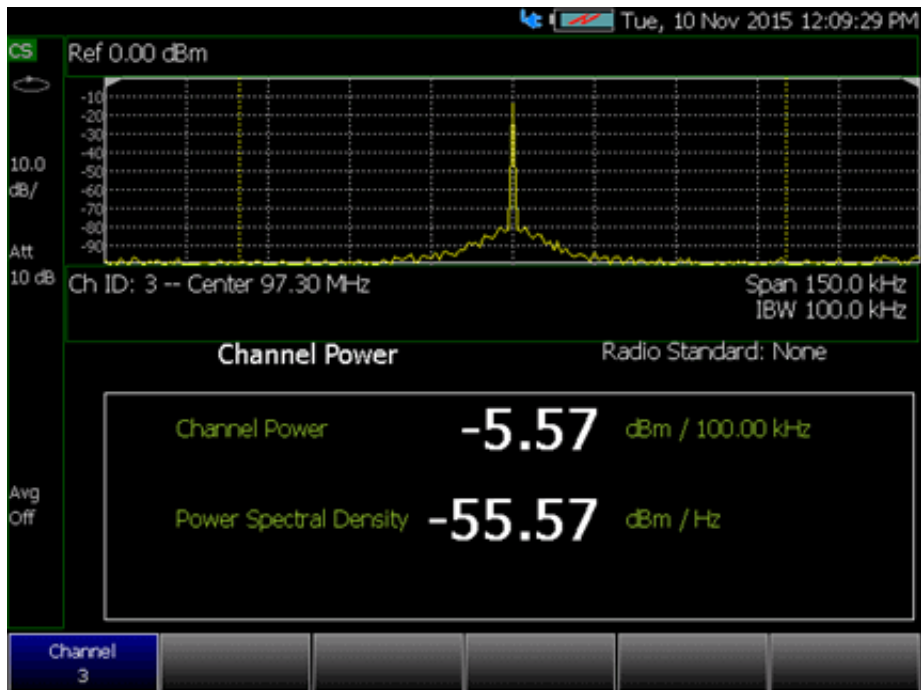

Figure 22-10 Scan & Listen Display Type



Step 3. Modify Scale and the Display Color Bar Settings

To assign colors to low and high power values:

1. Press **Scale/Amptd** > **Red Limit** to set high power values and to set the color.
2. Press **Blue Limit** to set low power values and to set the color.
3. And, then press **System** > **Display** > **Display Colors**, to set Indoor, Outdoor, or other display colors. See also [Chapter 22, "Channel Scanner \(Option 312\)", on page 371](#).

Figure 22-11 Outdoor Display Colors

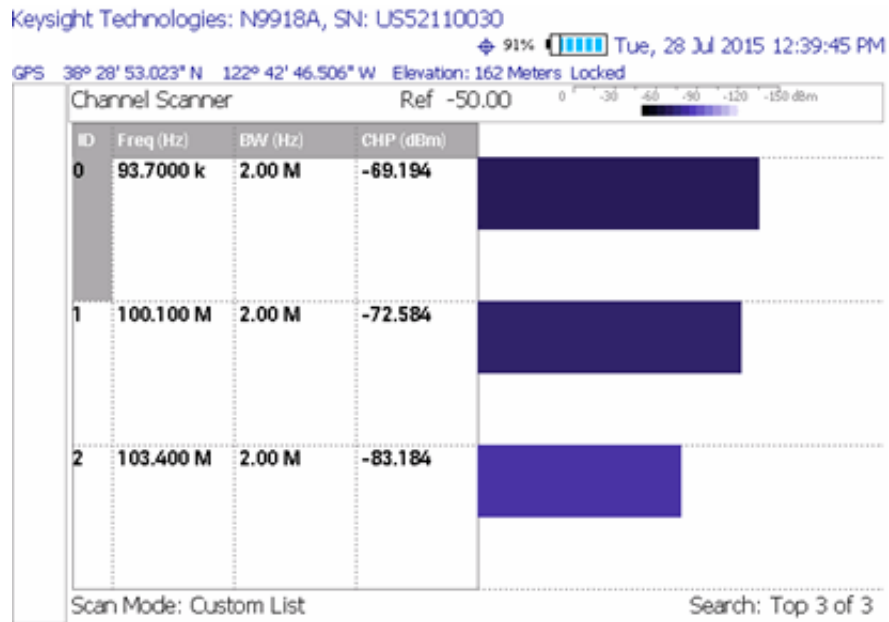
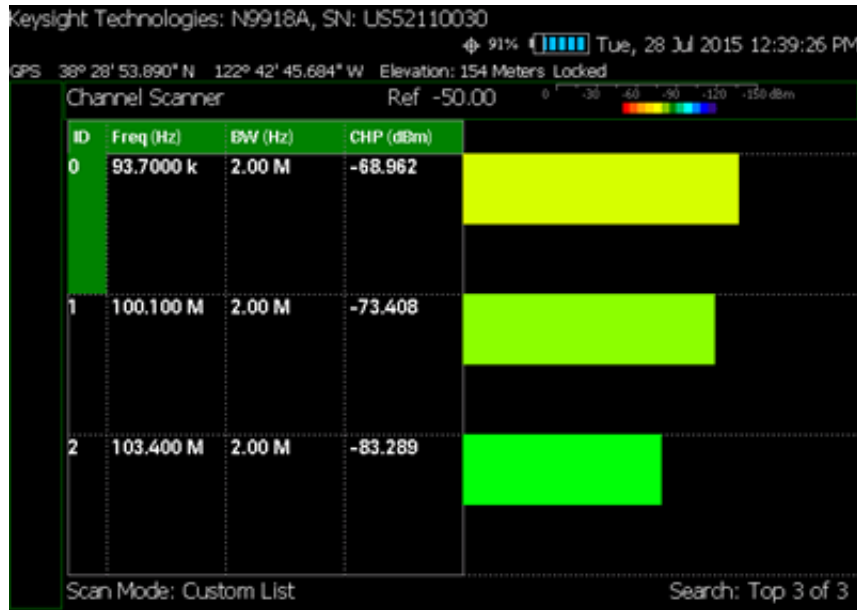

Figure 22-12 Indoor Display Colors



Step 4: Enable Data Logging and Record Results

Data logging records your data with a timestamp and GPS stamp (refer to [“GPS” on page 475](#)). GPS must be enabled for the log results to include a GPS stamp.

Features

- Log files contain measured channel results including timestamps and/or distance stamps.
 - Timestamps are included in log files with or without GPS.
 - GPS must be enabled for log results to include distance stamps.
- Data results can be logged
- Data results can be saved to a *.CSV or *.KML file. Refer to [“Save 5: Save the Log Results:” on page 384](#).
- User specifies how often results are stored.
 - Time: Store results every “n” seconds
 - Distance: Store results every “n” meters. GPS must be enabled to store results by distance.

Procedure

1. Press **Measure** > **Data Logging** > **Record Settings** > **Meas Interval ON** (default)
2. Press **Interval Type** > **Time** or **Distance** then:

- **Time Interval** 1 sec to 3,000 seconds or
 - **Distance Interval** from 1m to 10 km
 - When done, press **Back**
3. Press **Save Recall Rec-Playback** > **File Type** CSV or KLM
 4. To begin recording: Press **Record**
If Auto Save is On (default) Measurements are stored automatically accorded to the specified time or distance interval values. Refer to step 5.
 5. Optional: **Auto Save** ON (default)—When Auto Save is on, during recording, the FieldFox stores intermediate results in a temporary file. If the power fails during recording you can retrieve the results. Select **Recall Log File**. Select the temporary file name.
Press **Record Settings** > **Auto Save On Off**
 6. When done press **Stop** or **Esc**. The files save dialog is displayed. Edit the file name where the file results will be stored.
 7. Press **Done**
 8. Press **Back**

Playing a Recorded Log and Viewing the Spectrogram

To play the log results:

1. Press **Data Logging** > **Play**
2. Then choose:
 - Optional: Use the RPG (fine adjust) or the arrow keys (coarse adjust) to change the color bar.
 - **Position** to change the position along the time record's results. Recording must be Paused to use Position.
 - **Red Limit** to change the color bar.
 - **Blue Limit** to change the color bar.
3. Press **Stop** or **Esc** to exit the log recording.

To pause the log play:

1. Optional: Press **Pause Resume** to pause or resume the log recording.
2. Then choose:
 - Optional: Use the RPG (fine adjust) or the arrow keys (coarse adjust) to change the color bar.
 - **Position** to change the position along the time record's results.
 - **Red Limit** to change the color bar.

- **Blue Limit** to change the color bar.

3. Press **Stop** or **Esc** to stop the log recording.

To View the spectrogram of recorded results:

1. Press **View**

2. Then choose:

- **Zoom** to zoom in on spectrogram time record results.
- **Red Limit** to change the color bar.
- **Blue Limit** to change the color bar.

3. Press **Exit** or **Esc** to exit view.

Save 5: Save the Log Results:

Two file types are supported for save or recall log results:

- KML file format
 - Files include bar color
 - Files stored in this format can be imported into 3rd party applications like Google Earth or Google Maps.
- CSV file format. Files stored into this format can be imported into spreadsheet applications.

1. Press **Save Recall Rec-Playback** > **File Type** CSV or KLM > **Back**

2. To begin recording: Press **Record**

Measurements are stored automatically according to the specified time or distance interval values.

3. When done press **Stop**. The files save dialog is displayed. Edit the file name where the file results will be stored.

4. Press **Done**

5. Optional: **Auto Save** ON (default)—When Auto Save is on, during recording, the FieldFox stores intermediate results in a temporary file. If the power fails during recording you can retrieve the results. Select **Recall Log File**. Select the temporary file name.

Press **Record Settings** > **Auto Save On Off**

Step 6: Import and Play back KML Files into 3rd Party Software (Example: Google Earth with Animation Tool)

Features

Use the Playback Slider to replay measurement results. See also Google Maps and or Google Earth's help.

Channel Scanner (Option 312) How to Set Up Channel Scanner

- Open the FieldFox *.KML file in Google Earth. Time Slider appears in upper left of the map.
- Manual Mode – Move the time slider cursor to see color-coded icons pop-up according to the timestamp.
- Loop mode has a Fast-Slow Replay Option.
- Click on each color coded balloon to see the table of measurement results for that location.

Figure 22-13 Importing a KML File Into Google Earth

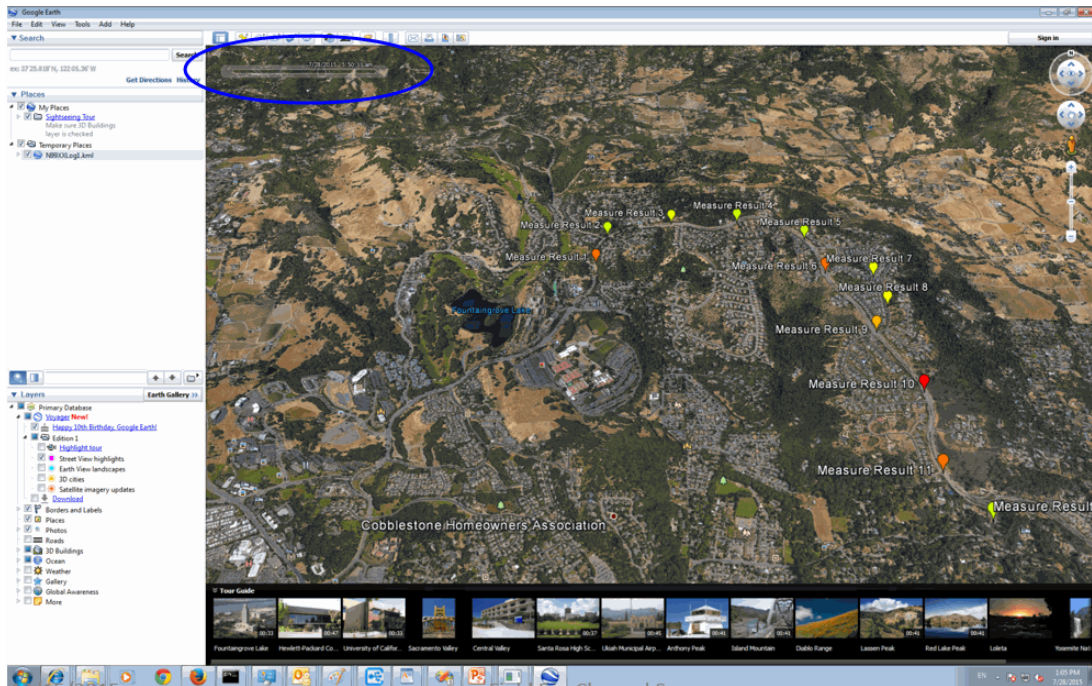

Channel Scanner (Option 312)
How to Set Up Channel Scanner

23 Noise Figure Mode (Option 356 – CPU2 Only)

NOTE

Noise figure requires these options:

- Spectrum analyzer mode (Option 233–Combination Analyzers Only)
- Preamplifier (Option 235)
- DC variable voltage source (Option 309)
- Noise source (Refer to <https://literature.cdn.keysight.com/litweb/pdf/5990-9783EN.pdf>)

Not required, but recommended for improved accuracy:

- External preamplifier (U7227A/C/F and U7228A/C/F). Refer to www.keysight.com/find/usb-preamp.
-

Figure 23-1

Example of Jitter Uncertainty (21 points)—with Uncertainty Bars. Learn more in [“How to use Auto-Integration”](#) on page 428.

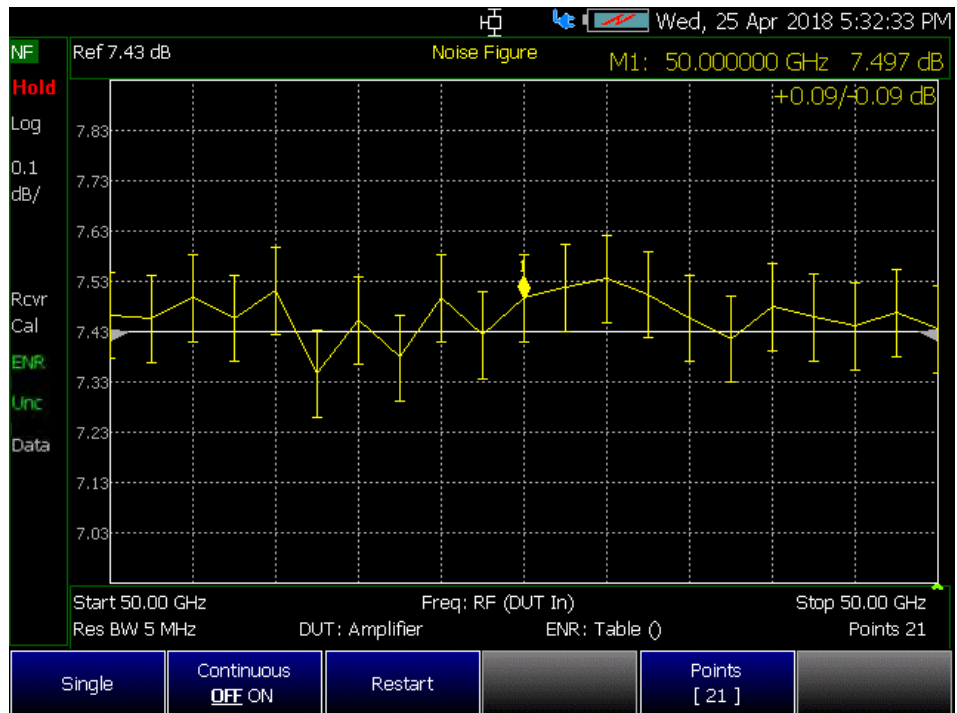
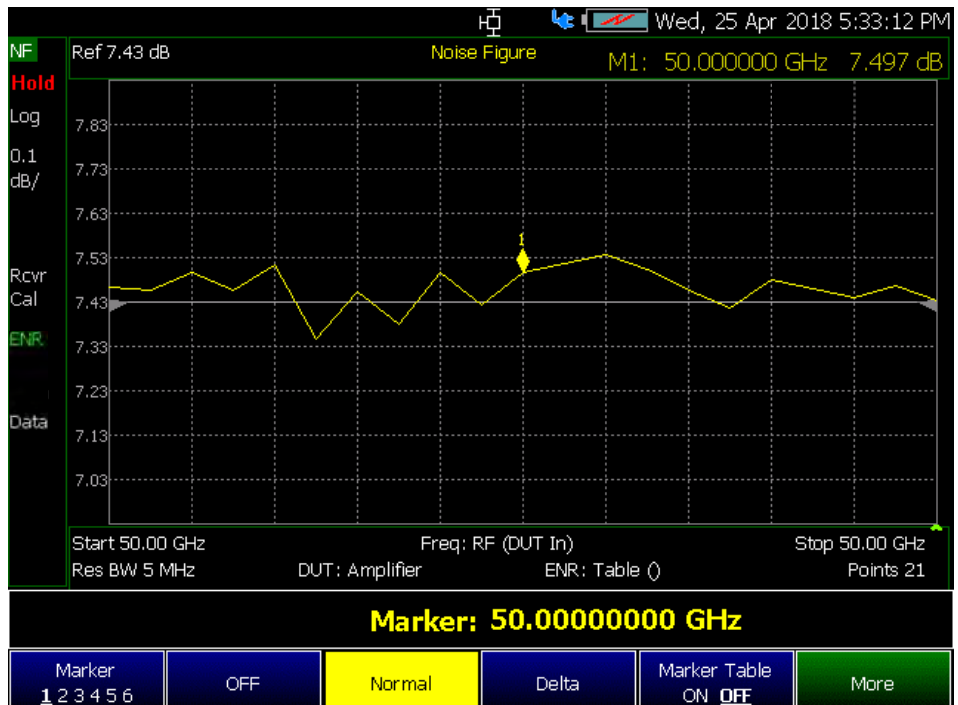

Figure 23-2

Example of Jitter Uncertainty (21 points)—with Uncertainty Bars Disabled. Learn more in [“How to use Auto-Integration”](#) on page 428.



In this Chapter:

- “Using Noise Figure” on page 390
- “How to Define a Noise Figure Measurement” on page 394
 - “Example: Typical Noise Figure Measurement Procedure” on page 394
 - “Overview of Softkey Menus” on page 395
 - “How to Use DUT Measurement Setups” on page 402
 - “Single / Continuous / Restart” on page 414
 - “Points ” on page 414
 - “Alignments” on page 415
 - “Calculating Noise Figure Measurement Uncertainty” on page 416
 - “Using ENR Tables” on page 421
 - “About ENR (*.enr), Preamplifier (*.amp), and DUT (*.dut) Files” on page 422
 - “Using Markers (Noise Figure)” on page 424
- “Calibration Wizard” on page 425
- “How to use Auto-Integration” on page 428
- “Other Features Available” on page 434
- “Troubleshooting” on page 435

See Also

- “All about Markers” on page 438
- “All about Limit Lines” on page 453
- “All about Trace Math” on page 458
- “All about Scale Settings” on page 460
- Chapter 24, “Data Analysis Features.”
- Chapter 27, “File Management.”

Using Noise Figure

Noise Figure enables you to do the following:

The FieldFox uses the Y-Factor technique to accurately verify and characterize the noise figure of devices. Option 356 has these features:

Five Measurement Types

- Noise Figure
- Noise Temperature
- Noise Factor
- Y-Factor
- Gain

Four Measurement Setup Types

- Noise Source
- Integration
- DUT
- Uncertainty

Four Pre-configured DUT Measurement Types

- Amplifier
- Upconverter
- Downconverter
- Multi-Stage Converter

Uncertainty Contribution Values can be Customized for Your Device

- Jitter uncertainty
- Mismatch uncertainty
- ENR uncertainty
- User calibration uncertainty
- Uncertainty bars

Select Noise Figure Mode before making any setting in this chapter.

How to select Noise Figure Mode:

- Press **Mode**.
- Then **More**.
- Then **Noise Figure**.

Noise Figure Mode (Option 356 – CPU2 Only)
Using Noise Figure

Figure 23-3 Display Annotation—Overview

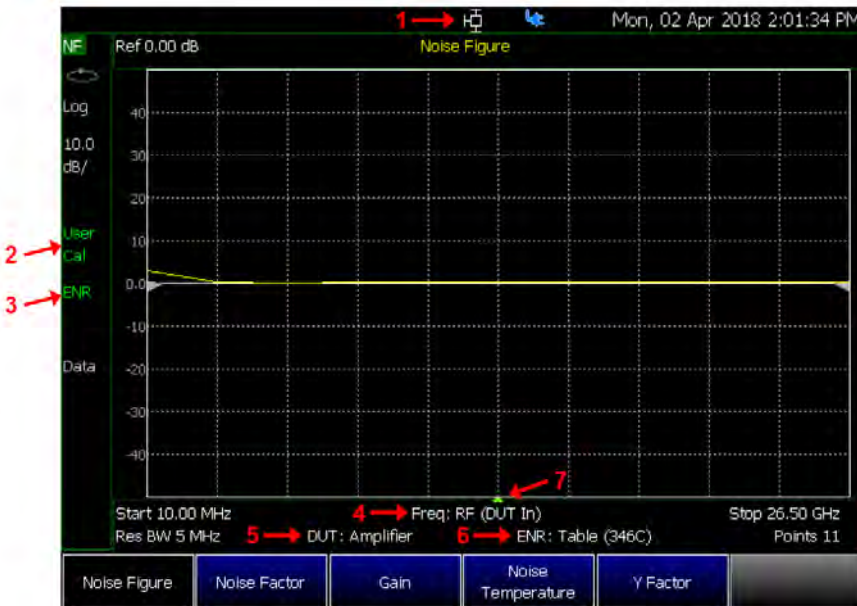

1. Variable Voltage Source (VVS) Status (appears when VVS is on. Refer to “[Variable Voltage Source \(Opt. 309\)](#)” on page 485.
2. Calibration Status
3. Excess Noise Ratio (ENR) Status
4. Frequency Context
5. DUT Type
6. Excess Noise Ratio (ENR) Mode
7. Sweep point caret (shows last point measured)

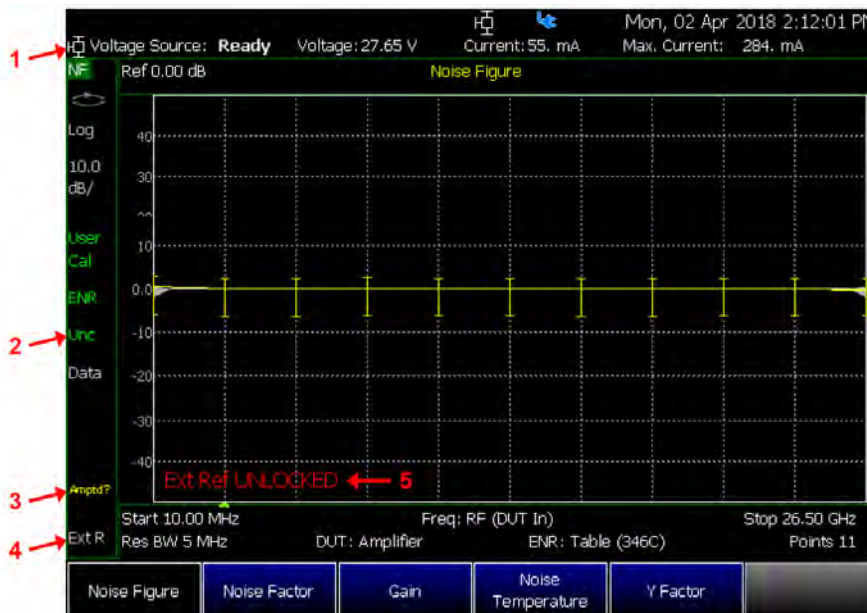

1. Variable Voltage Source (VVS) Status line (appears when the VVS status line is turned on in the system menu). Refer to “[Variable Voltage Source \(Opt. 309\)](#)” on page 485.
2. Uncertainty status annotation (displayed when the uncertainty bars are enabled)
3. Questionable Amplitude annotation (displayed when the Amplitude Alignment is stale)
4. External Reference annotation (displayed when external reference is selected)
5. Warning message annotation. Used to display the following warnings:
 - Invalid frequency settings
 - VVS trip
 - ADC Over Range
 - Ext Ref unlock

Figure 23-4 Dual Window Display Annotation

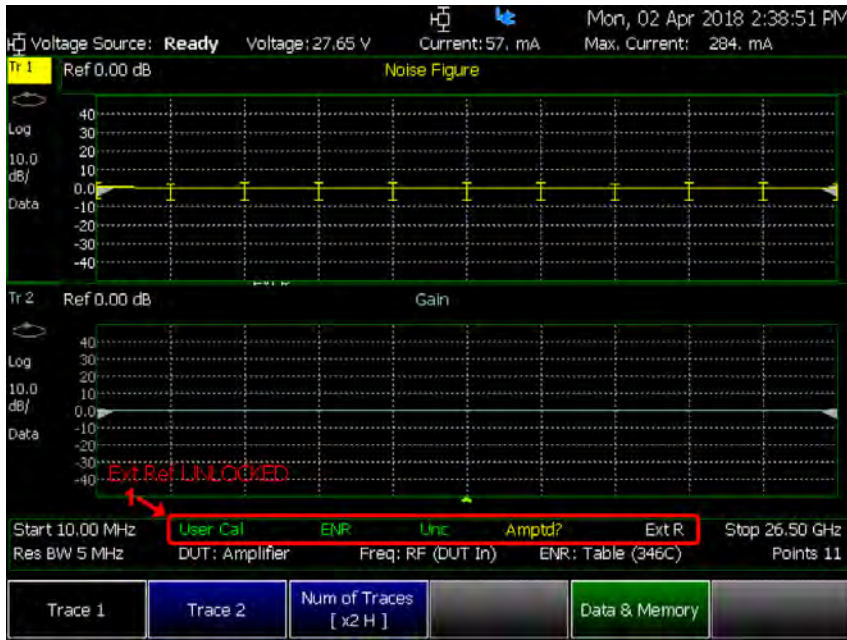

1. In the dual-window layout, non-trace-specific annotations are moved from the left of the traces to the bottom of the traces

Figure 23-5 Calibration Annotation

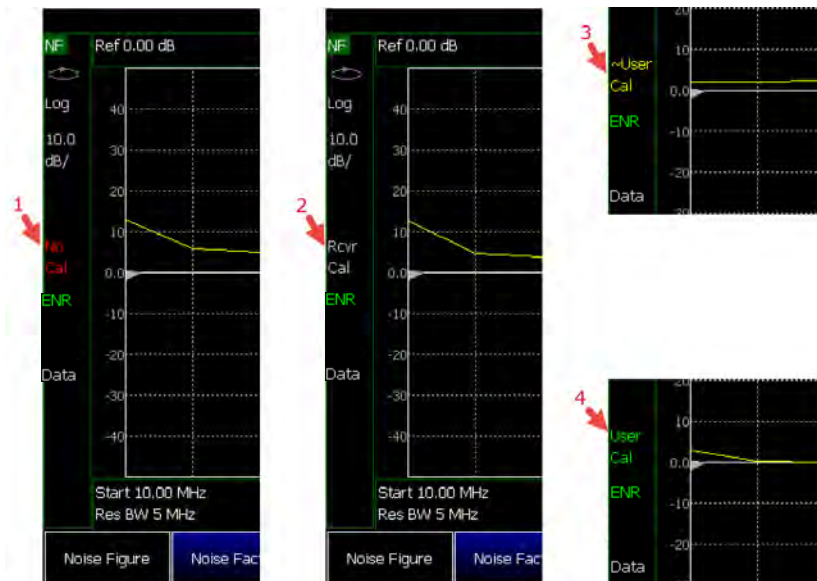

1. No Cal = No calibration applied
2. Rcvr Cal = Only receiver calibration applied
3. ~User Cal = Receiver Cal + User Cal applied, but User Cal is interpolated (the calibration frequency points do not match up with sweep frequency points)
4. User Cal = Receiver cal + User Cal applied and User Cal is not interpolated (the calibration frequency points match up with sweep frequency points)

Figure 23-6 ENR Status and Mode Annotation

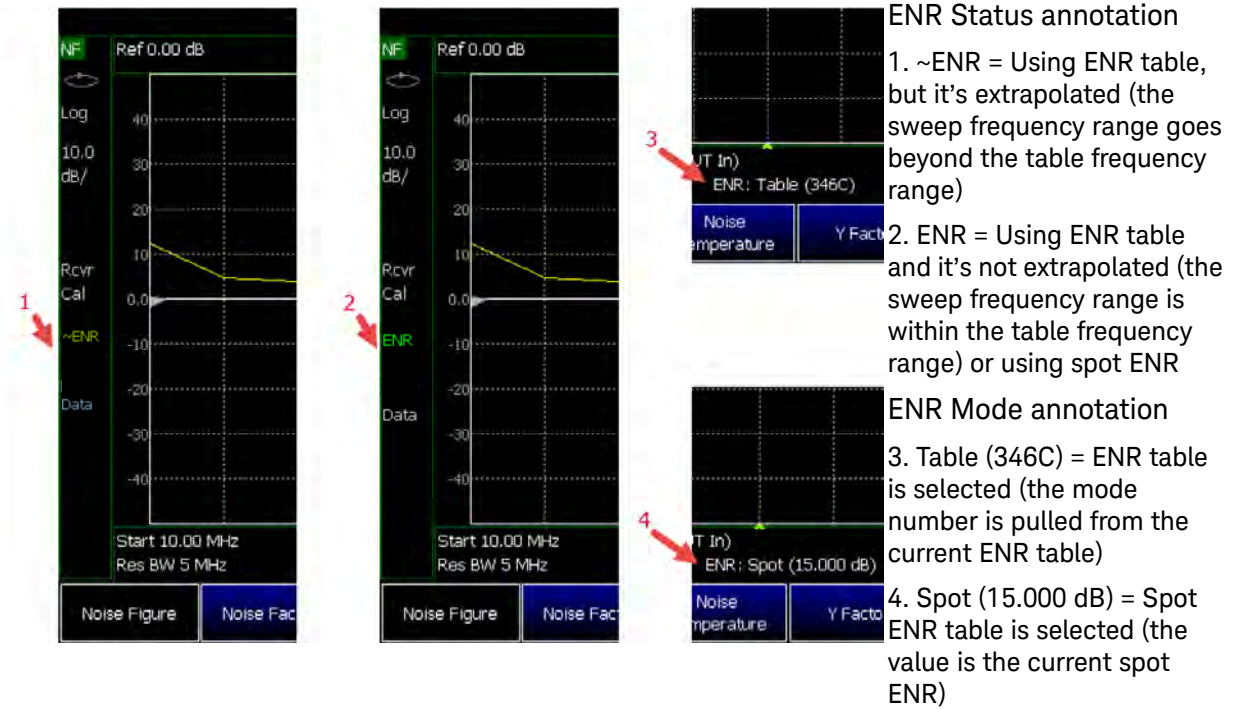
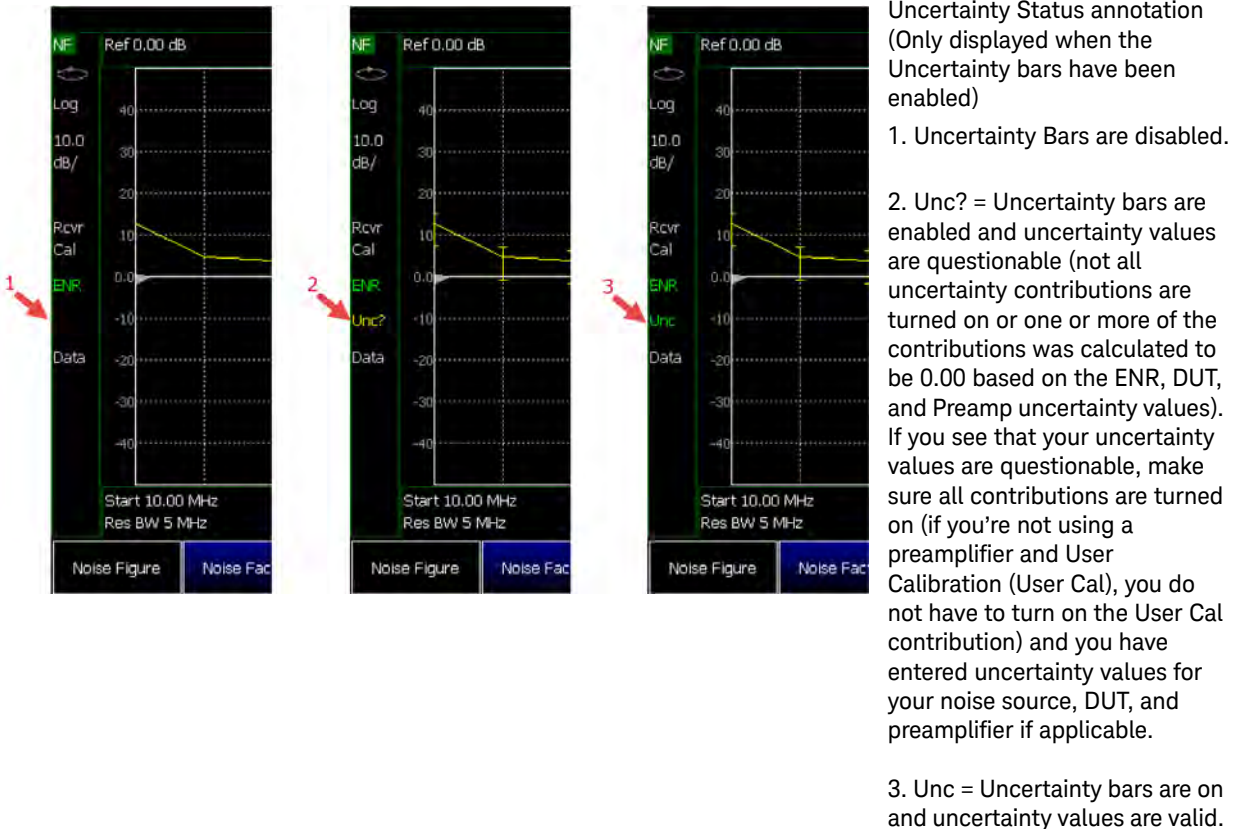

Figure 23-7 Uncertainty Annotation



How to Define a Noise Figure Measurement

The Option 356 Noise Figure mode uses the Y-factor method to calculate the noise figure.

This section contains the following:

- “[Example: Typical Noise Figure Measurement Procedure](#)” on page 394
- “[Overview of Softkey Menus](#)” on page 395
- “[How to Use DUT Measurement Setups](#)” on page 402
- “[Single / Continuous / Restart](#)” on page 414
- “[Points](#)” on page 414
- “[Resolution Bandwidth \(Res BW\)](#)” on page 415
- “[Alignments](#)” on page 415
- “[Calculating Noise Figure Measurement Uncertainty](#)” on page 416
- “[Using ENR Tables](#)” on page 421
- “[Using Markers \(Noise Figure\)](#)” on page 424

Example: Typical Noise Figure Measurement Procedure

This section briefly reviews the steps in setting up a noise figure measurement. If you are not familiar with this process or would like more information, refer to “[Overview of Softkey Menus](#)” on page 395 and “[How to Use DUT Measurement Setups](#)” on page 402.

1. Set up a Noise Source ENR Table:
(**Meas Setup** > **Noise Source** > **ENR Table Edit/Save/Recall**).
2. Set the resolution bandwidth: **BW** > **Res BW**
3. Set the frequency range: **Freq/Dist** >
 - **Start**,
 - **Stop**,
 - **Center**, and
 - **Span**
4. Set the number of points: **Sweep** > **Points** (minimum = 3 points, maximum = 1001 points, default = 21)
5. Use **Meas Setup** > **Integration** Setup Integration (See also “[How to use Auto-Integration](#)” on page 428.)
 - **Max. Time/Pt.** (Available when Mode = Auto) or
 - **Time/Pt.** (available when Mode = Fixed)

6. Perform a Receiver Calibration: (**Cal** > **Run Receiver Cal** and follow prompts).
7. Enter DUT setup type: **Meas Setup** > **DUT** > **Type**
 - **Amplifier** (default),
 - **Downconverter**,
 - **Upconverter**, or
 - **Multi-Stage Converter**
8. Run a User Calibration (i.e., If you are using an external preamp). (**Cal** > **Run User Cal** and follow prompts).
9. Use **Measure** to select the type of noise figure measurement:
 - **Noise Figure**,
 - **Noise Factor**,
 - **Gain**,
 - **Noise Temperature**, or
 - **Y-Factor**
10. Use **Meas Setup** > **Uncertainty** > **Uncert Contributions** to Enable/Disable Uncertainty Contributions:
 - **Jitter Uncert OFF ON**,
 - **ENR Uncert OFF ON**,
 - **Mismatch Uncert OFF ON**,
 - **User Cal Uncert OFF ON** (applies the current User Cal uncertainty to the current measurement's uncertainty calculations), and
 - Then **Back** > **Uncert Bars** to **ON**.

Overview of Softkey Menus

This sections describes the Noise Figure's Measure, Measure Setup softkeys, and related sub-menu softkeys.

1. Define a measurement type.
 - a. Select a **Measure**—choose:
 - **Noise Figure** Specify Noise Figure (default) or

NOTE

Noise Figure has asymmetrical uncertainty (i.e., log measurement). Noise Factor and Noise Temperature have symmetrical uncertainty (i.e., linear measurement). Uncertainty is not displayed for Gain and Y-Factor.

-
- **Noise Factor** Specify a Noise Factor or

- **Gain** Specify Gain or
- **Noise Temperature** Specify Noise Temperature or
- **YFactor** Specify Y-Factor

b. Then modify the settings based on the selected noise figure type

2. Select **Measure Setup**—choose:

- **Noise Source** or “**DUT** or” on page 398, “**Integration** or” on page 399, or “**Uncertainty**” on page 399.

Opens a menu of softkeys to define the Noise Figure’s ENR Mode Spot or Table and uncertainty values.

Then choose:

- **ENR Mode Spot Table** You can enter ENR data for the noise source you are using as a table of values or as a single spot value. The values held in the table can be used for measurements at a range of frequencies as well as at a fixed frequency.

The single spot value is used either for measurements at a single frequency, or for measurements across a range of frequencies that is narrow enough such that the ENR value does not change significantly across that range. (Default is Table).

- **ENR Spot Values** Opens a menu to enter a spot value either for measurements at a single frequency or for measurements across a range of frequencies that is narrow enough such that the ENR value does not change significantly across that range (Inactive with ENR Mode set to Table).

Then choose:

- **ENR** sets the ENR spot value in dB (default is 15 dB).
- **ENR Uncert.** sets the ENR spot uncertainty value in dB (default is 0.000 dB).
- **On | Γ** sets the On value (hot) of the ENR spot value’s 50 Ω match, Γ (0.000 to 1.000).
- **Off | Γ** sets the Off value (cold) of the ENR spot value’s 50 Ω match, Γ (0.000 to 1.000).
- **ENR Uncert. Cov. | 2σ** Opens a menu to set the value of the ENR uncertainty coverage.

Then choose: **1 σ** , **2 σ** (default), or **3 σ** .

- **More** opens additional ENR Spot Value softkey menu choices
- **Γ Spec. Style [95th %ile]** Opens a menu of softkeys to set the Γ specification style.
Then choose **Maximum**, **95th %ile** (default), **80th %ile**, **Median**, **Mean**, or **Fixed**.
- **Γ Distribution [Rayleigh]** Opens a menu of softkeys to set the type of Γ distribution.
Then select **Rayleigh** (default), **Fixed**, or **Uniform in Circle**.
- **ENR Table Edit/Save/Recall** Opens the ENR table menu to edit, save, or recall noise source values (Not active with ENR Mode set to Spot).

Then choose:

- **Edit ENR Table** Opens the currently selected table of noise source values (generic default noise source values are populated for quick check). Enter your noise source's values for more accurate measurements.

CAUTION

IMPORTANT! Save your noise source table with a unique filename to avoid loss of table data. All noise figure files are saved with *.enr type suffixes.

- **New ENR Table** opens a new ENR table for entering and saving additional noise source values.

CAUTION

The FieldFox displays *Replace existing file?*, because the displayed default filename is the one last saved. Enter a unique filename to avoid loss of table data (i.e., all noise figure files are saved with *.enr type suffixes).

- **Save ENR Table** Opens a menu of softkeys to enable you to enter a unique noise source filename.
- **Recall ENR Table** Opens a menu of file recall softkeys and displays a list of stored noise source files.
- **Storage Device [Internal]** Opens a menu of softkeys to set the storage location for your files.
Then choose **Internal** (default), **SD Card**, or **USB**.
- **Back** to return to previous menu.

Noise Figure Mode (Option 356 – CPU2 Only)
How to Define a Noise Figure Measurement

- **T Cold Default** When making measurements at different ambient temperatures, you can set the T_{cold} value in Kelvin (K) manually (User). When set to Default, the T_{cold} value is set to the 296.5 K (Default = Default).
 - **Back** to return to previous menu.
-
- **DUT** or
Opens a menu of softkeys to define your DUT Type (Amplifier, Downconverter, Upconverter, or Multi-Stage Converter), frequency context, and loss compensation. Refer to **“How to Use DUT Measurement Setups”** on page 402.

– **Integration** or

Opens a menu of softkeys to define the Integration's Mode Auto or Fixed and Jitter values.

CAUTION

For optimum speed and performance measurement results, it is recommended that auto-integration is used in all noise figure measurements.

Then choose:

- **Mode Auto Fixed** Select Auto (default) to let the FieldFox select the optimum coupled instrument settings. Changes can be made to the Jitter Goal and Max Time/Pt. values. When integration Mode is set to Fixed, the Time/Pt. softkey is active and can be modified.
- **Jitter Goal** Sets the maximum peak-to-peak jitter value. Values greater than this value triggers the Jitter Warning (i.e., if Jitter Warning = ON). (Only active when Mode = Auto.) (Default is 0.5 dB.)
- **Max Time/Pt.** Sets the maximum amount of time the jitter is measured at a given point to attempt to reach the Jitter Goal value (i.e., the measurement time per point is automatically adjusted to the minimum time required, but will never exceed the displayed Max Time/Pt.). After this time, values in excess of the jitter Goal value trigger the Jitter Warning.
- **Jitter Warning** Enables/Disables the Jitter Warning. The Jitter Warning displays when the Jitter value exceeds the Jitter Goal value. (Default = ON.)
- **Time/Pt.** Sets the Time/Pt. when Mode is set to Fixed. (Only active when Mode = Fixed.)
- **Back** to return to previous menu.

– **Uncertainty**

Opens a menu of uncertainty softkeys for setting the DUT, Preamp, and Uncert. Contributions.

Then choose:

- **DUT** Sets the DUT Mode to either Spot (default) or Table.

Then choose:

- **DUT Mode** Set to Spot (default) or to Table

For DUT MODE Spot choose:

- **DUT Spot Values** (Only active when DUT Mode = Spot).
Then choose:
 - **Input Γ** Sets the input Γ value.
 - **Output Γ** Sets the output Γ value.
 - **Γ Spec. Style [Fixed]** Opens a menu of softkeys to set the Γ specification style.
Then choose **Maximum**, **95th %ile**, **30th %ile**, **Median**, **Mean**, or **Fixed** (default).
 - **Γ Distribution [Fixed]** Opens a menu of softkeys to set the type of Γ distribution.
Then select **Rayleigh**, **Fixed** (default), or **Uniform in Circle**.
 - **Back** to return to previous menu.

- **DUT Table Edit/Save/Recall** (Only active when DUT Mode = Table).
Then choose:
 - **Import DUT Data** Opens a menu of softkeys where you can select a DUT *.csv or *.snp data file to import into your table.
Then choose **Recall File**, **Sort by File Name**, **Sort by Date**, **Next Page**, **Previous Page**, or **Cancel**.
 - **Edit DUT Data** Opens a menu of softkeys where you can edit the current selected DUT table data file (e.g., serial number, model number, Γ Spec. Style, Γ Distribution, Input Γ , Output Γ , and frequencies).
Then choose **Edit**, **Next Page**, **Previous Page**, **Add Row** (only active for Frequency), **Delete/Clear** (only active for Frequency), or **Done**.
 - **New DUT Table** Opens a menu of softkeys to choose a new DUT table.

CAUTION

IMPORTANT! The FieldFox displays `Replace existing file?`, because the displayed default filename is the one last saved. Enter a unique filename to avoid loss of table data.

- **Save DUT Table** Opens a Create a filename menu of softkeys to enter a DUT table filename and then to save the file.
- **Recall DUT Table** Opens a Select a file menu of softkeys to enter a DUT table filename to recall.
- **Storage Device [Internal]** Opens a set of softkeys to select where your DUT table is saved.
Then choose **Internal**, **SD Card**, or **USB**.
- **Back** to return to previous menu.

- **Preamp** Sets the DUT Mode to either Spot (default) or Table.

Then choose:

- **Preamp Mode** Set to Spot (default) or to Table.
For Preamp MODE Spot choose:
 - **Preamp Spot Values** (Only active when DUT Mode = Spot).
Refer to similar "**DUT Spot Values (Only active when DUT Mode = Spot).**" on page 400.
 - **Back** to return to previous menu.
 - **Preamp Table Edit/Save/Recall** (Only active when Preamp Mode = Table).
Refer to similar "**DUT Table Edit/Save/Recall (Only active when DUT Mode = Table).**" on page 400.
 - **Back** to return to previous menu.

- **Uncert Contributions** Opens a menu of uncertainty contribution softkeys.

Then choose:

- **Jitter Uncert.** Enable/disable the Jitter Uncertainty.
- **ENR Uncert.** Enable/disable the ENR Uncertainty.
- **Mismatch Uncert.** Enable/disable the Mismatch Uncertainty.

- **User Cal Uncert.** Enable/disable the User Cal Uncertainty.
- **Back** to return to previous menu.

- **Uncert Cover** Sets the uncertainty coverage value for the current settings.
Then choose: **1 σ** , **2 σ** (default), or **3 σ** .
- **Uncert Bars** Enables/disables the uncertainty calculator uncertainty bars values for the current settings.
- **Back** to return to previous menu.

How to Use DUT Measurement Setups

Noise figure Option 356 has four predefined measurement setups:

- Amplifier
- Downconverter
- Upconverter
- Multi-Stage Converter

Refer to **“Using Measure Setup to Choose DUT Type” on page 402.**

Each of the four measurements has frequency context and loss compensation softkeys that can be used to optimize the DUT’s noise figure measurement. Refer to **“DUT Type and Frequency Context” on page 407** and to **“DUT Type Loss Compensation” on page 412.**

Using Measure Setup to Choose DUT Type

This section contains the following:

- Setting **DUT** > **Type [Amplifier]**, see **Figure 23-8 on page 403**
- Setting **DUT** > **Type [Downconverter]**, see **Figure 23-9 on page 404**
- Setting **DUT** > **Type [Upconverter]**, see **Figure 23-10 on page 405**
- Setting **DUT** > **Type [Multi-Stage Converter]**, see **Figure 23-11 on page 406**

Figure 23-8 DUT – Measurement Setup – Type [Amplifier] Screen

DUT – Measurement Setup – Type [Amplifier]

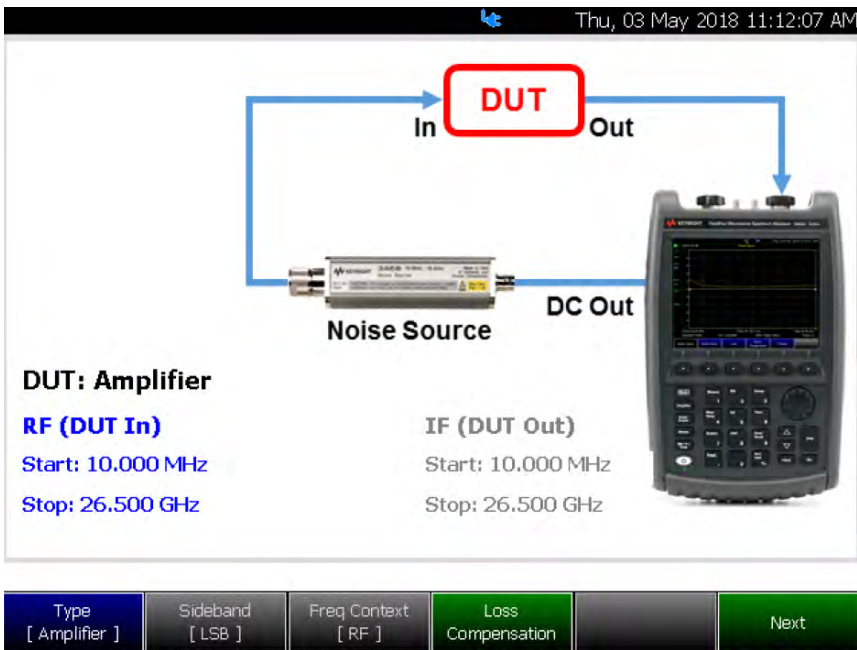

Used for setting up DUT parameters without an external preamplifier (LNA)

– Type [Amplifier]

--DUT displays does not display LO if not frequency converting

---Displays preamp (LNA), if User Cal is available. See next image this figure.

DUT – Measurement Setup – Type [Amplifier] with External Amplifier (LNA) and User Calibration

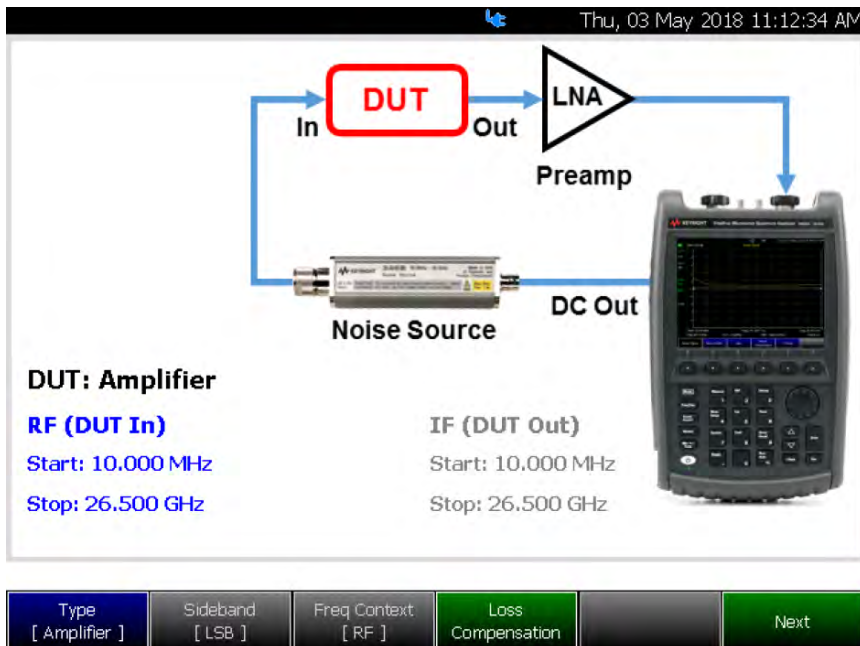

Used for setting up DUT parameters with an external preamplifier (LNA)

Figure 23-9 DUT Measurement Setup – Type [Downconverter] Screen

DUT – Measurement Setup – Type [Downconverter]

DUT: Downconverter (LSB)

RF (DUT In)	LO	IF (DUT Out)
Start: 9.000 GHz	10.000 GHz	Start: 1.000 GHz
Stop: 8.000 GHz		Stop: 2.000 GHz

Navigation: Type [Downconverter], Sideband [LSB], Freq Context [IF], Loss Compensation, Next

Used for setting up DUT parameters without an external preamp

- Type [Downconverter]
- Performs internal frequency downconversion (converts RF down to IF)
- Sideband:
 - LSB: Lower Sideband (available for downconverter and upconverter)
 - USB: Upper Sideband (available for downconverter and upconverter)
 - DSB: Double Sideband (available for downconverter; averages LSB and USB ENR values)

DUT – Measurement Setup – Type [Downconverter] with External Amplifier (LNA) and User Calibration

DUT: Downconverter (LSB)

RF (DUT In)	LO	IF (DUT Out)
Start: 9.000 GHz	10.000 GHz	Start: 1.000 GHz
Stop: 8.000 GHz		Stop: 2.000 GHz

Navigation: Type [Downconverter], Sideband [LSB], Freq Context [IF], Loss Compensation, Next

Used for setting up DUT parameters with an external preamp

Figure 23-10 DUT Measurement Setup – Type [Upconverter] Screen

DUT – Measurement Setup – Type [Upconverter]

DUT: Upconverter (LSB)

RF (DUT In)	LO	IF (DUT Out)
Start: 9.000 GHz	10.000 GHz	Start: 1.000 GHz
Stop: 8.000 GHz		Stop: 2.000 GHz

Buttons: Type [Upconverter], Sideband [LSB], Freq Context [IF], Loss Compensation, Next

Used for setting up DUT parameters without an external preamp

–Type [Upconverter]

--Performs internal frequency upconversion (technically, converts IF up to RF, but for this case RF always = DUT In and IF always = DUT Out and so, converts RF up to IF)

–Sideband

--LSB: Lower Sideband (available for downconverter and upconverter)

--USB: Upper Sideband (available for downconverter and upconverter)

DUT – Measurement Setup – Type [Upconverter] with External Amplifier (LNA) and User Calibration

DUT: Upconverter (LSB)

RF (DUT In)	LO	IF (DUT Out)
Start: 9.000 GHz	10.000 GHz	Start: 1.000 GHz
Stop: 8.000 GHz		Stop: 2.000 GHz

Buttons: Type [Upconverter], Sideband [LSB], Freq Context [IF], Loss Compensation, Next

Used for setting up DUT parameters with an external preamp

Figure 23-11 DUT Measurement Setup – Type [Multi-Stage Converter] Screen

DUT – Measurement Setup – Type [Multi-Stage Converter]

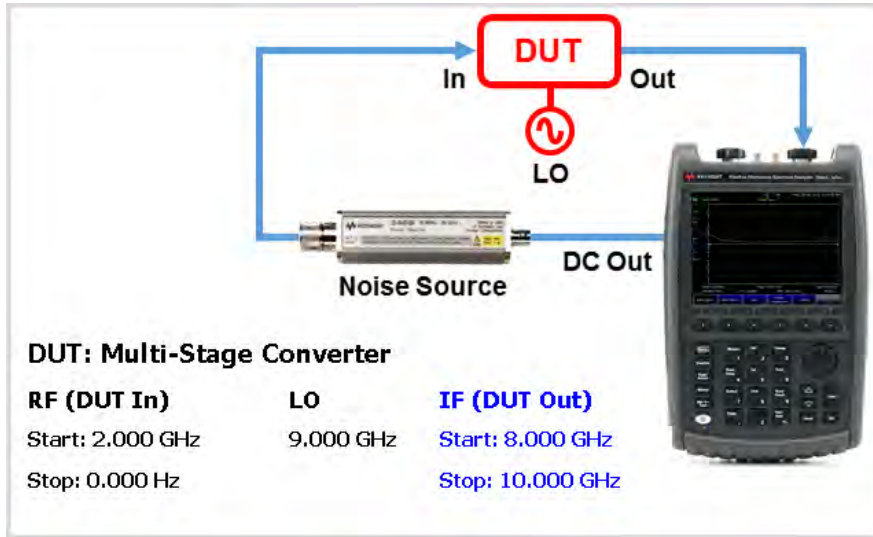

Used for setting up DUT parameters
 – Type [Multi-Stage Converter]
 --Multi-Stage Converter: Performs multi-stage frequency conversion (converts RF down/up to IF)



DUT – Measurement Setup – Type [Multi-Stage Converter] with External Preamp (LNA) and User Calibration

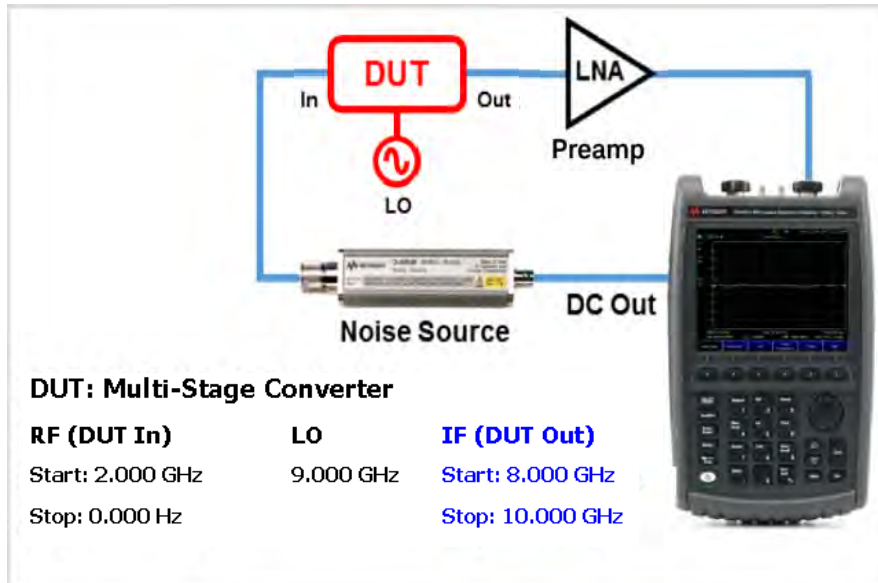

Used for setting up DUT parameters with preamp and User Cal

DUT Type and Frequency Context

Noise figure enables you to define the frequency context for your noise figure measurements:

- RF (DUT In):
 - Start
 - Stop
 - Center
 - Span
- Freq Context—(Inactive for Amplifier):
 - RF
 - IF
- LO—(Inactive for Amplifier)
- IF (DUT Out)—(Inactive for Amplifier)
 - Start
 - Stop
 - Center
 - Span

This section contains the following:

- Setting **Meas Setup** > **DUT** > **Next** > **RF (OUT in)**, see [Figure 23-12 on page 408](#)
- Setting **Meas Setup** > **DUT** > **Next** > **IF (DUT Out)**, see [Figure 23-13 on page 409](#)
- Setting **Meas Setup** > **DUT** > **Freq Context [IF]**, see [Figure 23-14 on page 410](#)

Frequency Context – RF (DUT In)

The RF (DUT In) softkey can be used to define the DUT Type’s RF Start, Stop, Center, and Span frequencies. Refer to “[Frequency Range and Frequency Context](#)” on page 411.

Figure 23-12 DUT >Type [Amplifier] and [Multi-Stage Converter] > RF (DUT In)–Frequency Context

DUT – Measurement Setup – Type [Amplifier] and [Multi-Stage Converter]

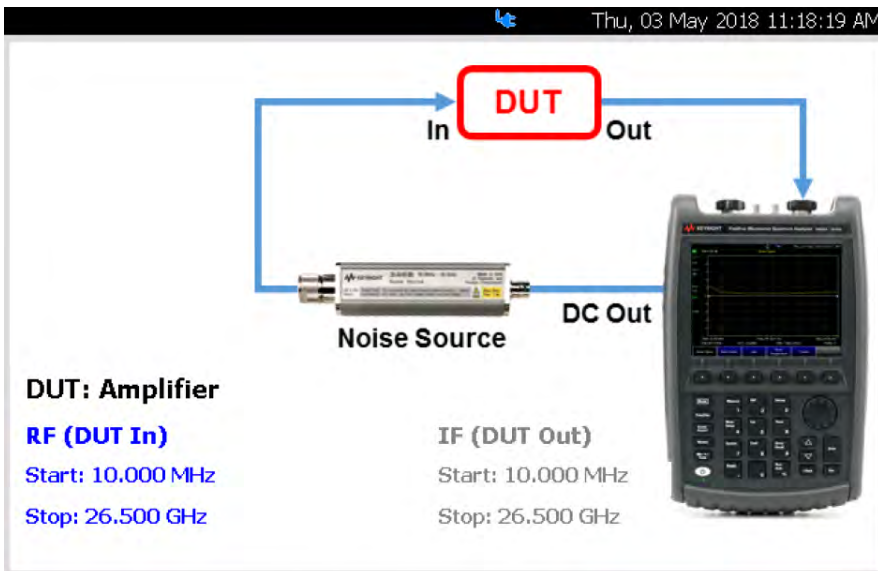

Used for setting up Start, Stop, Center, and Span frequency context for a DUT

– Type [Amplifier] and [Multi-Stage Converter]



--Set the frequency context based on the DUT Type



--Enter the RF (DUT In) values for Start, Stop, Center, and Span frequencies

Frequency Context – IF (DUT Out) – Inactive for Type [Amplifier]

The IF (DUT Out) softkey can be used to define the DUT Type’s IF Start, Stop, Center, and Span frequencies. Refer to “[Frequency Range and Frequency Context](#)” on page 411.

Figure 23-13 DUT >Type [Downconverter], [Upconverter], and [Multi-Stage Converter] > IF (DUT Out)–Frequency Context (Inactive for Type [Amplifier])

DUT – Measurement Setup – Type [Downconverter], [Upconverter], and [Multi-Stage Converter]

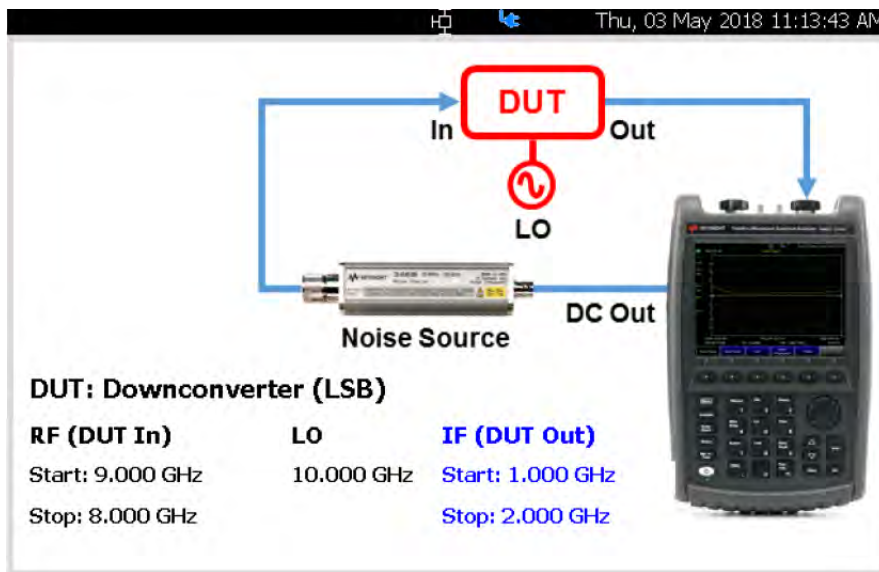

Used for setting up Start, Stop, Center, and Span frequency context for a DUT

– Type [Downconverter], [Upconverter], and [Multi-Stage Converter]



--Set the frequency context based on the DUT Type



--Enter the RF (DUT In) values for Start, Stop, Center, and Span frequencies

DUT Type–Freq Context (IF or RF)–(Inactive for DUT Type [Amplifier])

Frequency context can be used to define the DUT Type’s RF Context **IF** (default) and **RF** values. Refer to “**Frequency Range and Frequency Context**” on page 411.

Figure 23-14 DUT >Type [Downconverter], [Upconverter], and [Multi-Stage Converter] > Freq Context [IF] or [RF]–(Inactive for Type [Amplifier])

DUT – Measurement Setup – Type [Downconverter], [Upconverter], and [Multi-Stage Converter]

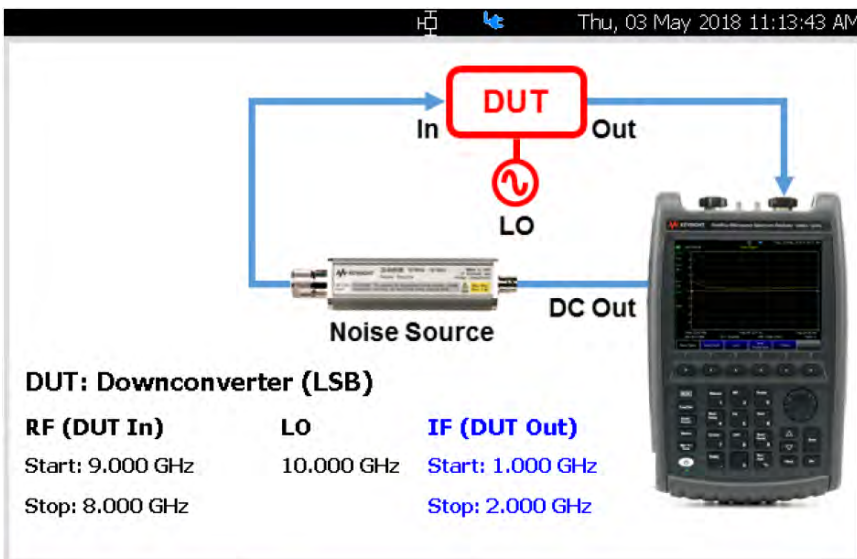

Used for setting up frequency context for a DUT

– Type [Downconverter], [Upconverter], and [Multi-Stage Converter]

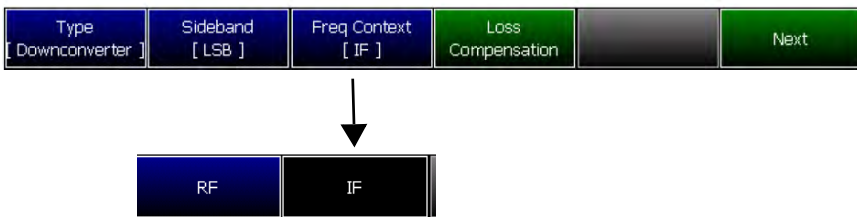

--Set the frequency context based on the DUT Type

--Enter the frequency context IF (default) or RF

Frequency Range and Frequency Context

Set the range of frequencies over which you would like to make DUT type measurements and frequency context for noise measurements.

When the frequency range is changed after a calibration is performed, the cal becomes interpolated. Learn more in [“Interpolation *” on page 138](#).

How to set Frequency Range and Frequency Context

- Press **Freq/Dist** (Measurement) or
 for Frequency Context:
 - Press **Meas Setup** > **DUT** > **RF (DUT In)** and **IF (DUT Out)**
 - Then choose from the following
 - **Start** and **Stop** frequencies - beginning and end of the sweep.
 - **Center** and **Span** frequencies - the center frequency and span of frequencies (half on either side of center).
- Follow each setting by entering a value using the numeric keypad, **▲▼** arrows, or the rotary knob.
 - After using the keypad, select a multiplier key. Learn about multiplier abbreviations in [Chapter 1, “Overview.”](#)
 - After use the **▲▼** arrows or the rotary knob, press **Enter**.

Figure 23-15

The screenshot shows a measurement setup diagram and a configuration screen. The diagram illustrates a Noise Source connected to a DUT (Downconverter) via an LO (Local Oscillator) and DC Out. The DUT has an In and an Out. The configuration screen displays the following parameters:

DUT: Downconverter (LSB)		
RF (DUT In)	LO	IF (DUT Out)
Start: 9.990 GHz	10.000 GHz	Start: 10.000 MHz
Stop: -16.500 GHz		Stop: 26.500 GHz

Below the table, a red warning message states: "Frequency out of range: RF (DUT In) RF Stop freq should be greater than IF Stop freq". The screen also shows buttons for Type [Downconverter], Sideband [LSB], Freq Context [IF], Loss Compensation, and Next. A smaller inset shows a spectral plot with a red error message: "Frequency out of range: RF (DUT In) RF Stop freq should be greater than IF Stop freq".

1. Frequency warning
 1. Tells you the setup is illogical and how to fix it
 2. Does not stop measurement
2. Frequency error
 1. Tells you that the frequency values are out of range (RF < 0 or IF < FF Minimum Start Freq or IF > FF Maximum Stop Freq)
 2. Stops measurement until you fix it
3. Frequency warnings/errors also show up on main screen

DUT Type Loss Compensation

For all of the DUT Types (Amplifier, Downconverter, Upconverter, and Multi-Stage Converter) the loss compensation, before the DUT (**BeforeDUT**) and after the DUT (**AfterDUT**) can be enabled or disabled for loss and for temperature.

Loss compensation can be used to compensate for double sidebands (DSB). Loss compensation can be used in the case of DSB measurements to compensate for the doubling of the measured noise level (i.e., 3.01 dB increase). For all sideband cases you can enable or disable **Loss** (device loss) and **Temperature** (device temperature). Refer to [Figure 23-16 on page 413](#).

This section contains the following:

- Setting **Meas Setup** > **DUT** > **Loss Compensation** > **Before DUT** and **After DUT**, see [Figure 23-16 on page 413](#).

Setting DUT Loss Compensation

Figure 23-16 DUT Loss Compensation

DUT – Measurement Setup – Type [Amplifier], [Downconverter], [Upconverter], and [Multi-Stage Converter]

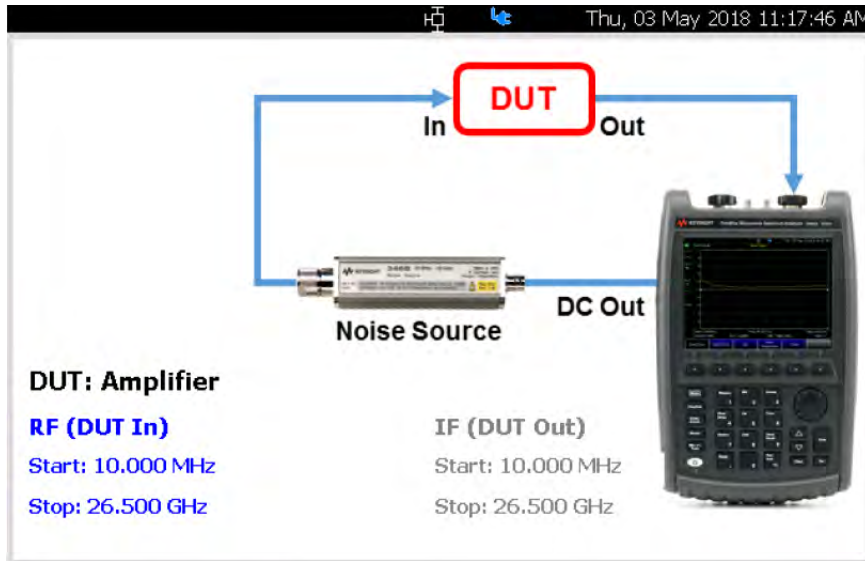

Used for setting up loss compensation for a DUT
 – Type [Amplifier], [Downconverter], [Upconverter], and [Multi-Stage Converter]



--Loss compensation can be set before and after the DUT

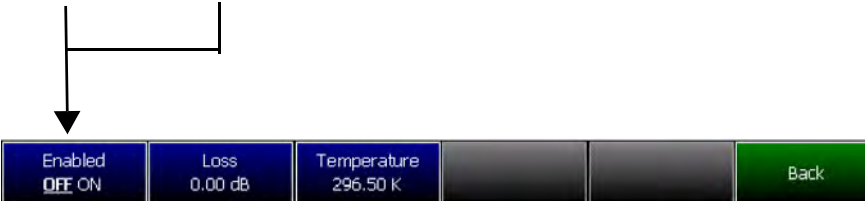

--Enable or disable the Loss (device loss) and the temperature (device temperature)

Single / Continuous / Restart

This setting determines whether the FieldFox measures continuously or only once each time the **Single** or **Run / Hold +/-** button is pressed. Use **Hold / Single** or to conserve battery power or to allow you to save or analyze a specific trace.

How to set Single or Continuous

- Press **Sweep 3**.
- Then choose one of the following:
 - **Continuous**
 - **ON** Causes noise figure (NF) to make continuous sweeps. This is the typical setting for making measurements. Each **Run / Hold +/-** press causes NF to toggle between continuous sweep and Hold.
 - **OFF** Causes NF to Hold. Each **Run / Hold +/-** or **Single** press causes NF to make ONE sweep, then Hold. The Hold annotation changes to an arrow --> while the sweep occurs.
 - **Single** Automatically sets Continuous OFF and causes NF to make ONE sweep, then Hold.
 - **Restart** Resets the sweep to the current defined start frequency point.

Points

Points is the number of measurements that are measured and displayed along the X-axis. The higher number of data points, the better the ability to resolve closely spaced signals and the slower the sweep speed.

How to set number of points

- Press **Sweep 3**
- Then **Points [current setting]**
- Then choose from: **03 | 05 | 11 | 21 | 51 | 101 | 201 | 401 | 601 | 801 | 1001**

Resolution Bandwidth (Res BW)

CAUTION

Avoid setting the resolution bandwidth (Res BW) greater than the bandwidth of the measured DUT.

In NF Mode, the Res BW settings increase the measurement speed and quality of a measured noise figure. The wider (higher) the Res BW, the faster and better the noise figure measurement. However, as the Res BW is narrowed, the sweep speed becomes slower and the measurement quality is degraded.

So: Wider Res BW = better noise measurement and faster measurement time

How to set Res BW

- Press **BW 2**.
- Then **Res BW**.
- Then choose from the following:
 - **300 KHz | 1 MHz | 3 MHz | 5 MHz** Press the desired resolution bandwidth.

The current Res BW setting is shown at the bottom of the screen.

This setting could impact the accuracy of the measurement. See Specifications in <http://literature.cdn.keysight.com/litweb/pdf/5990-9783EN.pdf>.

Alignments

The Noise Figure mode requires alignment types: amplitude. Refer to the SA chapter's "[Alignments](#)" on page 177 for information on all alignments.

Calculating Noise Figure Measurement Uncertainty

The Noise Figure mode can calculate and display the uncertainty of the noise measurement, whether it is a Noise Figure, Noise Factor, or Noise Temperature measurement.

The uncertainty calculation accounts for the following sources of uncertainty, both in the measurement and in the user calibration (Run User Cal):

- Noise power uncertainty caused by finite sample size (Jitter)
- Noise power uncertainty caused by mismatch
- ENR uncertainty of the noise standard

The following are not included because they have been determined to be insignificant:

- Linearity (i.e., due to the linear wide dynamic range receiver, the automatic gain adjustment, and the small power excursions of the hot/cold measurement)
- Residual temperature drift of the FieldFox (i.e., due to the internal reference switch)

Other possible causes of uncertainty that are not included in the uncertainty analysis are temperature drift of the following:

- DUT,
- Noise source, or
- Preamplifier

CAUTION

Generally, the drift immunity of the Y-factor noise figure measurement is quite good. Nevertheless, caution is advised when temperature changes are significant between the user calibration and measurement.

NOTE

When any one of the four uncertainty values reads all "0.00" across the band, a yellow `UNC?` annotation is displayed on the left side of the FieldFox display.

Refer to ENR [“Using ENR Tables” on page 421](#).

Reverse noise wave generation by the DUT or preamplifier

All amplifiers, including the DUT and preamplifiers used in the noise figure measurement, are active devices which may generate noise power from both their input and output ports. The Noise Figure mode uncertainty calculation does not account for uncertainties caused when the input generated noise reflects back into the amplifier and adds to the total measured noise power. These types of uncertainties are minimized by using well matched noise

sources in the measurement and in the user calibration. And, in the case of very low power output DUTs (<15 dB gain + noise figure), by using an isolator on the input of the preamplifier.

Electromagnetic interference

DUTs, preamplifiers, noise sources, and connectors may all potentially be affected by radiated signals present in the test environment. Care should be taken to establish an appropriate test environment for the noise figure measurement.

DUT oscillations, microphonic behavior, etcetera

Any instability in the DUT will cause unaccounted noise measurement uncertainties.

Entering Uncertainty Information

In addition to information gathered during the measurement, the following information must be provided by the user in order to determine the noise measurement uncertainty:

- **DUT Reflection Coefficient**

For this section, see also “[Overview of Softkey Menus](#)” on [page 395](#) ([Uncertainty](#) > [DUT](#) on [page 399](#)).

DUT Reflection Coefficients values may be imported to a DUT table from *.snp or *.csv Files, entered by editing a DUT table, recalled as a previously saved DUT table (in a *.dut file), or set as a spot value to be applied across all frequencies.

NOTE

DUT and preamplifier *.snp files may be generated in the FieldFox VNA mode, and then imported into the Noise Figure mode.

Specified Style (Spec Style): Following the GUM method for Type B evaluation of standard uncertainty described in Reference[1]¹, the uncertainty calculation takes into account not only the entered value of the reflection coefficient, but also the nature of this value. This can either be a measured value for the DUT, or some form of specified value. This is indicated by the Spec Style setting. Specified Styles may be either a percentile value, maximum, fixed, median or mean. This value indicates the nature of the entered value relative to the population of values it represents. Refer to **Table 23-1 on page 418**.

Distribution: Distribution settings refer to the population distribution of the $|\Gamma|$ values for the device. Refer to **Table 23-2 on page 418**.

Table 23-1 Specify Style – of the entered value relative to the represented population

Style	Description
Maximum	Use this if this value represents the largest possible reflection coefficient for the population of devices to which the DUT belongs. This is true for "does not exceed" specifications.
Fixed	Use this if the value is a measured value for the DUT.
Median / Mean	Use this if this value represents the median / mean reflection coefficient for the population of devices to which the DUT belongs.
95th %ile	Use this if 95% of the population has a lower reflection coefficient than the value entered. This is the case for "2 standard deviation" (2σ) type specifications.
80th %ile	Use this if 80% of the population has a lower reflection coefficient than the value entered.

Table 23-2 Distribution – of the population of the reflection coefficients

Distribution	Description
Fixed	The reflection coefficient magnitude is always at the given level. This is often the case when measured values are used.
Rayleigh	The probability density function (pdf) of the magnitude of the reflection coefficient is a Rayleigh distribution. This is normally the case for specified values when the overall mismatch is due to several interacting impedance transitions within the device.
Uniform (within a Circle)	A distribution that was historically used in the industry, before the Rayleigh research, as documented in Keysight Application Note 1449-3, but is rarely accurate. Refer to https://literature.cdn.keysight.com/litweb/pdf/5988-9215EN.pdf .

1. Reference [1]: GUM 1995 with minor corrections Evaluation of measurement data - Guide to the expression of uncertainty in measurement JCGM 100:2008 First Edition September 2008.

– **Noise Source Reflection Coefficient, ENR Uncertainties, and ENR values:**

For this section, see also [“Overview of Softkey Menus” on page 395](#) ([Noise Source](#) on [page 396](#)) and [“Using ENR Tables” on page 421](#).

Noise source reflection coefficients, ENR Uncertainties, and ENR values may be entered by Recalling a previously generated *.enr file, editing an ENR table, or set as a spot value to be applied across all frequencies. Note that any *.enr file which uses the standard *.enr file format may be recalled by the Noise Figure mode.

NOTE

Template *.enr files for several common models of noise sources may be found in the default ENR table directory of the FieldFox. In these files, the reflection coefficients have been set to the values specified for the respective model numbers, but the values for the ENR or ENR uncertainty will need to be entered at each frequency. Refer to [“ENR \(*.enr\) Files” on page 422](#).

As in the case of the DUT, in addition to entering the magnitude reflection coefficient values, the uncertainty calculation takes into account the distribution and specified style for the noise source reflection coefficient value. Additionally, the ENR table requires a value for the ENR uncertainty coverage (Uncert Coverage), which states how the entered ENR uncertainty (ENR Uncert) value is related to the population of possible ENR uncertainties. This is typically set to 2σ which means that 95% of the time, the actual ENR is within the range of ENR +/- ENR Uncertainty.

– **Preamplifier Reflection Coefficients (User Calibration Only):**

For this section, see also [“Overview of Softkey Menus” on page 395](#) ([Uncertainty](#) > [Preamp](#) on [page 401](#)).

When a user calibration is performed, the Preamplifier Reflection Coefficient values may be imported to a Preamp table from *.snp or *.csv files, entered by editing a preamplifier table (Preamp Table), recalled as a previously saved preamp table (in a *.amp file), or set as a spot value to be applied across all frequencies.

NOTE

Template preamplifier (*.amp) files for several common models of preamplifiers may be found in the default Preamp table directory of the FieldFox. In these files, the reflection coefficients have been set to the values specified for the respective model numbers.

NOTE

DUT and preamplifier *.snp files may be generated in the FieldFox VNA mode, and then imported into the Noise Figure mode.

As in the case of the DUT, In addition to entering the magnitude reflection coefficient values, the uncertainty calculation takes into account the distribution (Γ Distribution) and specified style (Spec Style) for the preamplifier reflection coefficient value.

– **User Calibration Noise Source Reflection Coefficient, ENR Uncertainties and ENR values (User Calibration Only):**

These are identical to the noise source values entered for the measurement, but are entered prior to performing the user calibration (Run User Cal).

– **Controlling the Uncertainty Calculation and Display**

For this section, see also [“Overview of Softkey Menus” on page 395](#) ([Uncertainty](#) > [Uncert Contributions](#) on [page 401](#)).

When enabled, uncertainty bars are displayed on the data trace, indicating the uncertainty range for the current Noise Figure, Noise Factor, or Noise Temperature measurement. By default, the displayed uncertainty range is the measured data +/- the default coverage factor of two times the calculated standard deviation (2σ), which is based on all included uncertainties. Optionally, the coverage factor may be changed to 1σ , 2σ or 3σ . Also, as an aid in determining the cause of measurement uncertainty, any of the individual contributors (user calibration (User Cal Uncert), mismatch uncertainty (Mismatch Uncert), ENR uncertainty (ENR Uncert), or jitter uncertainty (Jitter Uncert) may be excluded from the uncertainty analysis.

Using ENR Tables

ENR tables are used to define the noise source(s) used in DUT measurements, receiver, and user calibration(s). Additionally, ENR tables are used along with DUT tables, preamplifier tables, and information collected during the measurement to compute the measurement uncertainty. Refer to [Figure 23-17 on page 422](#).

- Both gain and noise figure measurement accuracy will be enhanced by using a noise source with as low a reflection coefficient as possible for both the noise figure measurement and the user calibration.
- It is not necessary to use the same noise source in the user calibration as will be used in the measurement. In some cases, it might be better to use a different noise source in the user calibration than will be used in the measurement. If this is done, it is important to select the ENR table for the calibration noise source prior to the calibration. And, then to select the ENR table for the measurement noise source prior to measuring the DUT.

See also, [“Calibration Wizard” on page 425](#).

How to Create an ENR Table

To create an ENR table:

This procedure assumes you have previously set your frequency, resolution bandwidth, and number of points. Refer to [“Example: Typical Noise Figure Measurement Procedure” on page 394](#).

For this procedure, refer to [Figure 23-17 on page 422](#).

1. Press **Measure** > **Noise Source** > **ENR Mode Table** (default)
2. Then **ENR Table Edit/Save/Recall**
3. Then choose:
 - Edit ENR Table** (to modify the currently loaded ENR table)
 - New ENR Table** (to create a new table)
 - Save ENR Table** (to save any changes to the currently loaded ENR table)
 - Recall ENR Table** (to recall a previously saved table)
 - Back** (to return to previous softkey menu)
4. Then edit the table as necessary for your devices and measurements by entering in Header, Auto-populate, ENR, ENR uncertainty, On $|\Gamma|$, and Off $|\Gamma|$. Refer to [Figure 23-17 on page 422](#).

Figure 23-17 Editing ENR Tables

Use knob. Press [Edit] to make changes. Press [Done] to exit. Tue, 03 Apr 2018 10:53:24 AM Page 1/1

Setting	Value			
Header				
File Type	ENR			
Version	1.0			
Serial Number	MY44420707			
Model Number	346C			
Options				
Cal Date	20170801			
Cal Due Date	20180801			
Temperature (°C)	24			
Humidity (%)	40			
ENR Uncert Cov	2 σ			
Γ Spec Style	95th %ile			
Γ Distribution	Rayleigh			
Auto Populate				
ENR	0.000 dB	Off		
ENR Uncert	0.000 dB	Off		
On Γ	0.200	On		
Off Γ	0.100	Off		
Frequency				
10.000 MHz	13.640 dB	0.000 dB	0.200	0.000

Buttons: Edit, Next Page, Previous Page, Add Row, Deletes/Clear, Done

Text on right: Uses existing ENR file format Refer to <https://literature.cdn.keysight.com/litweb/pdf/00346-90148.pdf>.
 1. Three additional header fields (used for uncertainty calculations)
 –ENR Uncert Cov
 – Γ Spec Style
 – Γ Distribution
 2. Auto Populate fields are not part of the file. These fields are only used to assist in filling the table values.
 (when a given auto-populate value is turned on, its value fills in the associated values in the table).

About ENR (*.enr), Preamplifier (*.amp), and DUT (*.dut) Files

This section contains the following:

- “ENR (*.enr) Files” on page 422
- “Preamplifier (*.amp) Files” on page 423
- “DUT (*.dut) Files” on page 423

ENR (*.enr) Files

- ENR files are saved to, and recalled from, the **NoiseFigure\ENR** folder. If the folder does not already exist on a USB or SD card, it is created automatically before storing the file.
- ENR files are stored as *.enr files. Existing ENR files that are loaded into the FieldFox can be overwritten. Your edited file will NOT be overwritten when firmware is updated.
- To **DELETE** a *.enr file, use the Manage Files feature. Learn more in “Manage Files” on page 506.

Preamplifier (*.amp) Files

- Preamplifier (*.amp) files are saved to, and recalled from, the **NoiseFigure\Preamp** folder. If the folder does not already exist on a USB or SD card, it is created automatically before storing the file.
- Preamplifier files are stored as *.amp files. Existing *.amp files that are loaded into the FieldFox can be overwritten. Your edited file will NOT be overwritten when firmware is updated.
- To **DELETE** a *.amp file, use the Manage Files feature. Learn more in **“Manage Files” on page 506**.

DUT (*.dut) Files

- DUT (*.dut) files are saved to, and recalled from, the **NoiseFigure\DUT** folder. If the folder does not already exist on a USB or SD card, it is created automatically before storing the file.
- DUT files are stored as *.dut files. Existing *.dut files that are loaded into the FieldFox can be overwritten. Your edited file will NOT be overwritten when firmware is updated.
- To **DELETE** a *.dut file, use the Manage Files feature. Learn more in **“Manage Files” on page 506**.

Using Markers (Noise Figure)

In addition to the features shown here, noise figure has many of the same marker features as other FieldFox modes. See also **“All about Markers” on page 438**.

Figure 23-18 Marker Annotation

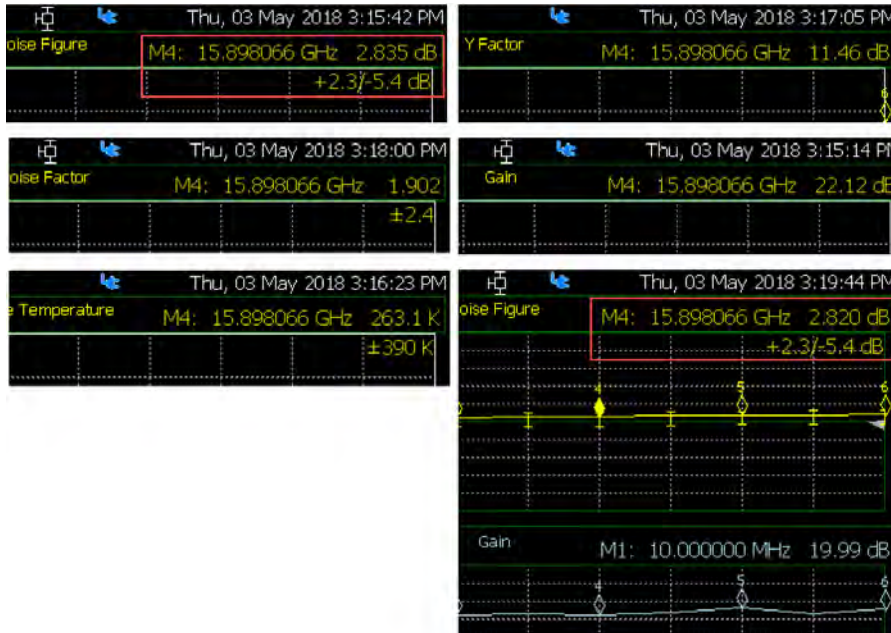

Marker annotation
 - Marker readout in top right corner of graticule.

- Displays uncertainty values for select measurements.

IMPORTANT! Noise Figure has asymmetric uncertainty (see red box in figure). Noise Factor and Noise Temperature have symmetric uncertainty.

Figure 23-19 Marker Table Annotation



Marker table annotation under the graticule.

- Marker table data under the graticule.

- Displays uncertainty values for select measurements.

IMPORTANT! Noise Figure has asymmetric uncertainty (see red box in figure). Noise Factor and Noise Temperature have symmetric uncertainty.

Calibration Wizard

The Noise Figure mode has two types of calibration wizard softkeys: Receiver Cal and User Cal.

NOTE

A receiver calibration is required for a user calibration. On the Fieldfox, after you have completed a user calibration, the User Cal (USER Cal) annotation overwrites the displayed Receiver Cal (RCVR Cal) annotation.

To access the calibration wizards:

- Press **Cal** then
 - **Run Receiver Cal** or
 - **Run User Cal** and then
 - follow the prompts

When to Calibrate

Noise Figure has two different calibrations that are important to run, depending on the type of measurement you are using:

- Receiver calibrations (required for all measurements).
- User calibrations (required, if the setup uses an external preamplifier).

Understanding Receiver and User Calibrations

This section contains the following:

- “Receiver Calibration (Receiver Cal):”
- “User Calibration (User Cal):”
- “User Calibration (User Cal):”
- “Optimizing Measurement Accuracy:”

Receiver Calibration (Receiver Cal):

NOTE

When there is no preamplifier in the measurement, only a receiver calibration is required.

The receiver calibration's purpose is to establish the true measurement bandwidth of the receiver when making noise measurements. This bandwidth information is used to calculate the gain of the DUT when there is no user calibration. But, if there is a user calibration, the gain calculation is independent of the receiver bandwidth from the receiver calibration. The

receiver calibration has virtually no influence on the noise figure measurement, either with or without a user calibration. The receiver calibration only effects the gain measurement, and only when there is no user calibration.

As already stated, the receiver calibration measures the measurement bandwidth of the receiver. In most cases, this is set primarily by the digital processing of the receiver. The receiver calibration is needed, because it is influenced by the IF analog circuitry of the FieldFox. Additionally, the bandwidth is extremely stable, and does not vary significantly with time or temperature. So, once the receiver calibration has been successfully performed there is no need to repeat the receiver calibration.

Exceptions: Re-do the receiver calibration when the FieldFox receiver hardware is changed (factory repair) or in the rare case where a filter is added to the measurement system which has a narrower bandwidth than the receiver (i.e., the external bandwidth is less than the lowest resolution bandwidth (Res BW) setting of 300 kHz).

User Calibration (User Cal):

NOTE

Performing a user calibration is recommended only when the measurement setup includes a preamplifier. The user calibration is unnecessary for accurate measurements when no preamplifier is used.

In general, a user calibration should be performed whenever a preamplifier is used in the noise figure measurement. If there is no preamplifier, the user calibration is not necessary.

Although it will be interpolated if other frequencies are used, when a user calibration is performed, it should be made at the same frequencies as the measurement. The user calibration also needs to be performed with the same resolution bandwidth as is used in the measurement. The user calibration determines the noise contribution of the preamplifier, so that it can be removed from the measurement when computing the noise figure of the DUT. Also, the user calibration establishes the power gain of the receiver–preamplifier system so that the reported gain of the DUT will be the gain between input of the DUT (where the noise source is connected during the measurement) and the calibration plane (which is the point where the noise source is connected during the user calibration). Therefore, for the best gain accuracy, the noise source used in the calibration, should be connected at the same point as the DUT will be during the measurement.

Optimizing Measurement Accuracy:

- Both gain and noise figure measurement accuracy will be enhanced by using a noise source with as low a reflection coefficient as possible for the user calibration.

Noise Figure Mode (Option 356 – CPU2 Only)
Calibration Wizard

- When the DUT output noise power is relatively low (i.e., the gain plus noise figure of the DUT is less than 15 dB), measurement accuracy may also be improved by using a low loss isolator on the preamplifier input. Due to the output reflection coefficient of the DUT, reverse noise waves from the preamplifier, when present, will contribute a different amount of noise power during the measurement of the DUT than during the user calibration. And, this change in receiver noise power can impact the measurement accuracy.
- It is not necessary to use the same noise source in the user calibration as will be used in the measurement. In some cases, it might be better to use a different noise source in the user calibration than will be used in the measurement. If this is done, it is important to set the ENR table for the calibration noise source prior to the calibration, and to set the measurement noise source prior to measuring the DUT.
- Prior to starting a user calibration, it is a good practice to connect the preamplifier and noise source that will be used during the user calibration and perform a noise figure measurement of the preamplifier itself (without a user calibration). Use the same bandwidth and frequency settings that will be used in the user calibration. A successful noise figure measurement ensures that all of the connections (bias, control, and RF) have been made properly. The user calibration can be started immediately following the successful noise figure measurement of the preamplifier, with no change to the setup.

How to use Auto-Integration

CAUTION

For optimum speed and performance measurement results, it is recommended that auto-integration is used in all noise figure measurements.

This section provides an example procedure for measuring a device using noise figures' auto integration feature. This example does not use an external preamp and was performed over a long time duration. Auto-integration is recommended to achieve greater accuracy and speed for all of your device measurements. Refer to [Figure 23-21 on page 432](#) and [Figure 23-21 on page 432](#).

For the following example, these settings were used on the FieldFox with a Keysight 346C K01 noise source that had the following characteristics:

Keysight 346C K01 characteristics at 50 GHz

ENR of 11.8 dB

Noise figure 8.7 dB

Gain 9.5 dB

Total Noise = 18.2 dB above kTB.

FieldFox N9952A noise figure (as tested): 39.3 dB

NOTE

For this example, the cold noise generation of the 346C K01 is 21.1 dB below the FieldFox's noise power (i.e., $39.3 \text{ dB} - 18.2 \text{ dB} = 21.1 \text{ dB}$).

About Auto-Integration

With auto integration, the FieldFox Noise Figure application chooses the optimum integration time for each of the noise power measurements needed (i.e., noise source on, noise source off, and receiver reference) to compute the device's noise figure with the selected amount of measurement jitter in the shortest possible time. The auto integration feature calculates the time required to satisfy the jitter goal from the relative power levels as they are measured. One significant advantage of auto integration is that it ensures that the best possible instrument speed is used in achieving the necessary jitter requirement.

If, on the other hand, it is determined that the time required to meet the jitter goal exceeds the maximum allowed time set by the user, auto integration will divide the maximum allowed time between the power measurements in order to produce the smallest possible jitter in the noise figure measurement. In

these cases, since the jitter goal has not been reached, a jitter warning marker will appear on the data trace (unless disabled by the user), indicating that the jitter goal could not be achieved within the selected time constraint.

Due to the stability of the FieldFox receiver with its internal reference switch and the design of the auto integration feature, it is possible to achieve a stable, accurate, low jitter measurement results even under challenging measurement conditions, such as when measuring low noise power output devices at high frequencies with no pre-amplifier, by setting very long maximum integration times. For example, stable measurements with 0.1 dB jitter and no discernible drift have been demonstrated measuring a low gain, low noise amplifier at 50 GHz using maximum integration times of 5000 seconds per point, in spite of ambient temperature drift of several degrees Centigrade over the course of the measurement.

While auto integration can achieve very low jitter measurements, it is a good practice to consider the contribution of the jitter uncertainty to the total measurement uncertainty when selecting a jitter goal. If the measurement uncertainty from other contributors is known to be 0.5 dB, for example, it would make little sense to set a jitter goal of 0.1 dB. Setting a jitter goal of 0.3 dB in this case would only increase the RSS uncertainty to 0.58 dB, and would potentially speed up the measurement by a factor of 9 relative to a jitter goal of 0.1 dB. Auto integration makes it possible to select the jitter level with confidence, and is therefore a valuable tool in obtaining the required level of accuracy with the fastest possible measurement time.

Auto-Integration Procedure

No user cal was performed for this measurement, because no external preamp was used.

Set the equipment up in an area where it will remain undisturbed for the determined amount of measurement time. Refer to [Figure 23-20 on page 431](#) and [Figure 23-21 on page 432](#). See also, [Figure 23-1 on page 388](#) and [Figure 23-1 on page 388](#).

1. Enter the Measurement type:

Select **Measure** > **Noise Figure** (default)

2. Enter the Noise Source ENR information into a table:

NOTE

If you have previously saved your noise source's ENR information into a table, skip this step and proceed to step 4.

Select **Measure Setup**

Then choose:

- **Noise Source** then
- **ENR Mode Table** (default)

– **ENR Table Edit/Save/Recall**

– **Edit ENR Table**

- Enter the serial number and model number of your noise source. If desired, enter other information (e.g., Options, Cal Date, etcetera).

Enter a value using the numeric keypad, the **▲▼** arrows, or the rotary knob.

- **Done** to finish table and return to previous menu.

3. Save the ENR table:

If you are not familiar with saving and recalling files, refer to **Chapter 27, “File Management.”** and then to **“Saving and Recalling Files” on page 498.**

Choose:

– **Save ENR Table**

Enter the filename of your noise source.

Enter a value using the numeric keypad, the **▲▼** arrows, or the rotary knob.

- **Done** to finish table and return to previous menu.

4. Enter the noise figure measurement’s frequency, number of points, and span settings:

– **Freq/Dist** > **Center** > 50 GHz

– **Sweep 3** > **More** > **401 points**

– **BW 2** > **Span** > 0 Hz

5. Define the noise figure’s integration settings:

Meas Setup 4 > **Integration**

Then choose

– **Mode Auto** (default)

– **Jitter Goal** > 0.10 dB

– **Max. Time/Pt** > 300s

– **Jitter Warning ON** (default)

– **Back** to return to previous menu

Press **Uncertainty** then

– **Uncert. Bars ON**

6. Leave the setup to run for desired time.

Figure 23-20 Example of Jitter Uncertainty (401 points)–with Uncertainty Bars

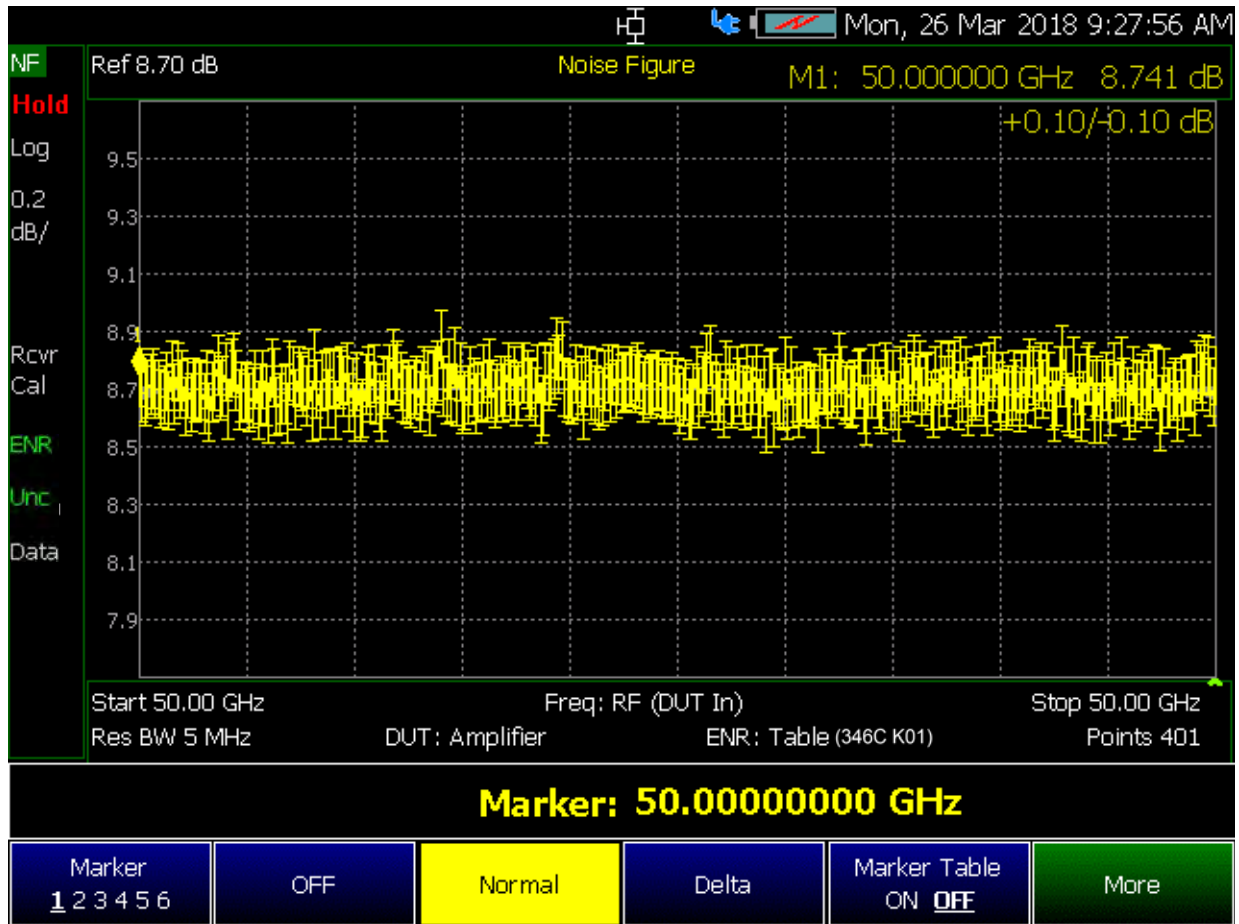

Figure 23-21 Example of Jitter Uncertainty (401 points)–without the Uncertainty Bars

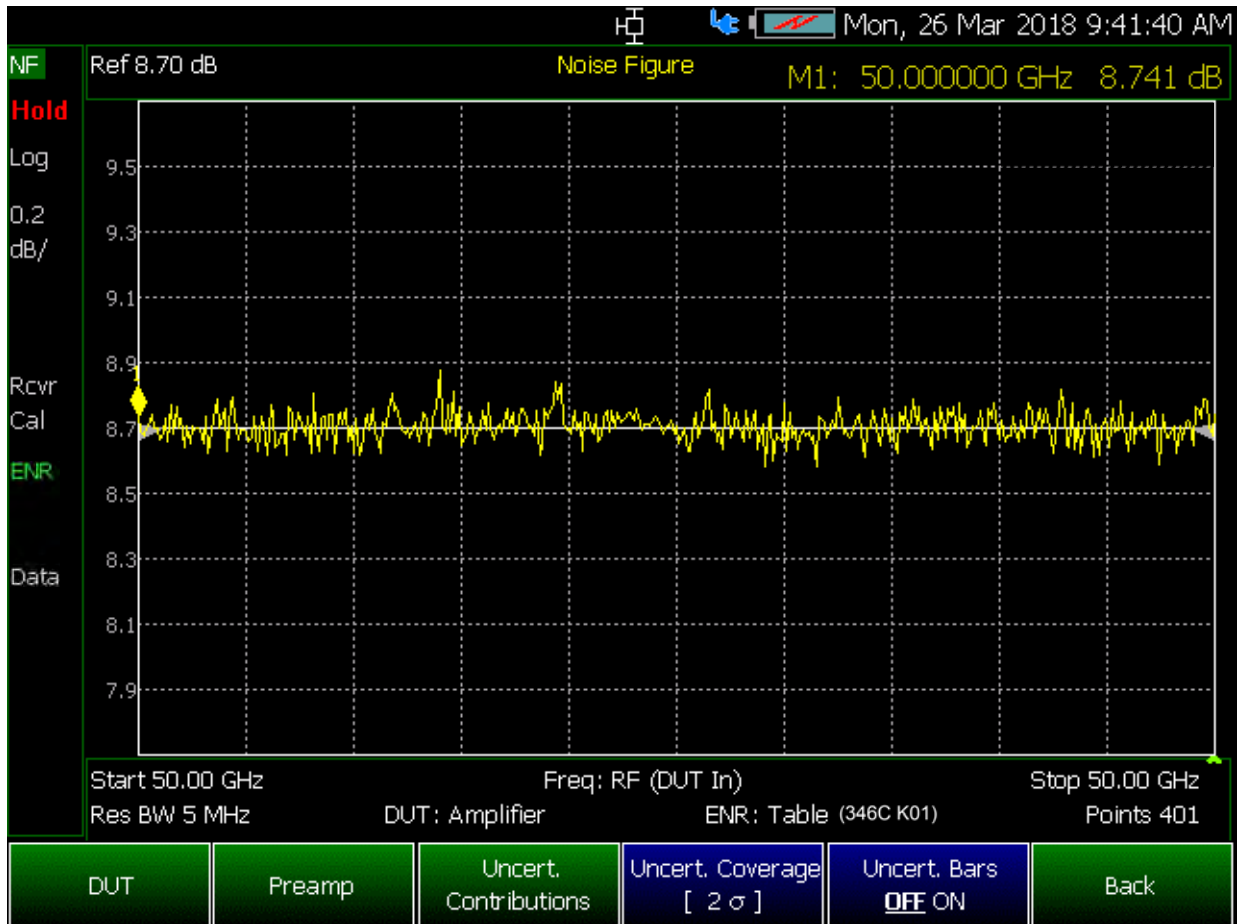
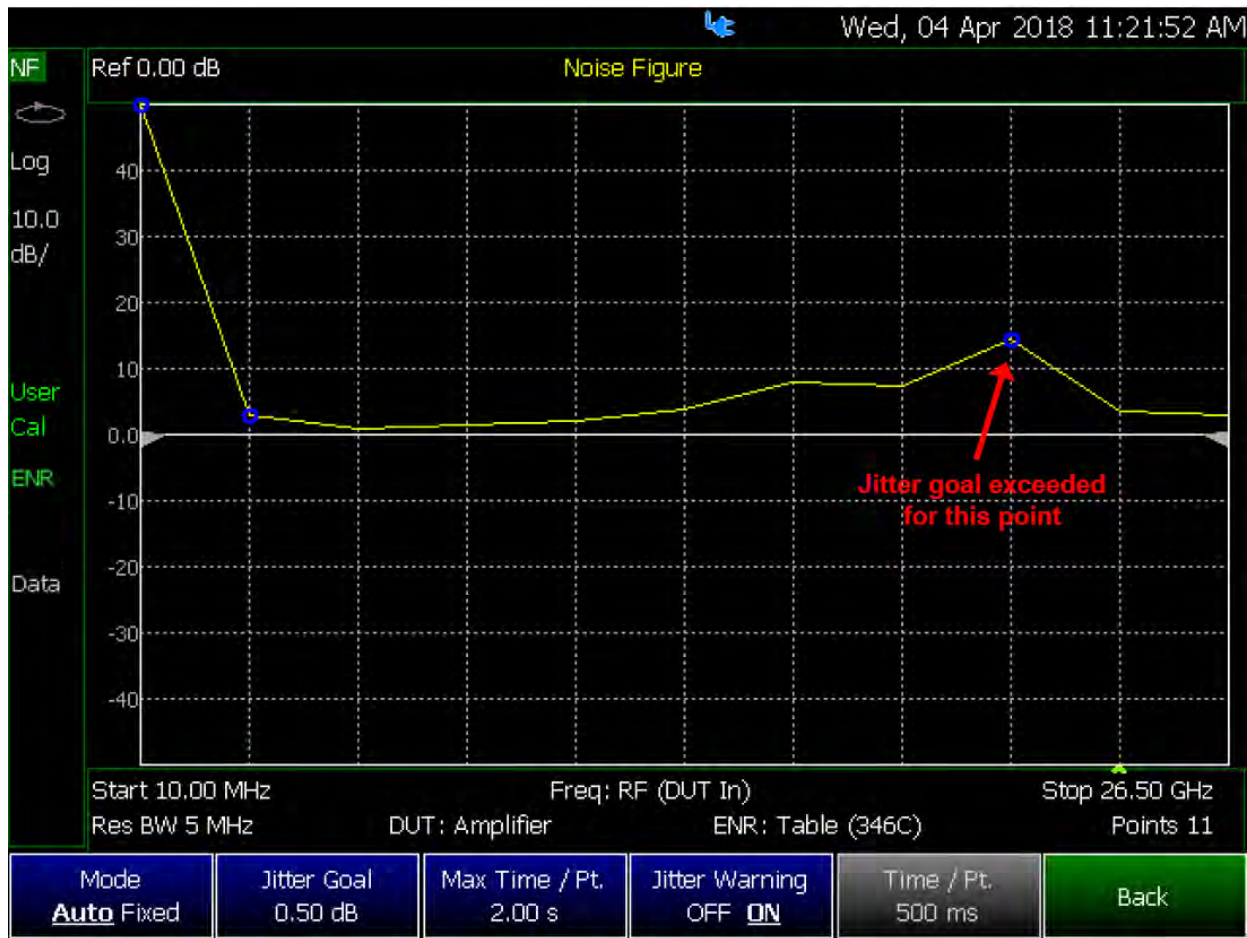

Figure 23-22 shows an example of a noise figure visual Jitter Warning elements that can be enabled/disabled (i.e, blue circles around points where the jitter goal was exceeded).

- Press to toggle **Jitter Warning OFF ON** (default = ON)

Figure 23-22 Example of Jitter Uncertainty—with Jitter Uncertainty Trace



Other Features Available

- **Limit Lines** - For information on using Limit Lines, refer to **“All about Limit Lines” on page 453**.
- **Display Lines** - For information on using Limit Lines, refer to the SA chapter’s section, **“Display Line” on page 186**.
- **Scale Settings** – For information on using Autoscale, Autoscale All, and Scale settings, **“All about Scale Settings” on page 460**.

Troubleshooting

Some measurements can result in invalid results (NaNs). In these cases the FieldFox's Noise Figure Option 356 displays the following:

- Red X on the NaN point
- Marker readout displays: "---"
- SCPI will return its NaN representation (i.e., 9.91E+37)

Figure 23-23 Example of an invalid measurement

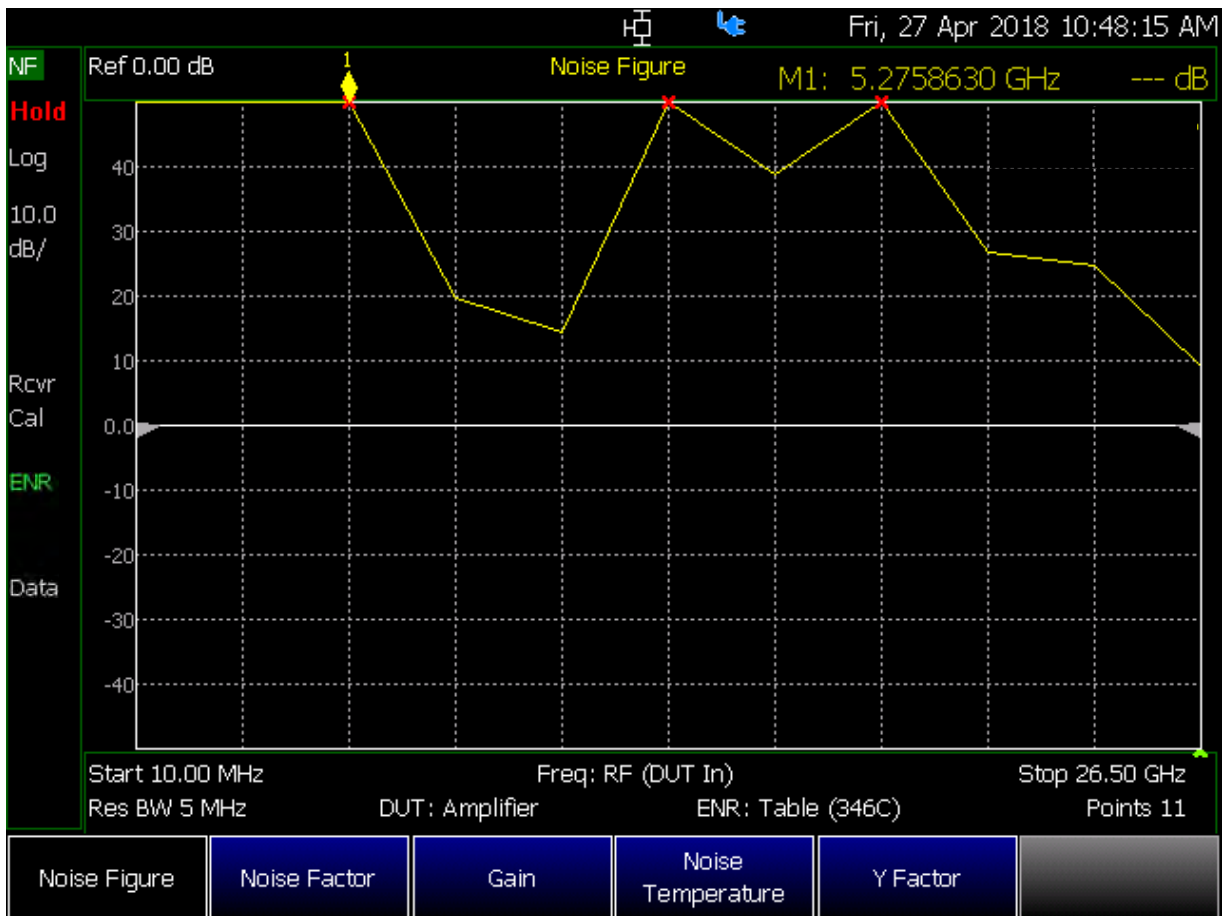

Noise Figure Mode (Option 356 – CPU2 Only)
Troubleshooting

24 Data Analysis Features

The following features can be used after a measurement to analyze the results.

In this Chapter

- “How to create Markers” on page 438
- “How to move a Marker after it is created” on page 438
- “About Delta Markers” on page 439
- “Marker Table” on page 440
- “Coupled Markers (NA Mode)” on page 441
- “Marker Trace (CAT, NA, NF Modes)” on page 442
- “Marker Trace (IQA and SA Mode)” on page 442
- “Marker Format” on page 443
- “Searching with Markers” on page 444
- “What Is a ‘Peak’” on page 449
- “Marker Functions” on page 451
- “SA Marker Functions” on page 452
- “How to Create Fixed Limit Lines” on page 453
- “Relative Limit Lines” on page 454
- “Build From Trace” on page 454
- “Limit Options” on page 455
- “How to Save and Recall Limits” on page 456
- “How to display data and memory traces” on page 458
- “How to perform Trace Math ” on page 458
- “About Math Operations” on page 459
- “How to Use Scale Settings” on page 460

All about Markers

Markers move along the X-axis range of the measurement trace to provide a numerical readout of each measured data point. Markers also allow you to search for specific Y-axis values.

A trace can contain up to six markers.

The marker readout on the FieldFox screen displays X and Y-axis information for the current active marker ONLY.

A Marker Table can be displayed that allows you to simultaneously view X and Y-axis information for all markers.

Markers can be used in **CAT**, **I/Q Analyzer**, **NA**, **NF**, **RTSA**, **SA**, and **Pulse Measurements** Modes.

How to create Markers

- Press **Marker**.
- Then **Markers 1...6** to select a marker to activate.
- Then **Normal** to activate that marker. A marker is created on the trace in the middle of the X-axis. That marker is now **active**.
- Then move the marker using the rotary knob, the **▲▼** arrows, or by entering an X-axis position with the number keys.
- Then press **Enter**.

How to move a Marker after it is created

- Press **Marker**.
- Then **Markers 1...6** repeatedly until the marker of interest is selected. The OFF, Normal, or Delta softkey is black to indicate the current setting of each marker.
- Then move the marker as when it was first created.
- Markers can also be moved using one of the marker search functions. Refer to **“Searching with Markers” on page 444**.

Figure 24-1 Marker 2 is Active, marker 1 is NOT active.

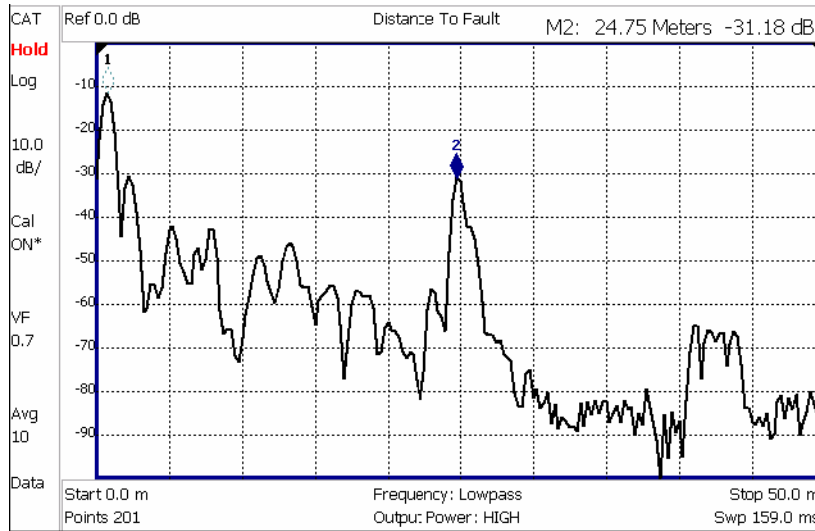

About Delta Markers

A Delta marker provides X-and Y-axis readout information that is **relative** to a 'reference' marker.

A Delta marker is created with a Δ (delta symbol) to distinguish it from the reference marker.

All six markers can be a Delta marker pair.

Peak search functions can be performed using delta markers.

Figure 24-2 A Delta marker and its associated reference marker.

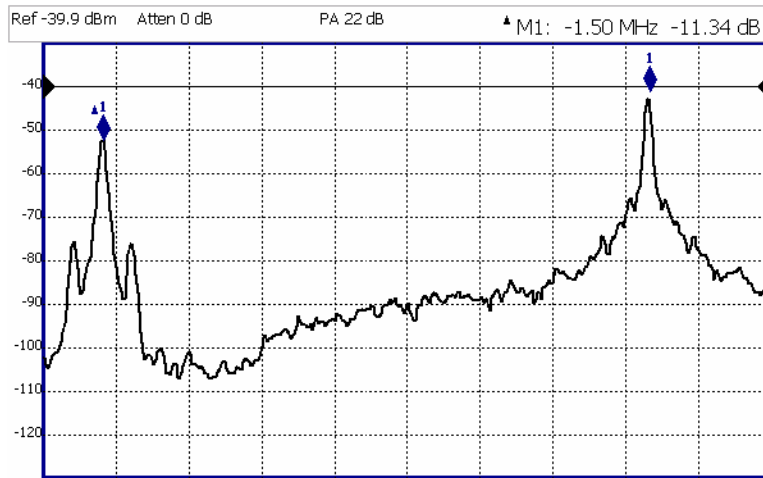

In the graphic above, the marker readout shows the difference between the two markers in frequency and amplitude.

How to Create a Delta Marker

- Create a **Normal** marker and move it to the reference position.
- Press **Delta**. The marker becomes the reference marker and fixed in its X-Axis position.
- Move the **Delta** marker using the numeric keypad, the **▲▼** arrows, or the rotary knob.
- Press **Enter** when finished.

How to move the Reference marker

- Press **Normal** to turn the Delta marker OFF.
- Move the marker to the new position.
- Then press **Delta** again, to turn the Delta marker back ON.

Fix the position of the Reference marker (I/Q Analyzer, RTSA, and SA Modes ONLY)

In SA mode, the reference marker can be fixed at the Y-axis position of the data trace when the marker was created, or it can ‘float’ with each sweep at the Y-axis position of the data trace. In CAT and NA mode, the reference marker always floats with the data trace.

- Create a Delta marker.
- From the **Mkr ->/Tools** menu, press **More** (SA mode only), then **Marker Properties**, then **Delta Ref Fixed**
 - **OFF** – The reference marker floats at the data trace Y-axis position.
 - **ON** – The reference marker is fixed at the Y-axis position of the data trace when the marker was created (default IQA and SA modes).

Signal Track Marker (NF and SA Mode ONLY)

In NF and SA mode, the marker can be peaked at the Y-axis position of the data trace and the marker is centered on the screen. This setting applies to all NF and SA markers.

- Create a Signal Track marker (peak).
- From the **Mkr ->/Tools** menu, press **More**, then **Marker Search**
 - **OFF** – The reference marker floats at the data trace Y-axis position.
 - **ON** – The reference marker is peaked at the Y-axis position of the data trace and the marker is centered on the screen.

Marker Table

The Marker Table can be displayed at the bottom of the FieldFox screen. It can display information for up to 6 markers in a full-width window, and up to 3 markers for a half-width window (NA mode). The marker table “squeezes” the graticule area when activated.

How to display the Marker table

- Press **Marker**.
- Then **More**
- Then **Marker Table On Off**.

Coupled Markers (NA Mode)

NOTE

I/Q Analyzer (IQA) mode has coupled markers. but the behavior is different than the NA mode Coupled Markers behavior. Refer to **“Coupled Markers (Waveform Only)”** on page 256.

Coupled Markers, available in NA mode only¹ and allows you to simultaneously create and move markers that have the same number for all traces. For example, when marker 2 is created on a trace, a marker 2 is created for ALL traces. When any marker 2 is moved, they all move together to the same X-axis position.

- Coupled markers are allowed only in NA mode and are relevant only in multi-trace configurations.
- You can have markers that are coupled and others that are uncoupled.
- Peak functions move the marker to the peak on the active trace, while all other markers move to the same X-axis position.

Figure 24-3 Coupled Markers move on ALL traces at the same time (NA shown).



1. IQA mode has coupled markers, but the behavior is different than NA mode's coupled markers. Refer to **“Coupled Markers (Waveform Only)”** on page 256.

How to create Uncoupled Markers

NOTE

Markers are coupled by default.

To create markers that are NOT coupled (move independently on each trace):

- Press **Marker**
- Then **More**
- Then **Coupled Markers OFF**

Marker Colors

As shown in the above image, in NA and CAT Modes, markers are the same color as the trace to which they are assigned. In SA Mode, the marker color is NOT the same as the trace.

Marker colors can NOT be changed.

Marker Trace (CAT, NA, NF Modes)

The Marker Trace setting is used to move markers between the data trace and memory trace.

When Coupled Markers is ON, this setting applies to the active marker for ALL traces that are coupled. Otherwise, this setting applies to the active marker on only the active trace.

How to move a marker between traces

- With at least one marker present, press **Marker** then **More**.
- Then select the marker to move using **Marker 1,2,3,4,5,6**.
- Then toggle **Marker Trace Auto Data Mem**.
 - **Auto** - Marker resides on data trace when it is visible. Marker resides on memory trace when only IT is visible (Default setting).
 - **Data** - Marker resides on data trace, even when not visible.
 - **Mem** - Marker resides on memory trace, even when not visible.

Marker Trace (IQA and SA Mode)

Marker Trace determines the trace number on which a marker resides. A marker is created on, or can later be changed to, the trace number specified by the Marker Trace selection. When changed, a marker moves to the same X-axis location on the specified trace.

Learn more about IQA Traces in [“Trace Display States \(IQA Mode\)” on page 259](#).

Learn more about SA Traces in [“Trace Display States \(SA Mode\)” on page 175](#).

How to move a marker between traces

- With two or more traces present, press **Marker** and **Enter** to create a marker. The marker is created on the current Marker Trace selection (default setting is 1).
- Then **More**
- Then select the marker to move using **Marker 1,2,3,4,5,6**.
- Then toggle **Marker Trace 1,2,3,4**
 - The selected marker is moved to the specified trace.
 - When a marker is moved to a 'blank' trace (not visible) the marker moves to the same X-axis position at either the Y-axis position of the last data, or to the ZERO position.

Marker Format

The Marker Format setting allows you to choose the format of the marker readout that appears in the upper-right corner of the screen and in the marker table. The marker format can be independent of the trace format, and can be set independently for each trace. All markers on a trace have the same marker format.

How to choose marker format

- Press **Marker**
- Then **More**
- Then **Marker Format**
- For **NA Mode** measurements, choose from the following:

Selection	Example Y-axis value
Default Same as displayed format	
R + jX Complex impedance format (3rd number is distance for Time Domain)	22.8Ω -j61.4Ω 287.9fF
Z Magnitude Impedance Mag.	66.08Ω
Phase	73.8°
Real	0.2003
More	
Imaginary	-0.6727
Mag & Phase	0.705, -73.7°
dB Angle	-2.1 dB, -138.2°

There are more trace formats available than marker formats. To display marker readouts in more formats than are shown here, change the trace format, then select **Default**. Learn how to change format in **“Format” on page 92**.

- For **TDR (CAT) Mode**, choose from **Default** and **Z Mag**.

Searching with Markers

Marker Searches are used to move markers to locations on the trace which exhibits the characteristics of the search criteria. Learn ‘What is a Peak’ in **“What Is a ‘Peak’” on page 449**.

How to Search with Markers

The following menu structure applies to NA Mode. Keystrokes will be slightly different for CAT, Pulse Measurements, and SA Modes.

- Activate the marker to be used for the search (NOT necessary with Bandwidth search.)
- Then press **Mkr ->/Tools**.
- Then choose one of the following:
 - **Tracking ON OFF** (NA Mode ONLY)
 - **ON** causes the active marker to search for the specified criteria with each new sweep. Search criteria can include: Target, Bandwidth, Peak, Min. The searches begin with the first sweep after Tracking is turned ON, based on the current search type. **Trk** appears next to the marker number.
 - **OFF** causes a new marker search only when the search feature is re-executed.
 - **Peak** Moves the active marker to the HIGHEST amplitude data point of the trace. Peak Excursion and Peak Threshold value is ignored. In SA Mode, the LO feed-through signal (0 Hz) is also ignored.
 - **Next Peak** Moves the active marker to the next highest amplitude data point of the trace. Peak Excursion value is ignored.
 - **Mkr -> Center** Moves the current active selected marker to the center frequency for the current frequency range displayed.
 - **Mkr -> RefLev** Moves the current active marker to the acquisition.
 - **Minimum** (Not available in DTF, RTSA, SA, or I/Q Analyzer) Moves the active marker to the LOWEST amplitude data point of the trace.
 - **Min Search** (I/Q Analyzer, RTSA, and SA modes Only) Moves the active marker to the LOWEST amplitude data point of the trace. If a marker is turned off, it is turned on before the minimum search is performed.
 - **Target** (NA Mode and Pulse Measurements ONLY) Enter the Target value. The marker moves to the first occurrence of the Target value to the right of its current position. The FieldFox interpolates between measured data points to find the exact Target value to two decimal points. The interpolated X-axis value is displayed in the marker readout or marker table. Subsequent presses of the Target softkey cause the marker to move to the right to

find the next occurrence of the Target value. When the marker reaches the end of the stimulus range, it “wraps around” and continues the search from the beginning of the stimulus range.

- **Bandwidth ON OFF** (NA Mode ONLY) Use to quickly toggle BW Markers ON and OFF. When OFF, the marker table appears showing the X and Y-axis positions of all enabled markers.
- **Bandwidth** (NA Mode ONLY) Specify the level in dB from the peak or valley where bandwidth is measured.
 - **Negative** numbers search for a **Peak** bandpass, such as a filter S21 response.
 - Either of the following TWO methods can be used to search for a **Valley** or Notch filter, such as the S11 response of a bandpass filter.
 - **Negative** values search down from the TOP (MAX) of the response.
 - **Positive** values search up from the BOTTOM (MIN) of the notch.
 - If you first enter Negative, then Positive values, it may be necessary to press **Marker**, then **More**, then **Markers All Off**.

Figure 24-4 S21 of a filter with BW Markers and associated readout values. The search criteria is -3 dB.

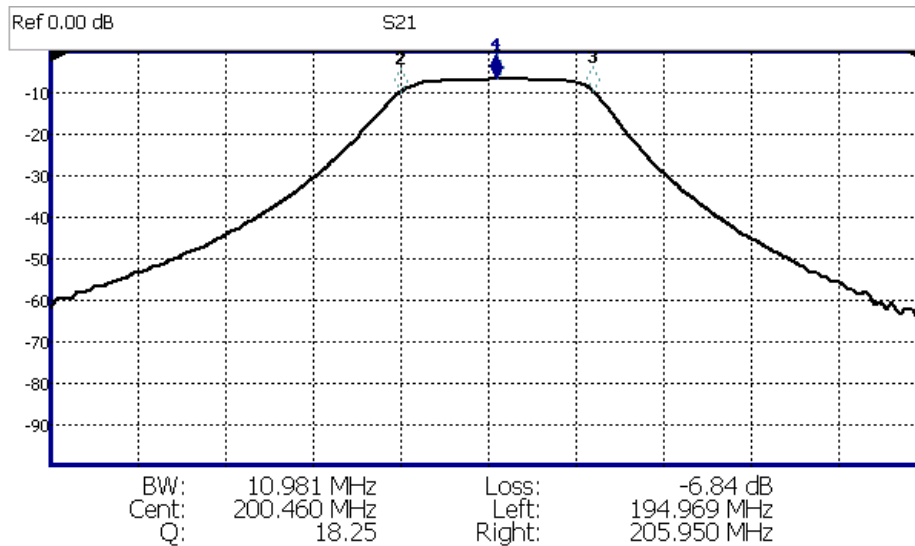
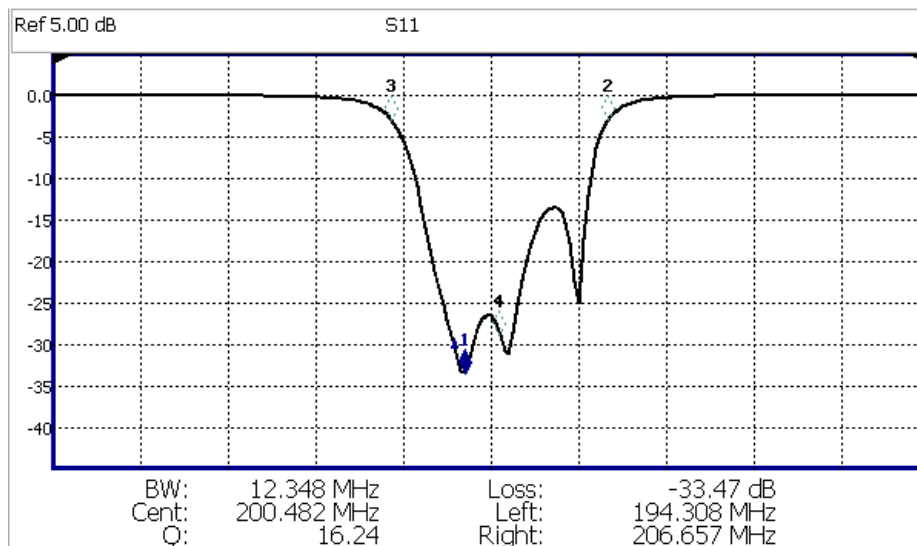

Figure 24-5

S11 of the same filter with same search criteria: -3 dB.
The same values would result from a search criteria of approximately +30.4 dB.



After pressing **Bandwidth**, four markers are automatically created to find the first negative or positive bandpass over the displayed frequency range.

Bandwidth Search can be used ONLY with Log Mag display format.

- The following six values are displayed for Bandwidth Search:
 - **BW**: Width of the filter. (marker 2 freq) **minus** (marker 3 freq).
 - **Center**: Marker 4 frequency. Mathematical midpoint between marker 2 and marker 3.
 - **Q**: Center Frequency / Bandwidth.
 - **Loss**: Marker 1 amplitude.
 - **Left**: Frequency of marker 2 or 3 (to left of marker 1).
 - **Right**: Frequency of marker 2 or 3 (to right of marker 1).
 - Press **Back** to return to the previous menu.

Press **Peak Search** then choose from the following:

- **Peak** Moves the active marker to the HIGHEST amplitude data point of the trace. Peak Excursion value is ignored. In SA Mode, the LO feed-through signal (0 Hz) is also ignored.
- **Next Peak** Moves the active marker to the next highest amplitude peak from where it currently resides.
- **Peak Left** (Not IQA) Moves the active marker to the next data point to the left that meets the 'Peak' criteria. When no data points to the left meet the 'Peak' criteria, the marker does not move.

- **Peak Right** (Not IQA) Moves the active marker to the next data point to the right that meets the 'Peak' criteria. When no data points to the right meet the 'Peak' criteria, the marker does not move.

The following applies to DTF Measurements ONLY:

- **More** then:
 - **Track Peaks ON OFF** When Track Peaks is ON, markers will find the new peak with every sweep. While in this Mode, the markers can NOT be turned OFF or moved.
 - **Find 3 Peaks** Three markers are created and find the highest peaks (faults) on the trace.

The following applies to IQA Measurements ONLY:

- **More** then:
 - **Min Search** Moves the active marker to the minimum frequency (IQA displays time) currently displayed on the screen.
 - **Mkr Properties** then:
 - **Peak Criteria** then refer to **“How to set Peak Criteria” on page 449:**
 - **Delta Ref Fixed** Enables or disables the delta reference fixed marker.
 - **Peak Left** (IQA Spectrum Only) Moves the active marker to the next data point to the left that meets the 'Peak' criteria. When no data points to the left meet the 'Peak' criteria, the marker does not move.
 - **Peak Right** (IQA Spectrum Only) Moves the active marker to the next data point to the right that meets the 'Peak' criteria. When no data points to the right meet the 'Peak' criteria, the marker does not move.

Using Mkr5/Mkr6 to find mins/maxs between Mkr1 and Mkr2 / Mkr3 and Mkr4 (CAT and NA Mode)

Use this feature to search minimum and maximum values within sub-spans defined by Mkr1 and Mkr2, and Mkr3 and Mkr4. This facilitates measuring minimum and maximum values on your uplink and downlink channels, or only in the passband of a DUT. Use in conjunction with marker table and limit lines to verify your DUT's signals and to adjust or tune as needed. See also, **“All about Limit Lines” on page 453.**

When markers are set to Normal, Mkr5 and Mkr6 can be used to find the minimum and or maximum values between Mkr1 and Mkr2 (using Mkr5) and Mkr3 and Mkr4 (using Mkr6). Refer to [Figure 24-6 on page 449](#).

NOTE

If your Markers are positioned and in Normal marker mode, no changes are made to the Mkr1 through Mkr4 settings.

If your Markers are not previously positioned and in Normal marker mode, when you select the Mkr5 and Mkr6 maximum and minimum setting, your markers are set as follows:

- Markers are all set to **Normal**
- Mkr1 and Mkr3 are set to 1/4 full span
- Mkr2 and Mkr4 are set to 3/4 full span

How to use the Mkr5 and Mkr6 markers to find maximums and minimums between your Normal markers (CAT and NA Mode):

This section assumes you understand the previous marker features. And, that you have previously positioned your markers (Mkr1 and Mkr2 or and Mkr3 and Mkr4) and set the markers up as **Normal** markers using [“How to create Markers” on page 438](#) and other previous marker sections. For example, if your markers are set to **Delta**, change to **Normal**, and verify the marker positions are correct. Refer to [Figure 24-6 on page 449](#).

- Then press **Mkr ->/Tools**.
- Then **More** (For DTF, TDR measurements, and NA Mode, skip this step and proceed to the next step.)
- Then **Mkr5 & Mkr6 Search**
- For Mkr1 & Mkr2 maximum or minimum value search:
 - Then **Mkr5 Peak** or
 - **Mkr5 Min**
- Or for Mkr3 & Mkr4 maximum or minimum value search:
 - Then **Mkr6 Peak** or
 - **Mkr6 Min**

Figure 24-6 CAT Mode Mkr5 and Mkr6 Search Example

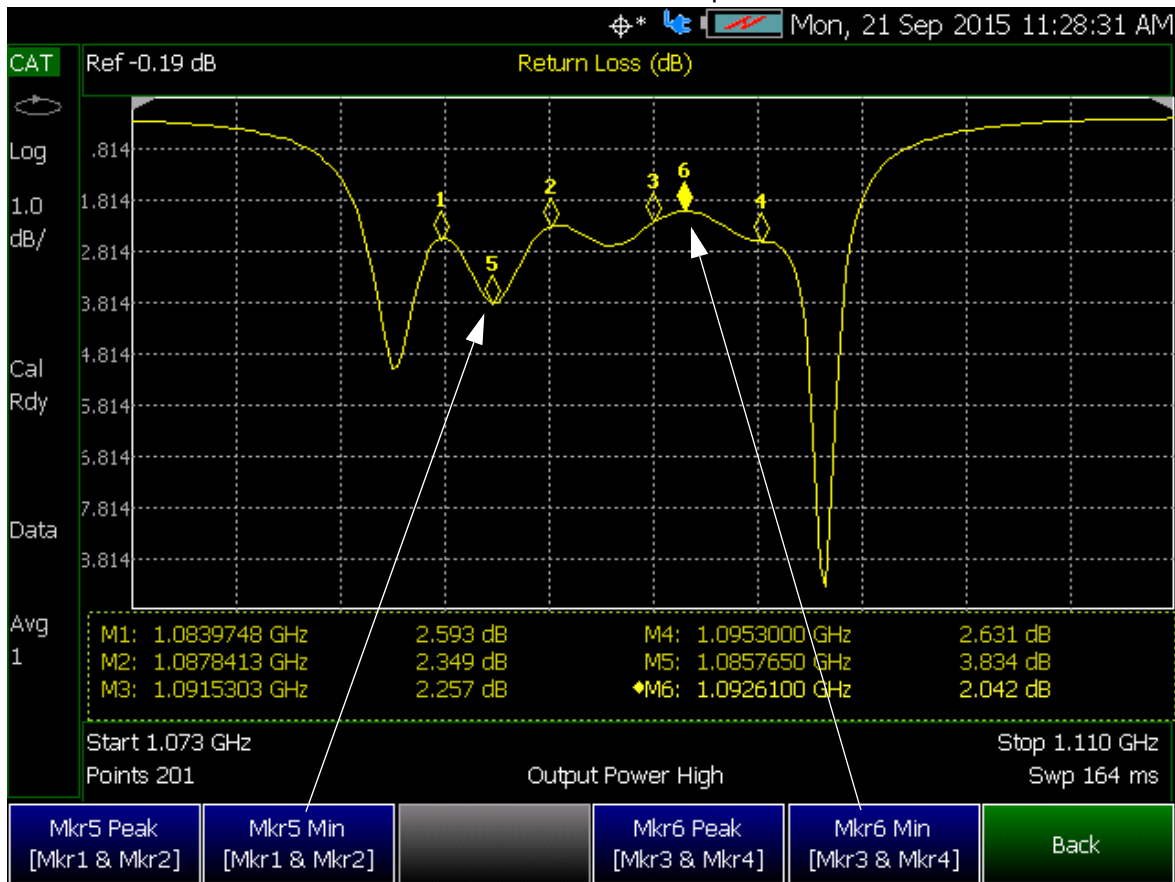

What Is a 'Peak'

You define what the FieldFox considers a “peak” by setting the Peak **Threshold** and Peak **Excursion** and for I/Q Analyzer Only **Cont Peak Search**.

These two peak criteria settings are set individually for each trace and for each mode (CAT, SA, or NA).

These settings do NOT survive a FieldFox or Mode Preset.

NOTE

The Peak Threshold and Excursion settings are NOT available in DTF measurements. To make these settings, create a non-DTF CAT mode measurement, then change the measurement back to DTF.

How to set Peak Criteria

- Press **Mkr ->/Tools**.
- In **CAT** and **NA** modes:
 - Then **Peak Search**.
 - Then **Peak Criteria**

- In **IQA** (Spectrum) and **SA** mode:
 - Then **More**
 - Then **Mkr Properties**
 - Then **Peak Criteria**
- In **IQA** (Waveform) mode:
 - Then **Mkr Properties**
 - Then **Peak Criteria**

After selecting Peak Criteria for CAT, IQA, NA, or SA mode:

- Then select the following:
 - Peak Threshold** Minimum amplitude (dB). To be considered valid, the peak must be above the threshold level. The valley on either side can be below the threshold level.
Default = -190 for CAT and NA Modes; -90 for SA Mode.

NOTE

CAT mode Loss measurements are displayed in positive values. In these cases, the Peak Threshold setting is inverted. For example, Peak Threshold = -20 will consider any peak that has less Loss than 20 dB to be valid.

- Peak Excursion** The vertical distance (dB) between the peak and the valleys on both sides. To be considered a peak, data values must “fall off” from the peak on both sides by the excursion value. Default = 0.5 dB for CAT and NA Modes; 6 dB for SA Mode.
- Cont Peak Search** (I/Q Analyzer Only) Enables or disables the Continuous Peak Search marker. When Continuous Peak Search is on, a peak search is automatically performed for the selected marker after each sweep. The rules for finding the peak are exactly the same as for Peak Search, including the use of peak criteria rules. See also, **“Using Markers (IQA)” on page 254.**
- Delta Ref Fixed** Enables or disables the delta reference fixed marker.

Peak Excursion and Peak Threshold example—the settings for the trace in the following image are:

- Threshold: -10 dB
- Excursion: 1 dB
- Scale = 1 dB / Division.

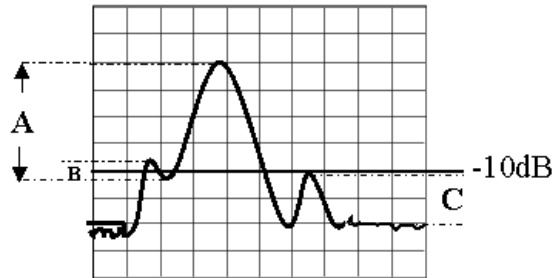

Peak A = **Valid Peak** (Above Threshold and Excursion Settings)

Peak B = Invalid Peak (Below 1 dB Excursion Setting)

Peak C = Invalid Peak (Below -10 dB Threshold Setting)

Marker Functions

Marker functions are used to change FieldFox frequency or distance settings to those of the active marker.

How to use Marker Functions

- Activate the marker to move.
- Then press **Mkr ->/Tools**
- Then **Mkr ->** (this step not required for I/Q Analyzer mode)

Then choose one of the following:

- **Mkr -> Center** (**Not** available in DTF, I/Q Analyzer (waveform), or SA mode with zero span) The center frequency of the measurement becomes the value of the active marker. The frequency span is adjusted accordingly.
- **Mkr -> Delay** (NA mode ONLY.) The group delay value of the active marker becomes the electrical delay setting of the trace. Learn how to set group delay format in **“Calibration Settings” on page 91**e. Learn more about electrical delay in **“Electrical Delay” on page 95**.
- **Mkr-> RefLev** (IQ Analyzer (NOT waveform) and SA mode ONLY) The acquisition becomes the magnitude of the active marker.
- **Mkr-> TuneFreq** (SA mode with Tune & Listen ONLY) The Tune & Listen Frequency becomes the frequency of the active marker.

The following applies to DTF Measurements ONLY:

- **More** then:
- **Mkr->Start Distance** The Start Distance of the measurement becomes the value of the active marker. Markers that would no longer appear on the screen are moved to the new Start Distance.
- **Mkr->Stop Distance** The Stop Distance of the measurement becomes the value of the active marker. Markers that would no longer appear on the screen are moved to the new Stop Distance.

I/Q Analyzer (IQA) Marker Functions

The following Marker Functions are available in I/Q Analyzer Mode ONLY (exceptions are noted):

- Noise Marker (Available in SA mode)
- Band/Interval Power Marker (Available in SA mode)
- Coupled Markers
- Band Span
- Interval Band Span
- Continuous Peak Search

Learn more about Noise and Band/Interval Power marker functions starting in the IQA chapter here: **“Noise Marker” on page 254.**

SA Marker Functions

The following Marker Functions are available in SA Mode ONLY (exceptions are noted):

- Noise Marker (Available in I/Q Analyzer mode)
- Band/Interval Power Marker (Available in I/Q Analyzer mode)
- Frequency Counter at Marker
- Audio Beep with Marker
- Time Zero Fixed Marker

Learn more about these marker functions starting in the SA chapter here: **“Noise Marker” on page 187.**

All about Limit Lines

Limit lines are visual representations, drawn on the FieldFox screen, of the specified limits for a measurement. With this capability, you can easily compare measured data versus specifications. Optionally, you can enable an audible beep and display **Pass or Fail** information for each measurement.

NOTE

IMPORTANT! For CAT and NA modes, limit lines do not apply where $F1 = F2$.

- You can have up to as many limit line segments as there are data points for each measurement trace allowing you to test all aspects of your measurements.
- Limit lines are available in CAT Mode, NA Mode, NF Mode, and SA Mode. Power Meter Mode uses different limit settings. Learn more in [“Limits” on page 306](#).
- Limit lines and limit testing are NOT allowed in NA Mode with **Smith Chart** or **Polar** display formats.
- A simple Display Line is also available in I/Q Analyzer, NF, and SA Modes ONLY. Learn more in [“Display Line \(I/Q, NF, and SA Modes Only\)” on page 457](#).
- Limit lines can be saved and recalled with an *.sta file. Learn more in [“How to Save and Recall Limits” on page 456](#). They can also be saved and recalled independently from the Limit softkeys. Learn more in [“How to Save and Recall Limits” on page 456](#).

How to Create Fixed Limit Lines

There are two ways to build a Fixed limit line:

1. **Build (limits) From a Trace.** Learn how in [“Build From Trace” on page 454](#).
2. **Enter X/Y data points into the on-screen editor.** The limit line is formed as the FieldFox ‘connects the dots’ on the screen. To create frequency gaps that are NOT tested, use separate limit lines. The X-axis values for two lines can overlap.
 - Press **Limit 8**.
 - Then **Edit Limits**. A limit line table appears.
 - Use the Up / Down arrows and rotary knob to navigate the cursor to the following editable cells.
 - **Description** – Press **Edit**, then enter a description for the limit line using the FieldFox labeler. Learn how in [“How to use the FieldFox labeler ” on page 500](#).
 - **Fixed/Relative** – Press **Edit** to toggle between the following:
 - **Fixed** – the limit line does not move. The X/Y coordinates are absolute locations on the screen.
 - **Relative** – the limit line moves relative to the center frequency and acquisition.
Note: It is easiest to first create Fixed Limits, then change this setting to Relative. Learn more [“Relative Limit Lines” on page 454](#).
 - **Upper/Lower** – Press **Edit** to toggle between the following:

- **Upper** - FAILS any measured data point **ABOVE** the line.
- **Lower** - FAILS any measured data point **BELOW** the line.
- **Off/On** – Press **Edit** to toggle between the following:
 - **On** - Limit line is drawn on the screen and PASS/FAIL testing occurs.
 - **Off** - Limit line is NOT drawn on the screen and testing does NOT occur.
- **Frequency** – Enter a numeric X-axis value of the data point.
- **Amplitude** – Enter a numeric Y-axis value of the data point.
- Press **Add** then choose from the following:
 - **Add Point** – Adds a blank X/Y data point below the cursor.
 - **Add Limit** – Adds a default limit line below the current limit.
- Press **Clear** then choose from the following:
 - **Clear Point** – Removes the X/Y data point on which the cursor resides.
 - **Clear Limit** – Removes the limit Line on which the cursor resides.
 - **Clear All** – Removes ALL limit lines.
- Press **<Back** to return to the Limit menu.

Relative Limit Lines

Relative limit lines are X/Y coordinates that are referenced to the center frequency (X-axis) and acquisition (Y-axis).

Use relative limits to test devices or signals that are identical except for the center frequency or amplitude. With relative limit lines in place, you change the center frequency of the measurement and the limits look as though they are in the same location.

The same is true for acquisition. When you expect to measure a different power level, instead of changing the Y-axis value of all of the fixed limits, simply change to relative limits. The limits will then remain a constant Y-axis distance from the acquisition.

Each limit line can be changed at any time from Fixed to Relative, and Relative to Fixed.

How to Create a Relative Limit Line

The easiest way to create a Relative limit line is to create a Fixed Limit at a specific center frequency and acquisition. Learn how **“Relative Limit Lines” on page 454**. Then change the limit line to Relative. The X/Y data points will be re-calculated relative to the center frequency and acquisition.

Build From Trace

A limit line can be built from an existing trace. One X/Y point is made from each measured data point. Then, using an offset value, you can shift the limit line UP for upper limits or DOWN for lower limits.

Once limit lines have been built from the trace, changes that you make to the trace, such as frequency range, do NOT change the limits. However, the limit line properties can be edited just like standard limit lines.

Figure 24-7 A lower limit line (red) built from the trace (yellow) shifted down 5 dB.

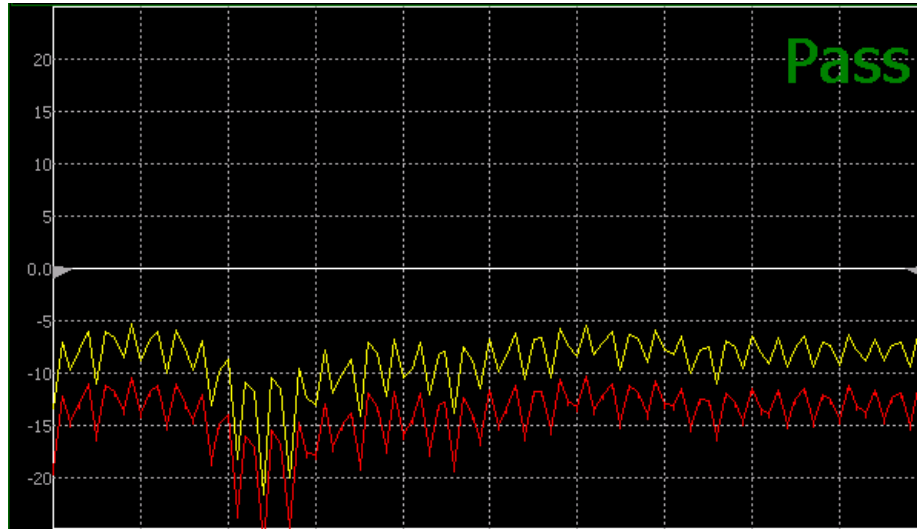

How to Build Limit Lines from a Trace

NOTE

Build from Trace is NOT allowed for traces with more than 1001 data points.

- Select the trace from which limits will be built.
- Press **Limit 8**.
- Then **Edit**.
- Then **Build From Trace**. A limit line table appears.
- Use the **▲▼** arrows to select ON.
- Use **Offset** to shift the limit line UP or DOWN. Learn how below.

Limit Options

How to set Limit Options

- Press **Exit** if the limit table is visible.
- Then **Options**.
- Then choose from the following:
 - **Beep**

- **On Pass** Audible beep sounds when a sweep passes.
- **On Fail** Audible beep sounds when a sweep fails.
- **Off** No audible beep sounds.
- **Warning On Off** Shows Pass or **Fail** indication on the display with each sweep. Data points that fail are highlighted.
- **Limit Type** Then Fixed or Relative.
- **Offset** Shifts the limit line up or down. Enter an offset value using the rotary knob, the **▲▼** arrows, or by entering a value with the number keys.
 - Enter a **positive** offset to shift the limit line UP, usually used with UPPER limits.
 - Enter a **negative** offset to shift the limit line DOWN, usually used with LOWER limits.
- **Margin** Shifts the limit line up or down like an offset, but only virtually. The limit line does NOT appear to move. Enter a Margin value using the rotary knob, the **▲▼** arrows, or by entering a value with the number keys.
 - Enter a **positive** margin to virtually shift the limit line UP.
 - Enter a **negative** margin to virtually shift the limit line DOWN.

How to Save and Recall Limits

- Press **Save/Recall** then **Device** to set the Device (Internal, SD card, or USB flash drive) to be used for the Save or Recall. Learn more in **“Set File Type and Select Device” on page 503**.
- Then press **Limit**.
- Then choose from the following:
 - **Save Limits** After limit lines have been defined, this saves the line definition to a file on the specified device.
 - **Recall Limits** Recalls a limit Line definition from the specified device.

Display Line (I/Q, NF, and SA Modes Only)

A display line is a simple, horizontal line that can be placed at any amplitude level on the SA screen or set to any level in IQA. Use a display line as mental guide for visual feedback. A display line is similar to a Limit Line, except that no PASS/FAIL testing occurs. A display line is easier to create than a Limit Line. Learn more in [“All about Limit Lines” on page 453](#).

Figure 24-8 Display Line with Annotations (SA mode shown, but others are similar)



How to create and move a Display Line

- Press **Limit 8**
- Then **Display Line OFF ON**
- Then enter a Y-axis value using the **▲▼** arrows or the rotary knob, then press **Enter**. Or enter a value using the numeric keypad and press a suffix key or press **Enter**.

All about Trace Math

Trace Math is available in **CAT** (excluding DTF measurements), **NA** Mode, and FOPS (under USB Power Meter mode).

NOTE

Noise Figure (NF–Opt. 356) does not have trace math, but does have the ability to display data and memory traces. Refer to “**How to display data and memory traces**”.

A trace is a series of measurement data points that are connected to form a line. This ‘live’ data trace is updated as data points are measured.

A memory trace is a live trace that has been stored in the FieldFox volatile memory. It then becomes static, meaning it is not updated with measurements. It can be displayed on the screen by itself, or with a data trace for comparison purposes.

- In NA mode, memory traces are the same color as data).
- In CAT mode and FOPS, the data trace is displayed in **yellow** and the memory trace is displayed in **blue**.

How to display data and memory traces

- Press **Trace 6**.
- Press **Math and Memory** then **Data->Mem** to store the current live trace into memory. A ‘beep’ sounds to confirm the data trace has been saved to memory. There is no display annotation that indicates that the memory trace has been stored.
 - Press **Data** to view only the data trace.
 - Press **Memory** to view only the memory trace.
 - Press **Data & Memory** to view both the live trace and the stored memory trace.

How to perform Trace Math

Trace math is performed between a live trace and a memory trace. When one of the following math operations are selected, the yellow data trace displays the current measurement with the selected trace math applied. The math operation symbol indicated below in [brackets] is displayed on the lower left corner of the screen.

- Press **Trace 6**.
- If not already stored, press **Data->Mem** to store the current live trace into memory.
- Then **Data Math**.
- Then choose one of the following:
 - **Data + Mem** [D+M] Current measurement data is added to the data in memory.
 - **Data – Mem** [D-M] Current measurement data is subtracted from the data in memory.

- **Data / Mem** [D/M] Current measurement data is divided by the data in memory.
- **Math Off** [Data] Displays trace data with NO math applied.

About Math Operations

Data / Memory and **Data - Memory** math operations are performed on complex linear data before it is formatted. Because data is often viewed in log format, it is not always clear which of the two math operations should be used. Remember: dividing linear data is the same as subtracting logarithmic data. The following illustrates, in general, when to use each operation.

Use **Data / Memory** for normalization purposes, such as when comparing traces “before” and “after” a change is made or when measuring trace noise. In the following table, the Data/Mem values intuitively show the differences between traces. It is not obvious what Data-Mem is displaying.

Values to compare	Data/Mem	Data-Mem
0.5 dB and 0.6 dB	0.1 dB	-39 dB
0.5 dB and 0.7 dB	0.2 dB	-33 dB

Use **Data - Memory** to show the relative differences between two signals. Use for comparison of very small signals, such as the S11 match of two connectors.

In the following table, Data/Mem shows both pairs of connectors to have the same 2 dB difference. However, the second pair of connectors have much better S11 performance (-50 and -52). The relative significance is shown in **Data-Mem**.

Values to compare	Data/Mem	Data-Mem
-10 dB and -12 dB	2 dB	-24 dB
-50 dB and -52 dB	2 dB	-64 dB

All about Scale Settings

How to Use Scale Settings

Adjust the Y-axis scale to see the relevant portions of the data trace. The Y-axis is divided into 10 graticules.

This setting can be changed at any time without affecting calibration accuracy.

How to set Scale

- Press **Scale / Amptd**.
- Then choose from the following three methods:
 1. **Autoscale** Automatically adjusts the Y-axis to comfortably fit the Minimum and Maximum amplitude of the trace on the screen.
 2. Set Scale, acquisition, and Reference Position:
 - **Scale** Manually enter a **scale per division** to view specific areas of the trace
 - **Ref Level** Manually set the value of the reference line. Enter a negative value by pressing **Run/Hold (+/-)** either before or after typing a value
 - **Ref Pos** Manually set the position of the reference line. Values must be between **0** (TOP line) and **10** (BOTTOM line)
 3. Set Top and Bottom graticule values. The scale per division is calculated.
 - **Top** to set the value of the Top graticule.
 - **Bottom** to set the value of the Bottom graticule.
 - Enter a negative value by pressing **Run/Hold (+/-)** either before or after typing a value.

Scale annotation on the FieldFox screen

Reference Line = red arrow

Ref Level = -40 dB

Ref Position = 1

Scale = 2 dB per division

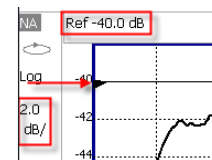

Averaging (CAT, NA, Power Meter, Channel Scanner, and Pulse Measurement Modes Only)

Trace Averaging helps to smooth a trace to reduce the effects of random noise on a measurement. The FieldFox computes each data point based on the average of the same data point over several consecutive sweeps.

Average Count determines the number of sweeps to average; the higher the average count, the greater the amount of noise reduction.

An average counter is shown in the left edge of the screen as **Avg N**. This shows the number of previous sweeps that have been averaged together to form the current trace. When the counter reaches the specified count, then a 'running average' of the last **N** sweeps is displayed. Average Count = 1 means there is NO averaging.

This setting can be changed at any time without affecting calibration accuracy.

NOTE

Averaging is often used to increase the dynamic range of a measurement. To achieve the highest dynamic range, select NA mode and reduce the IF Bandwidth setting. Learn more about dynamic range in ["Increase Dynamic Range" on page 105](#).

How to set Trace Averaging

- Press **BW 2**.
- Then **Average N** where **N** is the current count setting.
- Enter a value using the numeric keypad. Enter 1 for NO averaging.
- Press **Enter**.
- While Trace Averaging is in process, press **Sweep 3** then **Restart** to restart the averaging at 1.

Data Analysis Features
All about Scale Settings

25 System Settings

In this Chapter

- “Run/Hold” on page 464
- “Preset” on page 465
- “User Preset” on page 465
- “Audio (Volume) Control” on page 466
- “Display (Settings)” on page 467
 - “Display Brightness” on page 467
 - “Display Colors” on page 467
 - “Trace Width” on page 468
 - “Title” on page 468
 - “Edit Keywords” on page 469
 - “Full Screen Mode” on page 469
- “Preferences” on page 469
 - “Quick Settings Table” on page 469
 - “Save and Reset Preferences” on page 470
 - “Global Settings (Overview)” on page 471
 - “Language” on page 471
 - “Battery Saver” on page 472
 - “Startup Mode” on page 473
 - “File folders” on page 476
 - “Alpha Numeric Editing” on page 477
 - “File Saving Naming Options” on page 477
- “System Configuration” on page 479
 - “Options (Licensing)” on page 479
 - “GPS” on page 480
 - “Frequency Reference Source” on page 484

“Variable Voltage Source (Opt. 309)” on page 485

“Security Level” on page 486

“Date and Time, Format, and Time Zone Settings” on page 487

“LAN Settings” on page 488

“Power ON” on page 490

“FieldFox Package Installer (N995xA, N996xA, and applies to: N991xA/2xA/3xA units with serial number prefixes ≥ 5607)” on page 491

“Date and Time, Format, and Time Zone Settings” on page 487

“Service Diagnostics” on page 493

See Also:

“Install the Lithium-Ion Battery” on page 26



“FieldFox High Temperature Protection” on page 28

Run/Hold

The **Run/Hold** key determines whether the FieldFox sweeps continuously or does NOT sweep, but holds the display results of the last sweep that was performed.

Use **Hold** to conserve battery power or to allow you to save or analyze the results of a specific measurement sweep.

The current sweep mode is shown on the screen as:

-  Continuous
- Hold
-  is displayed while a single sweep occurs.

How to perform a single sweep while in Hold

- Press **Sweep 3**.
- Then choose one of the following:
 - **Single** Automatically sets Continuous OFF (Hold) and causes FieldFox to make ONE measurement sweep, then hold for the next Single key press.
 - **SA Mode ONLY** – With **Continuous OFF** each successive **Run/Hold** press also causes a single sweep.

System Settings
Preset

- **Continuous ON OFF** Makes continuous sweeps. This is the typical setting when battery power is not critical.

Preset

The Preset key restores the FieldFox measurement settings to a known condition. You can preset the entire instrument, or just the current Mode (CAT, SA, and so forth).

When Preset, the FieldFox CalReady calibration is recalled for use in CAT and NA Modes. Learn more in [“CalReady” on page 121](#).

In addition to all **Preference** settings, the following settings always survive Preset and Mode Preset:

- External Reference state (see [“Frequency Reference Source” on page 484](#))
- SA Scale and Units (see [“Scale and Units” on page 151](#))
- SA Correction states (see [“Field Strength Measurements” on page 154](#))
- VVM Display Resolution (see [“Display Resolution” on page 336](#))
- Marker Peak Excursion and Threshold (see [“What Is a ‘Peak’” on page 449](#))

How to Preset the FieldFox

- Press **Preset**.
- Then choose one of the following:
 - **Preset** Returns ALL Modes to the factory default settings.
 - **Mode Preset** Returns only the current Mode to the factory default settings. The current settings for all other Modes remain.

User Preset

User Preset allows you to store custom settings for each mode, then recall the settings when the Preset key is pressed. Your custom settings are saved to a standard State file (UserPreset.sta). However, unlike State files, calibration data is NOT saved. Learn more about State files in [“Set File Type and Select Device” on page 503](#).

How to set User Preset

- Make your custom settings for all modes.
- When finished, press **Preset**.
- Then **Save User Preset**, then select **Yes** to confirm.

- Then **User Preset ON**

How to recall User Preset

- Press **Preset**.
- Then choose from the following:
 - **Preset (User)** The entire UserPreset.sta file is recalled. ALL modes assume the settings that were in place when the User Preset was saved. The active mode is the mode that was visible when the file was saved.
 - **Mode Preset (User)** The settings for only the current mode are recalled from UserPreset.sta.

NOTE

- Only the instrument settings are saved to UserPreset.sta. No trace data or calibration data is saved.
- User Preset ON / OFF is saved as a Preference setting. Like all preferences, this setting survives a FieldFox shut down and power ON. Therefore, when User Preset is ON during shut down, the FieldFox will load UserPreset.sta when it is powered ON.
- To return to Factory Preset, select **User Preset OFF**. The contents of UserPreset.sta remain stored on the FieldFox. When User Preset is OFF, you can also set the Startup Mode preference that determines which mode will be visible after powering ON. Learn more in [“Startup Mode” on page 473](#).

Audio (Volume) Control

System volume control is a FieldFox global setting which sets speaker volume for ALL success beeps, key press clicks, and individual features that use the FieldFox speaker, such as SA Mode Tune and Listen.

The volume control setting remains through a FieldFox Preset. To cause your volume control setting to remain through a FieldFox shut down, save the setting as a Preference. Learn how in [“Save and Reset Preferences” on page 470](#).

How to set the FieldFox Volume Control

- Press **System 7**
- Then **Volume**
- Then use the  arrows, the rotary knob, or numeric keypad to enter a value between 0 (lowest volume) and 100 (highest volume).

System Settings
Display (Settings)

- Press **Volume** again and select Mute to quickly turn OFF the speaker volume.
- Press **Volume** again to set volume ON to the previous volume control.

Display (Settings)

You can adjust the FieldFox for optimum viewing in a wide range of lighting conditions.

Display settings are persistent after a FieldFox shut down. Save the display settings as Preferences. Learn how in [“Save and Reset Preferences” on page 470](#).

NOTE

Clean the transfective screen with gentle and minimal wiping using Isopropyl alcohol applied to a lint-free cloth.

Display Brightness

Change the brightness of the background.

How to set Display Brightness

- Press **System 7**
- Then **Display**
- Then **Brightness**
- Use the  arrows, the rotary knob, or numeric keypad to enter a value between 0 and 100%.

Display Colors

Change Display Colors to alter the viewing scheme.

How to set Display Colors

- Press **System 7**
- Then **Display**
- Then **Display Colors**
- Then choose one of the following:

Indoor



System Settings
Display (Settings)

Outdoor Dusk



Outdoor Clouds



Outdoor Sun



Night Vision



Trace Width

You can set width of all displayed traces on the FieldFox. This may allow better viewing or enhance the look of screen images. This setting can be saved with Preferences.

How to set Trace Width

- Press **System 7**
- Then **Display**
- Then **Display Colors**
- Then **More**
- Then **Trace Width**
- Then choose one of the following:
 - **Normal** - Standard width.Wide
 - **Wide** - Enhanced width

Title

A custom title can be made to appear in the upper-left corner of the FieldFox screen. The title can contain up to approximately 65 alpha-numeric characters. To view the Title area, see the Screen Tour in **“Screen Tour” on page 39**.

How to add or edit a Title

- Press **System 7**
- Then **Display**
- Then **Title**

System Settings Preferences

- Then enter or edit a title using the FieldFox labeler. This is the same labeler function that is used to name files. Learn how to use the labeler in [“How to use the FieldFox labeler” on page 500](#).
- Then **Title ON OFF** to make the title appear and disappear from the screen.

Edit Keywords

During a file save operation, keywords can be quickly appended to other text to create unique filenames. The Edit Keywords feature allows you to create custom keywords. Learn all about Edit Keywords in [“Edit Keywords” on page 509](#).

Full Screen Mode

Full Screen Mode maximizes the display of trace. The screen annotations and the soft keys are removed.

- Press **System 7**
- Then **Full Screen**

To **Exit** full screen Mode, press any key.

Preferences

FieldFox preferences are settings that survive a shut down. When your FieldFox is turned OFF, then back ON, these settings remain. All preference settings can be restored to their factory defaults. Learn how in [“Save and Reset Preferences” on page 470](#).

There are two ways to make FieldFox preference settings:



- From softkey selections throughout the FieldFox menu structure. Do this to temporarily try a setting, then press **Save Current Preferences**. Learn how in the next section.
- From the Quick Settings table.
- Also, refer to: [“Audio \(Volume\) Control” on page 466](#) and [“Display \(Settings\)” on page 467](#).

Quick Settings Table

All preferences can be set from the Quick Settings table. They are immediately saved as Preferences when **Done** is pressed.

How to view and change Preference Quick Settings

- Press **System 7**
- Then **Preferences**

- Then **Preferences**
 - Press **Next Page** and **Previous Page** to view all settings.
 - To change a setting:
 - Use the  arrows to highlight a setting.
 - Then press **Edit**. The current setting changes to **yellow**.
 - Some settings require you to press a softkey to change the value. Otherwise, use the numeric keypad,  arrows, or rotary knob to change the value.
 - When finished changing a value, press **Done Edit**.
 - When finished changing ALL preferences, press **Done**. All changes are immediately saved as Preferences.
 - To exit the editing session without saving changes, press **Esc** at any time.
- Learn more about these preference settings:

Settings

“Global Settings (Overview)” on page 471

- **“Language” on page 471**
- **“Battery Saver” on page 472**
- **“Startup Mode” on page 473**

“Display (Settings)” on page 467

“Audio (Volume) Control” on page 466 and “Audio” on page 474

“Date and Time” on page 475

“GPS” on page 480

“File folders” on page 476

“Alpha Numeric Editing” on page 477 (i.e., ABC/Qwerty keyboard styles)

“File Saving Naming Options” on page 477

“CAT (Distance Units)” on page 477

“CAT/NA” on page 478

“SA” on page 479

Save and Reset Preferences

All preference settings can be made at one time from the Quick Settings table.

All settings that can be saved as preferences (except Battery Saver and Startup Mode) can also be made from individual softkey selections throughout the FieldFox menu structure. However, they remain through a FieldFox shut down ONLY when the current settings are saved as preferences.

The table above shows a list of all of these settings and where they are discussed in this User's Guide.

How to save current settings as Preferences

- Using softkeys, configure the settings as you would like them to remain.
- Press **System 7**
- Then **Preferences**
- Then **Save Current Settings** There is a beep when your settings have been saved.
- Press **Reset Preferences** to restore the factory default settings.

Global Settings (Overview)

Choose the Global Settings values (Language, Batter Saver, and Startup Mode). See also [“Quick Settings Table” on page 469](#).

How to select Global Settings:

- Press **System 7**
- Then **Preferences**
- Then **Preferences**
- Then use arrow softkeys or the knob to select Global Settings
- Then **Edit** for each of the following:
 - Language (see)
 - Batter Save Mode (see)
 - On
 - Off (default)
 - Startup Mode (see)
- Then **Done Edit** (for each change in setting)

Language

Choose the language in which to display FieldFox softkeys and other messages. Select Save Current Settings to set this language as a preference.

How to select a Language

- Press **System 7**
- Then **Preferences**
- Then **Language**
- Then choose from the following:
 - **English**
 - **Espanol – Spanish**
 - **Deutsch – German**
 - **Italiano – Italian**
 - **Francais – French**
 - **Russian**
 - **Japanese**
 - **Chinese**
 - **Turkish**

Battery Saver

When the battery saver is OFF, the RF source power is left ON at the end of the sweep which consumes more battery power. This feature is used in CAT, NA, VVM modes, and SA mode when the internal source is turned ON.

Battery Saver is the ONLY FieldFox setting that must be made as a Preference from the Quick Settings table. This setting remains until you change it again.

NOTE

The FieldFox internal temps will run 2°C – 5°C cooler with the Battery Saver on (the temperature range is dependent on the ambient temp).

How to set Battery Saver

- Press **System 7**
- Then **Preferences**
- Then **Preferences**
- Then scroll to **Global Settings > Battery Saver**
 - **ON** – To conserve battery power, the RF source power is turned OFF at the end of each CAT, NA, and VVM mode sweep. This behavior does not impact FieldFox measurements.
 - **OFF** – Source power is kept ON at all times, including during trigger Hold mode and between single sweep acquisitions. The RF source stays at the stop frequency until another sweep begins. This provides

a constant, uninterrupted RF output from the RF OUT port. This behavior also provides the highest trace stability sweep-to-sweep which may only be evident while using either single sweep or Run/Hold. With Battery Saver OFF, the use of a full battery charge is reduced by approximately 45 minutes.

Startup Mode

The Startup Mode setting determines the mode that becomes active (visible) when User Preset is set to OFF (Factory Preset) and the FieldFox is powered ON. See [“User Preset” on page 465](#).

How to setup Startup Mode

- Press **System 7**
- Then **Preferences**
- Then **Preferences**
- Then scroll to **Global Settings > Startup Mode** and press **Edit**.
- Then repeatedly press the **Startup Mode** to scroll through the available choices.
 - **<Default>** is the factory default mode for your FieldFox model.
 - Built-in Power Meter Mode is NOT allowed as a Startup Mode.

Display

Choose the Display values (Display Colors, Trace Width, Brightness, Title Enabled, Title). See [“Display \(Settings\)” on page 467](#).

How to select Display values:

- Press **System 7**
- Then **Preferences**
- Then **Preferences**
- Then use arrow softkeys or the knob to select **Display**
- Then **Edit** for each of the following:
 - Display Colors
 - Indoor (default)
 - Night Vision
 - Outdoor Sun
 - Outdoor Dusk

System Settings
Audio

- Outdoor Clouds
- Trace Width
 - Normal (default)
 - Wide

NOTE

Setting trace width to **Wide**, will result in slower trace refresh rates.

-
- Brightness
 - 0 to 100% (80% default)
 - Title Enabled
 - On
 - Off (default)
 - Title
 - User Title (default)
 - Then **Done Edit** (for each change in setting)

Audio

Choose the Audio values (Mute, Volume). See also **“Audio (Volume) Control” on page 466**.

How to select Audio values:

- Press **System 7**
- Then **Preferences**
- Then **Preferences**
- Then use arrow softkeys or the knob to select **Audio**
- Then **Edit** for each of the following:
 - Mute
 - On
 - Off (default)
- Volume
 - 0 to 100 (default is 50)
- Then **Done Edit** (for each change in setting)

Date and Time

Choose the Date and Time values (Date and Time, Time Format, Date Format, and Time Zone). See also [“Date and Time, Format, and Time Zone Settings” on page 487](#).

How to select CAT distance units:

- Press **System 7**
- Then **Preferences**
- Then **Preferences**
- Then use arrow softkeys or the knob to select **Date and Time**
- Then **Edit** for each of the following:
 - Date and Time
 - Edit as needed (Refer to [“Date and Time, Format, and Time Zone Settings” on page 487](#)):
 - Time Format
 - Date Format
 - Time Zone
- Then **Done Edit** (for each change in setting)

GPS

Choose the GPS values (GPS State, Elevation Unit, GPS Sync Clock, Display, Lat/Lon Format). See also [“GPS” on page 480](#).

How to select CAT distance units:

- Press System 7
- Then Preferences
- Then Preferences
- Then use arrow softkeys or the knob to select **GPS**
- Then Edit for each of the following:
 - GPS State
 - Off (default)
 - Internal
 - External

System Settings
File folders

- Elevation Unit
 - Meters (default)
 - Feet
 - Inches
- GPS Sync Lock
 - Off (default)
 - Internal
 - External
- Display
 - On
 - Off
- Lat/Lon Format
 - ddd° mm' ss.sss"
 - ddd.dddddd°
 - ddd° mm.mmmmm'
- Then Done Edit (for each change in setting)

File folders

When enabled, FieldFox uses the last selected Device and Folder location as the default device location after instrument power cycle.

NOTE

Before setting the preferences for the File Folders, you must select the Device and Folder locations. Refer to [Chapter 27, "File Management."](#)

How to set File Folders

- Press **System 7**
- Then **Preferences**
- Then **Preferences**
- Then scroll to User Folder Persist:
 - **User Folder Persist (On/Off)** – Defaults to the current Device and folder location at power up. Toggle User Folder Persist On/Off when a new Device location is selected location.
 - **User Folder** – displays the default folder location.

- **User Device** – displays the default device location.

See also: “[Alpha Numeric Editing](#)” and “[File Saving Naming Options](#)”.

Alpha Numeric Editing

- **Keyboard Style** – Toggles through Qwerty/ABC style keyboards that the Labeler displays. Refer to “[How to use the FieldFox labeler](#)” on page 500.

File Saving Naming Options

- **Prefix** – Displays the current choice for Prefix. Choices are User, Last File (default), or Off. Refer to Prefixes and Suffixes for Filenames in “[Prefixes and Suffixes for Filenames](#)” on page 509.
- **Auto Append** – Displays the current choice for Auto Append to a filename (Suffix). Choices are Off (default), Number, Date. Refer to “[Prefixes and Suffixes for Filenames](#)” on page 509.

CAT (Distance Units)

Choose the CAT distance units (i.e., Meters (default), Feet, Inches). See “[DTF Units](#)” on page 67.

How to select CAT distance units:

- Press **System 7**
- Then **Preferences**
- Then **Preferences**
- Then **Edit** for each of the following:
 - Distance Units:
 - Meters (default)
 - Feet
 - Inches
 - TDR Sweep:
 - Cable (default and the most accurate)
 - Auto
- Then **Done Edit** (after each change in setting)

CAT/NA

Choose the CAT/NA settings for SnP file save, default factory error corrections, extended cal default. See also “> **What Data Processing functions are included in saved SNP Data:**” on page 505.

How to select CAT/NA defaults:

- Press **System 7**
- Then **Preferences**
- Then **Preferences**
- Then use arrow softkeys or the knob to select CAT/NA
- Then **Edit** for each of the following:
 - SnP File Save
 - Default
 - Advanced
 - Default Factory Error Corr. (N995xA/6xA Only)
 - Enhanced Response
 - Full 2 Port
 - Extended Cal Default (N995xA/6xA Only)
 - On
 - Off (default on models >6 GHz)
- Then **Done Edit** (after each change in setting)

SA

Choose the SA setting for Individual ment Control default. See also [“Alignments” on page 177](#).

How to select SA defaults:

- Press **System 7**
- Then **Preferences**
- Then **Preferences**
- Then use arrow softkeys or the knob to select SA
- Then **Edit** for each of the following:
 - Individual ment Control
 - On (Default - recommended)
 - Off
- Then **Done Edit** (after changing setting)

System Configuration

Options (Licensing)

You can view and install options on your FieldFox. To see a comprehensive list of the options that are available, view the FieldFox Configuration Guide at: <http://literature.cdn.keysight.com/litweb/pdf/5990-9836EN.pdf>

How to view the Installed Options

- Press **System 7**
- Then **System Configuration**
- Then **Options (Licensing)**
- Then **Show Options**

The currently installed options are listed.

How to Install Options

A.lic file must already be on a USB Flash Drive. To learn how to obtain a.lic file, visit: <http://www.keysight.com/find/softwarelicense>

Insert the USB Flash Drive in the FieldFox.

- Press **System 7**
- Then **System Configuration**

- Then **Options (Licensing)**
- Then **Install Options** The FieldFox reads, validates, then installs the options.
- Press and hold the power button to shut down, then restart the FieldFox.

How to Delete ALL Options

Deleting individual options is NOT supported.

- Press **System 7**
- Then **System Configuration**
- Then **Options (Licensing)**
- Then **Advanced**
- Then **Delete All Options**

After a warning message, all options on the FieldFox are deleted.

NOTE

Delete All CFG Options is to be used by Service Personnel ONLY.

For more information about Licensing, see the FieldFox Service Manual at:
<http://na.support.keysight.com/fieldfox>.

GPS

GPS (Global Positioning System) allows you to ‘stamp’ each data trace with your physical position in latitude/longitude/elevation format. This can be useful when making measurements on cell towers or other antennas at remote locations.

- **With Option 307**, GPS is available with the built-in receiver accessed through the top-panel SMA (f) connector. This connector has a 3.3 VDC bias voltage which is switched ON when GPS is set to Internal. This system is designed for use with an active antenna such as the Keysight N9910X-825.
- **Without Option 307**, GPS is usable ONLY with an external GPS receiver that is shipped with Microsoft “Streets and Trips” and “AutoRoute”. The GPS receiver is NOT available from Keysight. Only the GPS USB receiver is used with the FieldFox. Therefore, it is NOT necessary to purchase the very latest version of the map software.

How to make GPS settings

GPS settings are the same with, or without, Option 307.

- Your GPS settings can be saved with Preferences. Learn more in “**Quick Settings Table**” on page 469.
- Press **System 7**

- Then **System Configuration**
- Then **GPS**
- Then choose from the following:
- **Display ON OFF** Enable and disable the GPS display on the FieldFox main window.
- **GPS**
 - **OFF** - Disable GPS (default setting).
 - **External** - Enable GPS using an external, customer-supplied, USB dongle device. A check is made to detect a USB GPS device at the USB connectors.
 - **Internal** - Enable GPS using Option 307 – Built-in GPS. Connect a GPS antenna to the top-panel GPS connector. Learn more about additional GPS antenna accessories at <http://www.keysight.com/find/fieldfox>. Internal is set automatically when Frequency Reference Source is set to GPS. Learn more in **“Frequency Reference Source” on page 484.**

When Internal or External is selected, a search is made for satellites overhead. GPS works best when outdoors and in full view of the open sky. When several satellites are found, the following screen appears (when Display is set to ON) and is updated frequently:

NOTE

As the bar graph count exceeds 9 bars, the “dB” text is dropped from the number displayed on the bar. Units for C/No are dBHz.

Figure 25-1

GPS Display

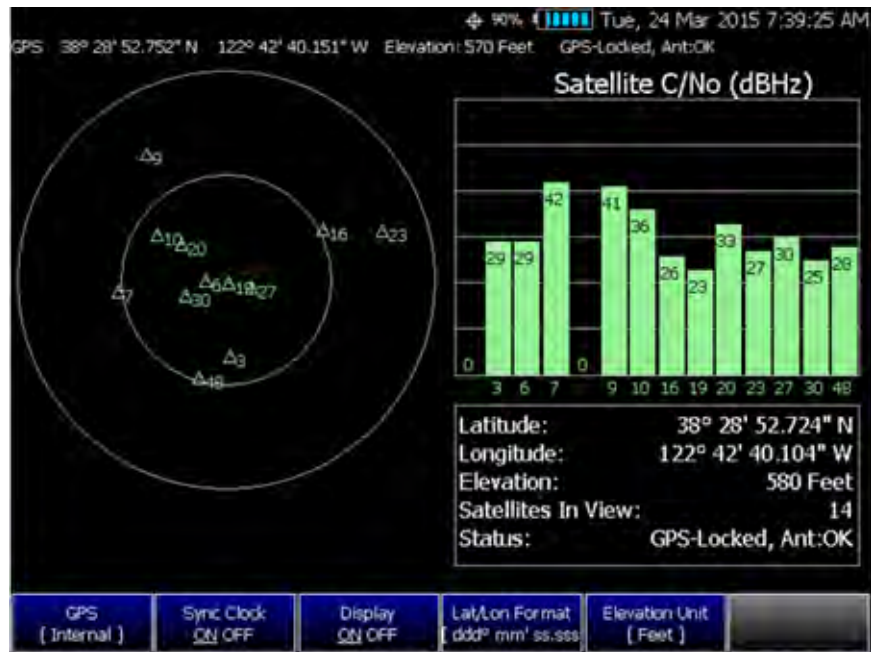

- The left portion of the screen displays satellites and the corresponding number on the adjacent Satellite Power chart.
- The right portion of the screen displays Satellite Power Carrier to Noise (C/No) dBHz values on the tops of the satellite power chart.

NOTE



The C/No values returned are not calibrated at the factory or warranted for accuracy. The numbers retrieved are passed unprocessed directly from the GPS receiver in use.

GPS Status

With GPS enabled the following is displayed at the top of the FieldFox screen:



The following icons (located in RED circle above) indicate the GPS lock status:

-  - GPS ON and locked on satellites.
-  - GPS ON, but NOT locked on satellites.
-  - GPS ON, but no GPS receiver is present or detected.

The following annotation (BLUE circle in above image) indicates the **INTERNAL**, top-panel antenna status:

- Ant: **INIT** – antenna status initializing.

- Ant: **OK** – antenna present and working.
- Ant: **OPEN** – antenna is not drawing DC bias current. This could occur when an active antenna is not connected properly or the antenna does not require DC bias current. Antennas that do not require bias current can still provide an accurate GPS reading.
- Ant: **SHORT** – antenna center pin has been shorted to ground. The internal bias circuitry is disabled for about one minute, then re-enabled. You can also press **GPS OFF**, then **GPS Internal** to quickly re-enable the antenna bias.

More GPS settings

- Press **System 7**
- Then **System Configuration**
- Then **GPS**
- Then choose from the following:
- Enable and disable the synchronization of the FieldFox internal clock to the GPS UTC time standard.

NOTE

The GPS Sync setting has the same restrictions as the Date and Time setting. Learn more in [“Date and Time” on page 475](#).

- **ON** The FieldFox clock is synchronized and updated approximately once every hour to the time of the GPS clock.
- **OFF** The FieldFox clock is NOT synchronized with GPS. When set to OFF after Sync was ON, the date and time does NOT revert back to the settings before the clock was synchronized.
- **Lat/Lon Format** Change the format of the GPS display on the FieldFox screen. Choose from:
 - **ddd°mm’ ss.sss”** degrees, minutes, seconds (default setting)
 - **ddd°mm.mmmmm’** degrees, minutes, fractional minutes
 - **ddd.dddddd°** decimal degrees
- **None** Lat/Lon is not displayed.
- **Elevation Unit** Choose from:
 - **m** (Meters)
 - **Feet**
 - **Inches**

Saving Data with GPS Enabled

GPS position and clock data are included when data is saved with the following files types: *.csv, *.SnP, State, State+Trace data save.

A warning is shown if the GPS is ON but unlocked at time of save, or if the GPS feature is ON but no GPS is physically present at time of save.

The following is a sample S1P file with GPS information:

```
!GPS Latitude: 38 28.87717 N
!GPS Longitude: 122 42.66625 W
!GPS TimeStamp: 06/25/2010 16:24:48
!GPS Seconds Since Last Read: 2s
```

Frequency Reference Source

The FieldFox internal frequency reference source is used to make accurate and stable measurements. To improve measurement accuracy and stability, you can use a highly-stable external 10 MHz reference source or a precision timing signal provided with Built-in GPS (Opt. 307).

The Frequency Reference setting will survive a Factory Preset or Mode Preset and is saved as part of the Instrument State. When resuming after Standby, the FieldFox will display an Unlock message while it acquires a lock to an external or GPS source.

How to select Frequency Reference Source

- Press **System 7**
- Then **System Configuration**
- Then **Frequency Ref**
- Then **Freq Ref Source**
- Then choose from the following:
 - **Int** Internal frequency reference
 - **Ext** External frequency reference. Connect the 10 MHz External Reference to the **Ref In/Trig** In SMA (f) connector on the FieldFox top panel. The FieldFox may take up to 10 seconds to lock to a valid External Reference source
 - **GPS** Available ONLY with Built-in GPS (Opt. 307). When selected, the internal GPS is immediately enabled and a search for satellites begins. When satellites are found, the precision timing signal is NOT used directly, but is used to correct the absolute frequency of the internal reference many times per second.

Hold-over mode

When the GPS signal is lost, the last GPS reading is used as a hold-over correction value for the internal reference. The hold-over correction value is no longer used, but instead the factory-set correction value is used, when any of the following occur:

- when GPS is disabled.
- when Reference Source is set to Internal.
- when the FieldFox resumes from Standby mode or shut down.

Frequency Reference Status

When switched to **Ext** or **GPS**, one of the following annotations appears in the lower-left corner of the screen:

- **EXT R** – External reference is selected.
- **GPS R** – GPS reference is selected.
- **GPS H** – Internal Reference is used with last ‘hold-over’ correction reading.

If the FieldFox does NOT find an appropriate **Ext** or **GPS** reference signal, then **Ext Ref UNLOCKED** is displayed in the lower-left corner of the graticule area.

This can occur when any of the following conditions exist:

- NO reference signal is present.
- A low or very high-level external reference signal is present. For best results, the signal should be between -5 dBm and $+5$ dBm.
- The external reference is off-frequency.

To learn the expected measurement accuracy when connected to a frequency reference source, see the FieldFox specifications in **“Specifications/Data Sheet” on page 541**.

Reference OUT

The internal 10 MHz frequency reference is available from the Ref/Trig output connector on the right-side panel. Use this signal as a common frequency reference when making measurements using external equipment. See this connector in **“Top Panel” on page 36**.

Variable Voltage Source (Opt. 309)

An internal DC source, available with Opt. 309, may be used to provide power for external devices. The maximum power available is 8 watts.

The voltage is output through an SMB (m) output connector located on the left-side panel. See the connector in **“Left Side Panel” on page 38**.

An optional SMB (f) to BNC (m) bias-tee power cable is available with Keysight part number: N9910X-713.

The following status line is provided near the top of the FieldFox screen.

Figure 25-2

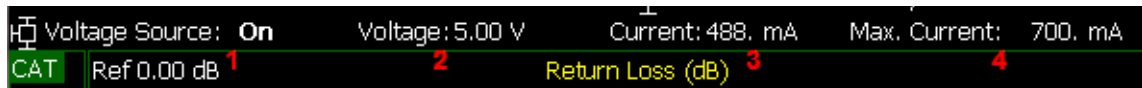

Voltage Source Status Line

1. Voltage source state: ON, OFF, TRIPPED.
2. **Voltage** setting from 1.00 V to 32.00 V with.01 V resolution.
3. **Current**: The amount of current (in Amperes) being drawn from the source.
4. **Max Current**: A conservative estimate of maximum current possible given the present voltage setting. The actual 'trip' level may be slightly different.

How to make Voltage Source settings

- Press **System 7**
- Then **System Configuration**.
- Then **Voltage Source**.
- Then **Source ON OFF** to enable and disable the voltage source output.
- Then Voltage x.xx V Using **▲▼** arrows, the rotary knob, or numeric keypad, enter a value between 0.001 and 32 volts.
- **Clear Overload** If the voltage source becomes 'TRIPPED' press to re-enable the voltage source output. Then set **Source ON**.
- **Status Line ON OFF** Turn ON and OFF the voltage source status line that appears near the top of the screen. The status line is always ON while making Voltage Source settings.

Security Level

For security reasons, you can prevent frequency information from appearing on the FieldFox while in SA, NA, or CAT modes.

How to set Security Level

- Press **System 7**
- Then **System Configuration**
- Then **Security Level**
- Then choose from the following:

- **None** All frequency settings are visible.
- **High** Frequency information is blanked from the following:
 - Display annotation
 - Softkeys
 - Marker display and marker table
 - Calibration properties
 - All settings tables
 - Limit line tables
 - All saved.png files
- Any of the following will re-display frequency information:
 - Set to **None**, Preset, Mode Preset, or FieldFox restart.

Date and Time, Format, and Time Zone Settings

Set the local date and time, Date and Time format, and Time Zone that is shown on the FieldFox screen. The Date and Time is also used to identify files that are saved.

The Date and Time can also be set by synchronizing with GPS satellites. Learn more in [“GPS” on page 475](#).

How to Update Date and Time using Internet

This method of setting the Date and Time does NOT have the security restrictions of the other methods (listed below).

This method will NOT set the correct Time Zone. You must do that using the manual method. See below.

- Press **System 7**
- Then **System Configuration**.
- Then **More**
- Then **Update Time using Internet**
- Connect a LAN cable that is also connected to the Internet.
- Then press **Update Time using Internet**. When successful, a message is displayed indicating the amount of time correction that occurred.
- Optional: Set the following when a Proxy server is used to connect to the internet:
 - **Proxy Host** – Enter the name of the proxy host.
 - **Proxy Port** – Enter the port number of the proxy host.

How to MANUALLY set Date and Time, Format, and Time Zone

NOTE

Because of licensing security, the manual and GPS Sync methods to set Date and Time are restricted as follows:

Can be set backward no more than 5 hours at a time.

Can be set forward any amount of time.



Can be set backward or forward no more than once in a day. A new day begins at midnight.

There is no restriction for setting the Time Zone.

To change the Date and Time backward a significant amount, send an email to ctd-soco_support@keysight.com.

NOTE

BEFORE manually setting the Date and Time, be absolutely certain that the Time Zone setting is correct.

- Press **System 7**
- Then **System Configuration**.
- Then **More**.
- Then **Date and Time**.
- Press the  arrows to highlight the row to be edited.
- Then press **Edit**.
- Use the  arrows or rotary knob to select the field to be edited.
- Use the  arrows or numeric keypad to edit that field.
- Press **Cancel** or **Done** when the edits are complete.
- Press **Done** to exit the Date and Time settings. The readout in the upper-right corner of the FieldFox screen will update accordingly.

LAN Settings

Configure the LAN settings to be used to communicate with the Data Link Software and connect to the FieldFox for remote SCPI operation. Learn more about Data Link at: www.keysight.com/find/fieldfoxsupport.

Use knob. Press [Edit] to make changes. Press [Done] to exit.	
Setting	Value
Current IP Address	192.168.1.102
Current Subnet Mask	255.255.255.0
Current Gateway	192.168.1.1
Hostname	A-N9912A-00000
Obtain IP Address using:	DHCP
Static IP Address	123.456.789.123.123
Static Subnet Mask	0.0.0.0
Static Gateway	0.0.0.0
Apply Settings at:	PowerUp

Table 25-1 LAN LEDs (N995xA, N996xA, and applies to: N991xA/2xA/3xA units with serial number prefixes ≥ 5607)

LAN LEDs (N995xA, N996xA, and applies to: N991xA/2xA/3xA units with serial number prefixes ≥ 5607)

When FieldFox is connected to the LAN, the flashing LAN LEDs have the following definitions:

Green: Flashing indicates packets are being transferred.

Yellow:

- Flash, pause = 10 Mbit link speed
- Flash, flash, pause = 100 Mbit link speed
- Flash, flash, flash, pause = 1 GBit link speed

How to configure LAN settings

The first three ‘Current...’ settings can NOT be edited.

- Press System 7.
- Then System Configuration.
- Then More.
- Then LAN.
- Use the  arrows to select one of the following, then press Edit.
- **Hostname** Change the name that can be used to address the FieldFox if your server supports this feature. The default hostname is generated automatically.
- **Obtain IP** Choose from:
 - **DHCP** - IP Address is assigned dynamically. If your server supports this feature, the IP Address for the FieldFox is assigned each time it is started.

- **Static** - Set the IP Address manually. The Address remains until you change it.
- **Static IP Address** - Enter the IP Address – including periods - in the format nnn.nnn.nnn.nnn

NOTE

For all FieldFoxes with firmware \leq A.08.25 and \leq A.09.50 FW, when using Static IP addresses:

- Either a valid Static Gateway is required or 0.0.0.0.
 - Either a valid Static DNS is required or 0.0.0.0. (If entry is available.)
-
- **Static Subnet Mask** - Enter the Subnet Mask – including periods - in the format nnn.nnn.nnn.nnn
 - **Static Gateway** - Enter the Static Gateway – including periods - in the format nnn.nnn.nnn.nnn
 - **Static DNS** - Enter the Static DNS – including periods - in the format nnn.nnn.nnn.nnn
 - **Apply Settings** Choose from:
 - **Power Up** The above settings take effect when the FieldFox is started.
 - **Now** The above settings take effect immediately.

NOTE

To make the LAN settings persist after power up, toggle Apply Settings to Now then back to Power Up. You should see a message indicating that the LAN config file was saved.

-
- Press **Done Edit** when finished.

Power ON

When the FieldFox is without a power source, this setting allows the FieldFox to power ON as soon as a charged battery or the DC Adapter is inserted without pressing the power button.

How to set Power ON

- Press **System 7**
- Then **System Configuration**
- Then **More**
- Then **Power ON**
- Then choose from the following:
 - **Auto** The FieldFox will power ON when a charged battery or the DC Adapter is inserted.

- [Manual](#) The FieldFox will power ON only when the power button is pressed.

FieldFox Package Installer (N995xA, N996xA, and applies to: N991xA/2xA/3xA units with serial number prefixes ≥ 5607)

The FieldFox Package Installer enables you to download new versions of firmware from either a USB memory or SD Card. Additionally, the Utility softkey enables you to backup user files or restore user files.

How to run the Installer

NOTE

Before running the Installer to update your firmware, you might want to back up your user data. Refer to [“How to restore files” on page 492](#).

- Press [System 7](#).
- Then [System Configuration](#).
- Then [More](#)
- Then [Firmware Update](#)
- Then [Start Installer](#)
- The Installer software opens after a couple of seconds.

NOTE

If no files are displayed, verify that a USB memory or SD Card is installed and press [Refresh List](#).

- Then the  arrows or the knob to scroll to the firmware you want to install.
- Press [Start Install](#)
- “Current Step Progress:” bar and a “Total Progress:” bar are displayed along with this message: “Copying package. Do not remove install media.”
- When the installation is completed, the FieldFox reboots.

How to backup files

This procedure backs up your user data to a USB or SD card. See also [“How to restore files” on page 492](#).

NOTE

If you backup multiple versions of the user files, the FieldFox appends a “_#” to each subsequently stored file. During restore, the file with the highest appended number is loaded into the FieldFox.

From the initial Installer menu:

- Press **Utility**
- Then **Backup Data**
- A message is displayed: “Choose backup file location.”
- Then choose either **SD Card** or **USB**
- A progress bar and a message is displayed: “Saving user data...”
- Press **Cancel** to exit without backing up your files and returning to the initial Installer menu.

How to restore files

This procedure restores user files from a USB or SD card. See also [“How to backup files” on page 491](#).

CAUTION

Restoring files overwrites the existing user data on the FieldFox.

NOTE

If you backup multiple versions of the user files, the FieldFox appends a “_#” to each subsequently stored file. During restore, the file with the highest appended number is loaded into the FieldFox

If you stored any user files to a USB or SD card, this procedure restores those files.

From the initial Installer menu:

- Press **Utility**
- Then **Cancel** to exit without restoring your files and returning to the initial Installer menu.

Or

Press **Restore Data**

- A message is displayed: “This option will COMPLETELY ERASE existing user data. ARE YOU SURE?”
- Then **No** to return to the previous menu without restoring files.

Or

Press **Yes**

- Then choose either SD Card or USB

A progress bar and a message is displayed: “Restoring user data...”

Service Diagnostics

- The Service diagnostics menu is generally used to display service-related information. To access these menu items, press **System 7** then **Service Diagnostics**.

System Information

The System information table shows important information about your FieldFox. The following is the most useful information:

- **Model Number** – FieldFox model
- **Serial Number** – Identification number of your FieldFox
- **Firmware Release** – The currently installed version of software. Check to see if you have the latest firmware at:
www.keysight.com/find/fieldfoxsupport
- **Network Identity** – The network name and current IP address of your FieldFox.
- **Reflectometer Factory Cal** - The Factory (CalReady) Calibration shows the date and time that the factory cal was performed for each test port and the Thru connection. The format is P1 <date time>, P2 <date time>, P1-P2 <date time>. The factory calibration is updated when you send your FieldFox to Keysight for Instrument Calibration. Learn more in “**Instrument Calibration**” on page 543.

Event Log

The Event Log shows the information that has appeared on the FieldFox screen. The most recent information is at the top of the table.

Press **Clear Events** to erase this information.

Battery

Learn more in **Chapter 28, “Working with the Lithium-Ion Battery”, on page 513.**

Internal Temperatures

Learn about the importance of the internal FieldFox temperatures in “**FieldFox High Temperature Protection**” on page 28.

Erase User Data

All data that you have written to the FieldFox can be erased with the press of a button. You would do this if your FieldFox is located in a secure environment and must be routinely erased of sensitive data.

All data is removed from the FieldFox internal “UserData” partition. This includes all State files and Trace + State files (*.sta), all Data files (*.csv, *.snp), all Picture files (*.png), all Cal Kit files, and all Cable files.

External media that is inserted (mini-SD card or USB flash drive) is NOT erased.

The “Lost Clusters” folder and files are NOT erased because they are part of the file system housekeeping.

How to Erase User Data

- Press **System 7**.
- Then **Service Diagnostics**.
- Then **Advanced**.
- Then **Erase User Data**.
- Then **Confirm Erase**.
- Then the following occurs:
 - All data files and folders are deleted from the “UserData” partition.
 - The FieldFox is rebooted, which manages the newly-freed data and re-writes the factory cal kits and cable files.

NOTE

Rebooting is not required on the N995xA, N996xA, and applies to: N991xA/2xA/3xA units with serial number prefixes ≥ 5607 .

26 Using the Mini-USB Port to send SCPI Commands and Queries (N995xA/6xA and applies to: N991xA/2xA/3xA units with serial number prefixes ≥ 5607)

NOTE

IMPORTANT! It is recommended that only USB certified cables are used with the FieldFox.

In this Chapter

[“Mini-USB Connection to PC with IO Libraries” on page 495](#)

Mini-USB Connection to PC with IO Libraries

The FieldFox comes with a mini-USB port that can be used to connect to your PC's standard USB 2.0 port. Using Keysight IO Libraries, Connection Expert and connecting via a VISA connection, you can send SCPI commands via the **Keysight Interactive IO** window to the FieldFox. Refer to your IO Libraries online help for the details on connecting to your instrument. Refer to keysight.com to download the IO Libraries.

NOTE

The FieldFox may be communicated with via the VISA libraries. This makes it available to VEE, LabView, and other software tools that can communicate with VISA instruments.

You can connect to USB ports that are not type 2.0 USB. But, the mini-USB port is optimized for a type 2.0 USB ports.

Overview of mini-USB to PC setup for sending SCPI commands and queries:

- Connect a mini-USB (FieldFox device-side) to standard USB (host-PC)
- **On the FieldFox:** Power on the instrument.
- Click **System 7** > **System Diagnostics** > **System Information** and find the FieldFox serial number.
- **On your PC:** Open the **Keysight IO Libraries** software, **Connection Expert** and connect to the FieldFox using the VISA connection. Refer to the Keysight Connection Expert Help.

Using the Mini-USB Port to send SCPI Commands and Queries (N995xA/6xA and applies to: N991xA/2xA/3xA units with serial number prefixes ≥ 5607)
Mini-USB Connection to PC with IO Libraries

- In the **Keysight Interactive IO** window: Type in your SCPIs on the Command line and click **Send Command**, **Read Response**, or **Send & Read**. Refer to the Keysight Connection Expert Help and [Figure 26-1 on page 496](#).

Figure 26-1 Keysight Interactive IO Window

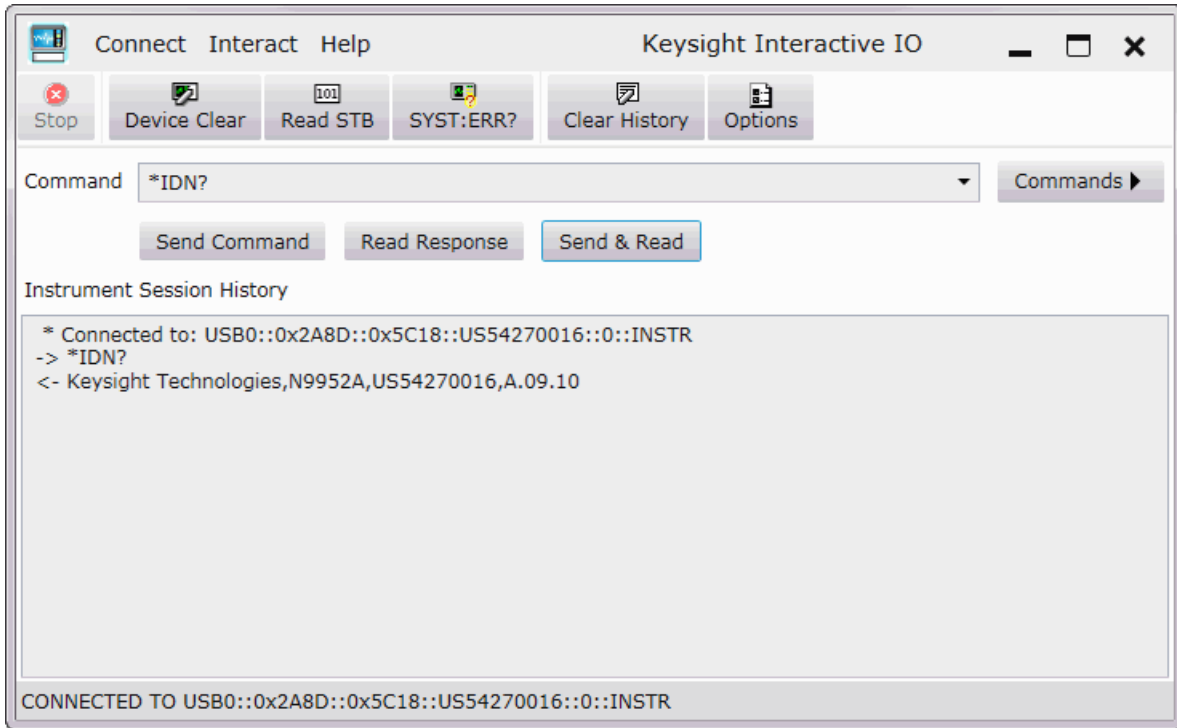

27 File Management

The FieldFox can save any of the following types of files:

- Current settings and calibration
- Trace data (*.csv, *.S1P, *.S2P)
- Picture of the FieldFox screen

In addition, files can be saved to the internal memory, a USB Flash drive, or a standard SD card.

In this Chapter

“Save Files” on page 498

“Recall Files” on page 502

“Move (Copy) Files” on page 502

“Set File Type and Select Device” on page 503

“Manage Files” on page 506

“Manage Folders” on page 508

“Edit Keywords” on page 509

“Prefixes and Suffixes for Filenames” on page 509

See Also:

“Erase User Data” on page 493

Saving and Recalling Files

NOTE

FieldFox State files are intended to be recalled on the same instrument model on which they were saved. Sometimes you may be able to recall them within model families. An error will result when trying to recall a state file that was saved on a different model family.

The FieldFox model families are:

- N991x (VNA/SA) model family
- N992x (VNA) model family
- N993x (SA) model family
- N995x (VNA/SA) model family
- N996x (SA) model family

Save Files

How to Save a File

- Press **Save/Recall 9**
- Then **Save**
- At the top of the current 'labeler' screen (see following image) check the **File Type** to save and **Device** (Internal, USB, Storage Card) to which the file is saved. Learn how to change these settings in **“Set File Type and Select Device” on page 503**.
- Then use the labeler to specify a filename.

CAUTION

If you are having difficulty saving to a USB flash drive, it may be a timing issue. The turn-around time for “file open, write data, file close” to a USB drive is much longer than to FieldFox’s internal memory. Alternative methods are:

1. Save your content to the FieldFox’s internal memory; and then move your files off to a USB flash drive using FTP SCPI programming. Refer to **Using FTP with FieldFox** and to the **FieldFox Programming Guide**.
 2. Save your data to the FieldFox’s internal memory, then move the data to a PC using a binary block transfer, and delete the data from the FieldFox’s internal memory. An example for transferring an image: http://na.support.keysight.com/fieldfox/help/Programming/webhelp/Examples/Transfer_Image_to_PC.htm. Please note that the receiving computer program needs to be able to handle the binary block transfer. See also **FieldFox Programming Guide**.
-

NOTE

Insert only ONE USB flash drive in the FieldFox when saving or copying files.

Saving MATLAB files

NOTE

If you have Option 351 I/Q Analyzer option, you can directly save your data as MATLAB files (*.mat). Refer to [Chapter 11, “IQ Analyzer \(IQA\) – Option 351 \(CPU2 Only\)”](#), on page 235 and to [Chapter 27, “File Management”](#), on page 497.

If you have the FieldFox’s Remote Server mode (89600 VSA software connectivity), you can use the VSA software to capture and record your data as MATLAB files (*.mat). Learn more about FieldFox and 89600 VSA software, refer to [Chapter 12, “Remote Server Mode \(Requires CPU2 and SA Hardware/SA Option 233\)”](#) and to <http://rfmw.em.keysight.com/wireless/helpfiles/89600B/WebHelp/89600.htm>.

Figure 27-1

I/Q Analyzer Mode (IQA) MATLAB File Save

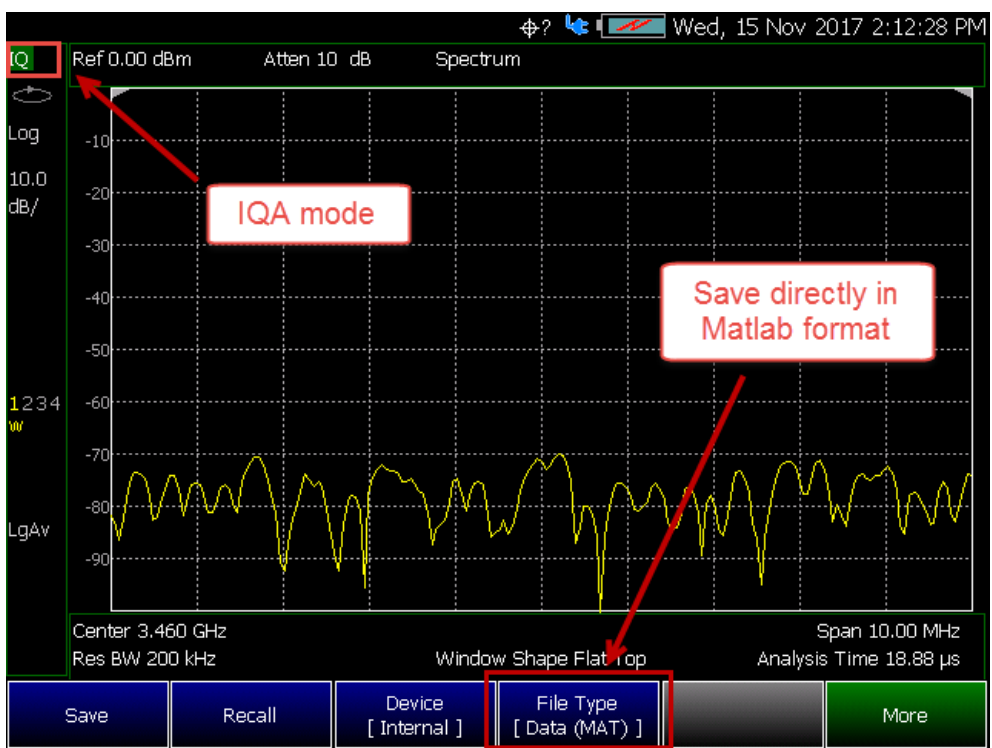
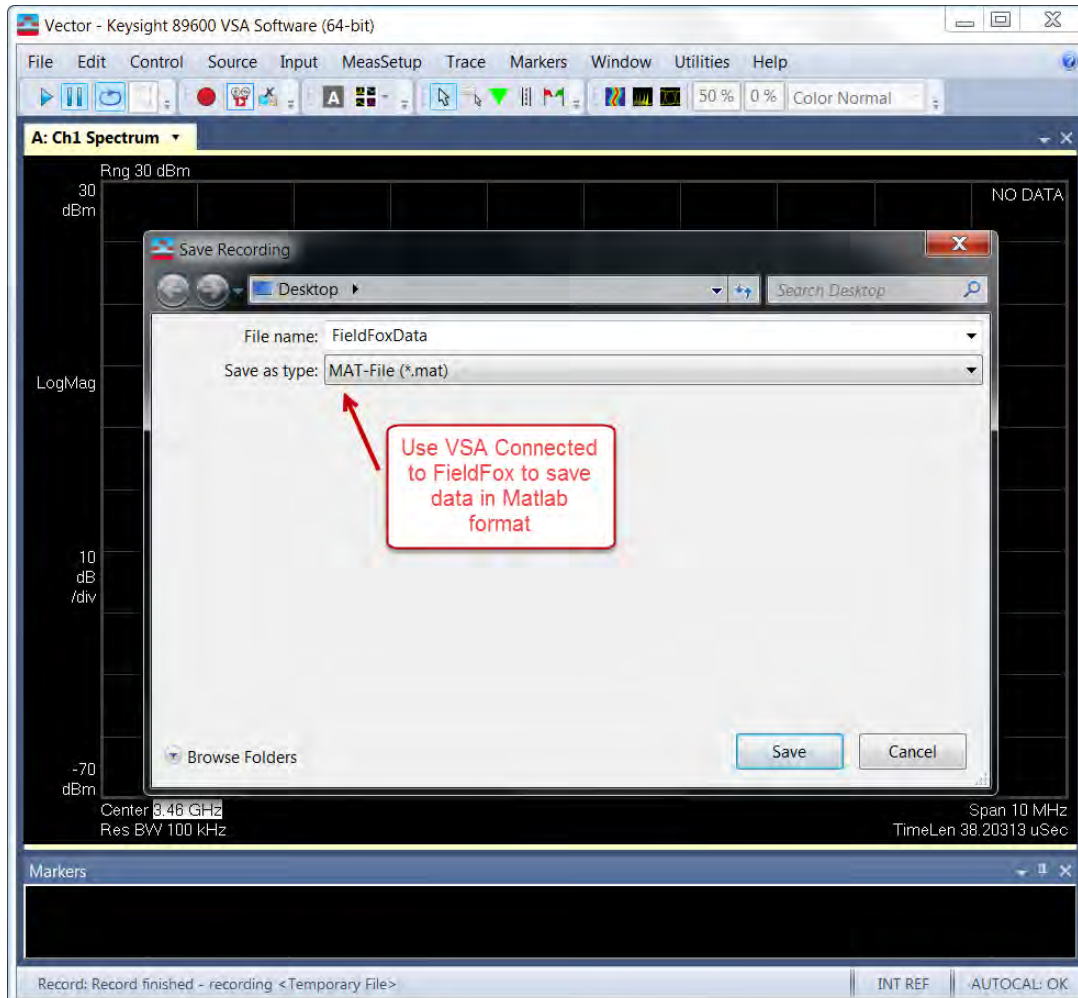

Figure 27-2 VSA Software MATLAB File Save



How to use the FieldFox labeler

The FieldFox labeler is used to edit or change the current filename. It is also used for many other labeling functions, such as creating a title, prefix, and keyword to display on the FieldFox screen. Learn about Titles in **“How to Manage files” on page 506**.

- Move the cursor (see section below, How to move the cursor), then press **Select** to add the cursor character to the end of the existing filename.
- **Back Space** to erase the last character(s) from the end of a filename.
- Press **Shift** to toggle keyboard between lower case and upper case characters.
- Press **Alt Keyboards** to display the different keyword choices.

NOTE

You can select either an ABC or Qwerty style keyboard. Refer to **“Alpha Numeric Editing” on page 477**.

The preselected keywords (File, Site, and so forth) can be selected just like a single character. These keywords can also be edited. Learn more in [“Edit Keywords” on page 509](#).

Figure 27-3 The FieldFox labeler

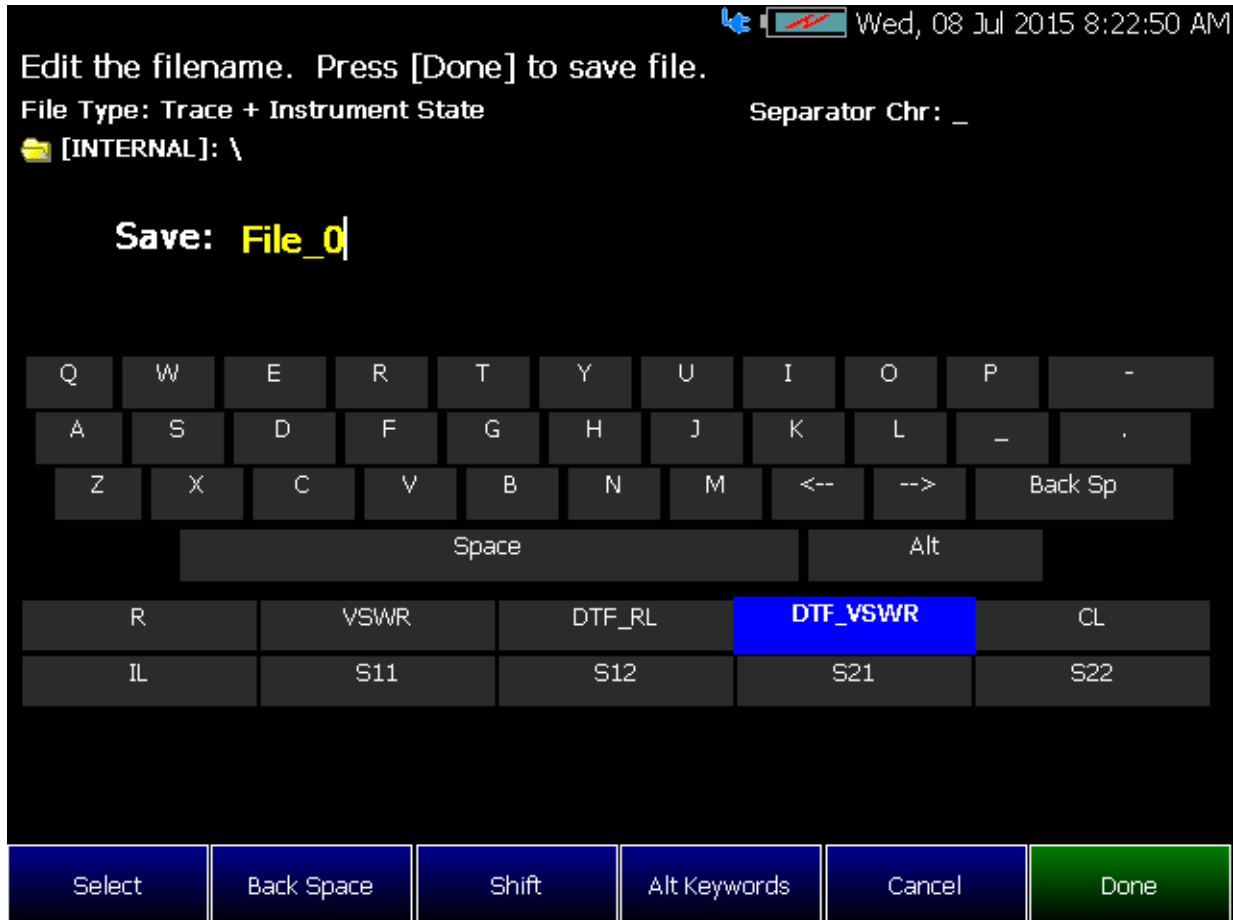

In the graphic above, the current filename is **File_0**. The cursor is on the custom **DTF_VSWR** keyword. The file will be saved to USB (flash drive). File Type is “Trace + State” (Instrument State).

How to move the cursor

- Use the rotary knob to move cursor on the same row. The cursor will change rows when it comes to a row end.
- Use the  arrows to move the cursor up and down the rows.

When the current filename is complete

- Press **Done** to save the file to the specified filename.
- Press **Cancel** to close the labeler without saving a file.

- If the filename already exists, you are prompted to choose from the following:
 - Press **Yes** to overwrite the existing file.
 - Press **Cancel** to return to edit the filename.

Recall Files

The FieldFox can recall **State** files, **Trace + State** files, and image files.

State Files

ALL FieldFox instrument settings for ALL Modes are saved and recalled in a *.sta file. If error correction is ON in CAT or NA Mode, then calibration data is also saved and recalled.

If error correction is OFF (CalRdy is active), calibration data is NOT saved in the *.sta file. When a Trace + State file is recalled on a FieldFox other than the one it was saved on, differences in the CalRdy calibration data may result in differences between the displayed traces.

Image Files

The FieldFox can open and display *.png, *.jpg, and *.jpeg images.

How to Recall a File

NOTE

Before recalling a file, first Select the Device and Location from which the file will be recalled. See the following section for more information.

- Press **Save/Recall 9**
- Then **Recall File** or **Enter**
- Navigate to the file to be recalled using the Up/Down arrow keys.
- Optional: **Sort by Name** to list the current files by name.
- Optional: **Sort by Date** to list the current files by date.
- Optional: **Next Page** if available, to go to the next page of filenames.
- Optional: **Previous Page** if available, to go to the previous page of filenames.
- Then **Recall File** or **Enter**.
- **Cancel** to cancel recall file and return to the previous menu.

Move (Copy) Files

The FieldFox can **Move** files (i.e., including **Trace + State** files, and image files).

How to move a file

- Press **Save/Recall 9**
- Then **Device** to be copied from (i.e., Internal, SD, or USB). Refer to **“Set File Type and Select Device” on page 503**.
- Then **More**
- Then **Manage Files**
- Then **Select Files**
- Navigate to the file(s) to be copied using the Up/Down arrow keys or the knob.
- Then **Copy**
 - Select the destination device using the softkeys:
 - **Copy to Internal** Copies to FieldFox’s internal memory.
 - **Copy to USB** Copies to a USB memory device.
 - **Copy to SD Card** Copies to a SD/SDHC memory card.
 - **Cancel** to cancel copy file and return to the previous menu
 - Use the close folder icon or the open folder icon to locate the target folder for your files.
 - Then **Do Copy** copies files to selected location and FieldFox displays a confirmation message of a successful file copy.
 - **Cancel** to cancel copy file and return to the previous menu.

Set File Type and Select Device

The following File TYPE and DEVICE settings are used to determine the type of file to save, and the location to be used for all file operations.

These two settings remain through an instrument preset, but are reset to the default values when the FieldFox power is shutdown.

Select Device (location of File Save/Recall)

- Press **Save/Recall 9**
- Then **Device** to set the LOCATION where the file is to be saved, recalled, or moved. Choose from the following:
 - **Internal** Saves/Recalls/Moves (Copies) files to/from the FieldFox internal memory. To specify a folder, first select Manage Folders (learn how in **“Manage Folders” on page 508**). The Data Link software will read data ONLY from the \UserData folder.

- **SD Card** Saves/Recalls/Moves (Copies) files to/from the SD card (not included), inserted in the card slot. See **“Take the FieldFox Tour” on page 33**. Only the root folder is available.
- **USB** Saves/Recalls/Moves (Copies) files to or from a USB Flash drive (not included) that is inserted in one of the USB connectors. Only the root folder is available.

NOTE

Insert only ONE USB Flash Drive in the FieldFox when saving or copying files.

How to set File Type

- Press **Save/Recall 9**
- Then **File Type**. Choose one of the following:
 - **State** Saves ALL FieldFox instrument settings for ALL Modes to a *.sta file. If a calibration is ON in CAT or NA Mode, calibration data is also saved. This file can be opened ONLY by a FieldFox. State files can be saved between compatible FieldFox models. See note in: **“Saving and Recalling Files” on page 498**.
 - **Trace+State** Saves the current trace and instrument settings to a *.sta file. In SA Mode, all traces are saved. This file can be opened ONLY by a FieldFox. When recalled, the FieldFox sweep is set to Hold.

CAUTION

When using RTSA, the Density Spectrum information is not saved using Trace+State. Only the last displayed trace settings is saved.

- **Picture (PNG)** Saves a 640 x 453 pixel image of the FieldFox screen to a *.png file. The picture does NOT include the softkeys.
- **Data (csv)** Saves trace data from the current Mode to a *.csv file. This format can be imported into spreadsheet software such as Microsoft Excel. Column A is always the frequency at which the data is measured.
 - In **SA Mode**, all visible data traces are saved. Each trace is saved to a separate column that is labeled with the Trace State.
 - In **CAT** and **NA** Modes, only the data trace is saved – not the memory trace.
 - In **Power Meter** (with Option 208 Frequency Offset Power Sensor (FOPS)), all visible traces are saved. Each trace is saved to a separate column labeled **Output Power** or **Memory**.
 - In **VVM** Mode, NO data is saved.

- **Data (S1P) / (S2P)** Saves **CAT** and **NA** Mode trace data to an *.S1P or *.S2P file, depending on the active measurement. This file format is used by CAE programs such as Keysight's Microwave Design System (MDS) and Advanced Design System (ADS). It can also be imported into spreadsheet software such as Microsoft Excel.

About SNP Files

The SNP file includes header information, and the following data:

- S1P - saves 1-port (receiver) data for the active data trace. *.s1p Files contain 1 stimulus value and 1 S-parameter (total of 3 scalar values) **Stim Real(Sxx) Imag(Sxx)**
- S2P (NA Mode ONLY) - saves 2-port data for the active trace. *.s2p Files contain 1 stimulus value and 4 S-parameters (total of 9 scalar values) **Stim Real(S11) Imag(S11) Real(S21) Imag(S21) Real(S12) Imag(S12) Real(S22) Imag(S22)**
- Only data traces are saved – not memory traces.

Corrections

- When parameters are corrected, data is returned even when not displayed. Data is returned with the correction type that is applied for each S-parameter. The correction type for each S-parameter is annotated in the header.
- When parameters are NOT corrected or displayed:
 - With Smith chart and Polar formats, Real/Imag zero-filled data appears as (1.0, 0.0).
 - With all other formats, LogMag/Phase zero-filled data appears as (0.0, 0.0).

> Display formats

In CAT Mode, S1P files are always Magnitude (dB) / Phase (angle) format.

In NA Mode:

- Smith chart and Polar display formats are ALWAYS saved in Real/Imag data pairs.
- All other display formats are saved in LogMag/Phase (dbAngle).

> What Data Processing functions are included in saved SNP Data:

In NA Mode, the data processing functions (such as trace math) that are included in the SNP data depends on a Preference setting. Click **System**, then **Preferences**, then **Preferences**, then scroll to **NA, SNP File Save**, then select from the following:

- **Default** – SNP data does NOT include smoothing. SNP data saves are taken AFTER data processing (location 2) on the processing chain.
- **Advanced** – SNP data includes the following:
 - With Smith or Polar display format, SNP data saves are taken BEFORE most processing (location 1 on the data processing chain).
 - With any other display format, SNP data saves are taken just AFTER Formatting and Smoothing is applied (location 3 on the data processing chain). For each non-active trace, SNP trace data is reprocessed using the data processing chain of the active trace.

See the FieldFox data processing chain at the **Supplemental Online Help:** <http://na.support.keysight.com/fieldfox/help/SupHelp/FieldFox.htm> Learn more about System Preferences in “**Preferences**” on page 469.

Manage Files

Files that are stored in the FieldFox internal memory, standard SD card, and USB Flash drive, can be copied to another device or deleted.

How to Manage files

- Press **Save/Recall 9**
- Then **Device** to select the location (Internal, USB, or standard SD Card) of the file to copy or delete.

NOTE

When selecting Internal, it may also be necessary to first select Manage Folders to specify an active folder which contains the files to copy or delete. Refer to “**Manage Folders**” on page 508.

-
- Then **More**
 - Then **Manage Files**
 - Then choose from the following:
 - **Select Files** Selects a file or files to sort, copy, or delete.
 - **Sort**
 - **Sort by Name** Sorts the displayed list of files by name.
 - **Sort by Date** Sorts the displayed list of files by date.
 - **Copy** Select a file or files to copy.
 - Then select a device to copy the file to. Choose from **Copy to Internal**, **Copy to USB** (must be inserted), or **Copy to SD Card** (must be inserted).

- **Do Copy** to complete the file copy to the media/folder selected.

NOTE

Copy can be done to any FieldFox internal folder, standard SD folder, or USB storage device.

- **Delete**
 - **Yes** The selected file is deleted.
 - **Cancel** To cancel Delete and return to previous menu.
- **More**
 - **Select Files** Selects a file or files to sort, copy, or delete.
 - **Select All** selects all of the displayed files. All files that are displayed are to be copied. Then select a device and a folder to copy the file to. Choose from Internal, USB (must be inserted), or SD Card (must be inserted).
 - **Clear All** Deselects all of the displayed files.
 - **Rename Files**

NOTE

For more on renaming folders/files, refer to **“How to use the FieldFox labeler ” on page 500** and **“Prefixes and Suffixes for Filenames” on page 509**.

- Enter the string in the filename or filenames that are to be replaced.

NOTE

String to Replace is case sensitive.

- **Replace With** Enter the string that is to be replaced by the characters entered with the String to Replace softkey.
- **Prefix** Enter a prefix (one time) that the current filename or filenames are to be renamed. To add a prefix to subsequent filenames (persistent), refer to How to edit the Prefix and Suffix (Auto Append) in **“How to edit the Prefix and Suffix (Auto Append)” on page 510**.
- **Suffix** Enter a suffix that the current filename or filenames are to be renamed.
- **Do Rename** Enable renaming of the current file or files.

NOTE

Insert only ONE USB Flash Drive in the FieldFox when saving or copying files.

Manage Folders

You can create new folders, delete old folders, and select the active folder to which files can be saved. The Parent folder [...] is listed when not in the root directory.

Press Save/Recall 9

- Press **Save/Recall 9**
- Then **More**
- Then **Manage Folders**
- Then choose from the following:
 - **Change Folder** Changes the active folder to which files can be saved. The active device and current folder is displayed at the top of the screen, and below, a list of files in that folder. Use the **▲▼** arrows to highlight a folder within the current folder. Each time the **Change Folder** softkey is pressed, the highlighted folder becomes the active folder.
 - **Create Folder** A new folder is created in the current folder. Select a name for the new folder from one of the displayed keywords: You can change these keywords using the following **Edit Keywords** function. Refer to Edit Keywords in **“Edit Keywords” on page 509**.
 - **Delete Folder** The **selected** folder and its contents are deleted after a warning prompt is displayed. A “Parent” folder or system folder can NOT be deleted.
 - **Copy Folder** The **selected** folder and its contents are copied and a message is displayed telling you that the copy was successful.
 - Then select a device to copy the folder to. Choose from **Copy to Internal**, **Copy to USB** (must be inserted), or **Copy to SD Card** (must be inserted).
 - Do Copy** to complete the file copy to the media/folder selected.
 - **Rename** The rename folder menu opens and the selected folder’s title is displayed and available for editing.

NOTE

For more on renaming folders/files, refer to **“How to use the FieldFox labeler ” on page 500**, and **“Prefixes and Suffixes for Filenames” on page 509**.

-
- Press **Exit** when finished.

Edit Keywords

The preselected keywords (FILE, SITE, and so forth) can be edited to meet your specific needs. Your keywords will remain in the FieldFox until you change them. Keywords are limited to 30 characters.

How to edit keywords

- Press **Save/Recall 9**
- Then **More**
- Then **Edit Keywords**
- Then **Next Page** and **Previous Page** to view all keywords.
- Use the **▲▼** arrows to select a keyword to edit.
- When a keyword is selected, then press **Edit**.
- Then choose from the following:
 - Press **Select** to add the cursor character to the end of the selected keyword.
 - Press **Backspace** to erase the last character from the end of the selected keyword.
 - Press **Shift** to change from upper-case to lower-case and vice versa.
 - Press **Alt Keywords** to toggle through different keyword choices.

How to move the cursor:

- Use the rotary knob to move the cursor along the same row. The cursor will change rows when it comes to a row end.
- Use the **▲▼** arrows to move the cursor up and down between rows.

When the selected keyword is complete:

- Press **Done** to save all keywords and close the Edit Keywords labeler. These keywords will exist on the FieldFox until changed.
- Press **Cancel** to close the labeler without saving changes.

Prefixes and Suffixes for Filenames

The prefix and suffix (Auto Append) can be used together to organize files. Once set and enabled, they are automatically entered as the beginning (Prefix) and end (Suffix - using Auto Append) of a filename when performing a Save

operation. These settings are persistent, until disabled. Refer to [“How to edit the Prefix and Suffix \(Auto Append\)” on page 510](#) and [“How to enable/disable Auto Append \(Suffix\)” on page 511](#).

NOTE

If you are only interested in adding a prefix or a suffix to a new file or files one time, refer to [“Manage Files” on page 506](#).

This section contains the following sections:

- [“How to edit the Prefix and Suffix \(Auto Append\)” on page 510](#).
- [“How to move the cursor” on page 501](#).
- [“When the Prefix is complete” on page 511](#).
- [“How to enable/disable Auto Append \(Suffix\)” on page 511](#).

How to edit the Prefix and Suffix (Auto Append)

If you want to edit a prefix on a finite set of files one time, refer to [“Manage Files” on page 506](#).

- Press **Save/Recall 9**
- Then **More**
- Then **Prefix Suffix**
- Then choose from the following:
 - **Edit Prefix** to edit the prefix using the labeler. For more, refer to [“How to edit the Prefix and Suffix \(Auto Append\)” on page 510](#).
 - **Select** to add the cursor character to the end of the Prefix.
 - **Back Space** to delete the last character(s) from the end of the prefix.
 - **Shift** to toggle between capital letters and lower case letters.
 - **Alt Keywords** to display the different preselected keywords (File, Site, and so forth) can be selected just like a single character. These keywords can also be edited. See Edit Keywords.
 - **Cancel** to cancel edits and return to the previous menu.
- **Auto Append** (Suffix)
 - **OFF** to turn off Auto Append.
 - **Number** to auto-append a number using format “_nnn” sequentially to all saved files.
 - **Date** to auto-append a date and time using format “_YYYY-MM-DD.HH.MM.SS” sequentially to all saved files.

- **Number Suffix Reset** to reset Auto Append number to “_001”.
- **Prefix**
 - **OFF** to disable the prefix. The Prefix softkeys are grayed out (inactive). Refer to How to enable/disable the Prefix (persistent) in **“How to enable/disable the Prefix (persistent)” on page 511.**
 - **Last File** to use the last filename saved, as your filename for subsequent saved filenames.
 - **User** to use the user-selected prefix.
- **Back** to return to the previous menu.

NOTE

When Last File is selected, the Edit Prefix and Auto Append softkeys are unavailable (grayed out). Refer to **“Prefixes and Suffixes for Filenames” on page 509.**

How to move the cursor

- Use the rotary knob to move cursor on the same row.
- Use the  arrows to move the cursor up and down the rows.

When the Prefix is complete

- Press **Done** to save the Prefix and close the labeler. This Prefix will exist on the FieldFox until it is changed.
- Press **Cancel** to close the labeler without saving changes.

How to enable/disable the Prefix (persistent)

- Press **Save/Recall 9**
- Then **More**
- Then **Prefix Suffix**
- Then **Prefix**
 - **OFF** to disable the prefix on subsequently saved files. Edit Prefix, Auto Append, and Number Suffix Reset softkeys are grayed out (inactive).

How to enable/disable Auto Append (Suffix)

- Press **Save/Recall 9**
- Then **More**
- Then **Prefix Suffix**
- Then **Auto Append**
- **OFF** to disable the Auto Append (Suffix) on subsequently saved files. Auto, and Number Suffix Reset softkeys are grayed out (inactive).

Press Printing

The current screen or selected files can be printed using a PCL-compatible printer (like older HP Deskjet printer) connected to one of the FieldFox USB ports. Newer PCL3GUI photo and all-in-one printers are NOT supported.

Measurements can also be printed using the FieldFox Data Link software.

How to print the current screen or a saved file

To save ink, first select an outdoor (white background) display color. Learn how in **“Display Colors” on page 467**.

- Connect the printer to a FieldFox USB port. **The print softkey will appear ONLY when a compatible printer is connected.**
- Then press **Save/Recall 9**
- Then **Print** and choose from the following:
 - **Printer & Page\nSetup** – Confirm that the printer is connected and configured properly. The Status line should read “Ready”.
 - Make other print settings as desired.
 - **Select Files\nfor Printing** – Print up to 16 *.PNG images on one page that are stored on the Internal drive. Images can NOT be printed from the USB and SD card.
 - Edit the Quick Settings table to select up to FOUR Rows and FOUR Columns for up to 16 total images to be printed on a single page.
 - If necessary, edit the filenames to be printed.
 - Select **Done**. Then **Print Selected\nFiles** to begin printing.
 - **Print Current Screen** – Immediately prints the FieldFox screen using the selected Printer and Page Setup settings.

28 Working with the Lithium-Ion Battery

In this Chapter

[“Viewing the Battery Charge Status” on page 513](#)

[“Charging the Battery” on page 515](#)

[“Reconditioning Battery” on page 518](#)

[“Battery Care” on page 518](#)

[“Maximizing Battery Life” on page 518](#)

[“Lithium-Ion Battery Disposal” on page 519](#)

See Also:

[“Install the Lithium-Ion Battery” on page 26](#)

[“To conserve battery power:” on page 27](#)

[“For the Battery” on page 525](#)

Viewing the Battery Charge Status

You can view the battery charge status in the following ways:

- Icons in the upper right of the front panel screen.
- Battery screen - select System then Service Diagnostics then Battery.
- Built-in battery gauge. Learn more in the following section.

Table 28-1

Front Panel Icons



Icon	Status
	Connected to external power through the AC/DC adapter. Battery installed and charging. The amount of charge is indicated by the number of bars shown.

Table 28-1

Front Panel Icons

Icon	Status
	Battery not charging with 84% battery life remaining.
	Battery fully charged. A fully charged battery MAY NOT read 100%.

Service Diagnostics—Battery Screen

The Battery screen displays the following information. To access the screen, select System then Service Diagnostics then Battery.

Additional battery information is available using SCPI commands.

1. **Status** – Fully charged, No battery, Charging, Empty, or Discharging.
2. **External DC Supply** – ON or OFF indicates if an external DC supply is connected.
3. **Battery Present** – ON or OFF indicates if a battery is installed.

NOTE

Items 4 through 8 are read directly from the battery. The information is based on the battery's internal sensors and memory.

1. **Voltage** – measured by the battery's sensor.
2. **Current** – amount of current being consumed when operating from internal battery. If battery is charging, indicates amount of charging current.
3. **Battery Temperature** – internal temperature of the battery as measured by a sensor embedded in the battery.
4. **Present Run Time to Empty** – minutes of power remaining based on amount of current being used now.
5. **Charge Cycles** – number of charge cycles the battery has experienced. Charge cycle defined as $\geq 80\%$ change in relative state of charge.

Built-In Battery Gauge

Each lithium ion battery has an LED gauge that displays its charge status. The gauge is active unless the battery is in shut down mode.

To view the LED gauge, open the FieldFox battery compartment door, remove the battery, then press the button on the battery.

The battery in your FieldFox will have either 4 or 5 LED segments.

5-segment Gauge	Charge Remaining	4-segment Gauge	Charge Remaining
5 segments	≥80%	4 segments	≥75%
4 segments	60% to 79%	3 segments	50%,to 74%
3 segments	40% to 59%	2 segments	25% to 49%
2 segments	20% to 39%	1 segment	< 25%
1 segment	< 20%		

Charging the Battery

When you receive your FieldFox, the lithium-ion battery is partially charged to approximately 30% to 40% to preserve battery life. Allow four hours to fully charge the battery internally, or three and a half hours () by using the external battery charger (N9910X-872). A fully charged battery will power your FieldFox for about four hours. Upon receiving your FieldFox, it is NOT necessary to charge your FieldFox's battery before using your instrument.

The FieldFox circuitry ALWAYS prevents the battery from discharging to a level that is damaging. However, if the battery is completely discharged, the FieldFox may not turn ON. If this occurs, the battery can still be charged either internally or externally.

Because a lithium-ion battery has no memory effect, you can charge a battery at any time regardless of the current charge status.

Internal Charging with the AC/DC Adapter

NOTE

Read the safety information in **“For the AC/DC Adapter” on page 524.**

Internal charging time for a fully depleted battery is approximately 4 hours with the FieldFox either ON or OFF.

Figure 28-1 AC/DC Adapter



To charge a battery inside the FieldFox, insert the AC/DC adapter plug into the Power connector on the FieldFox side panel, then plug the adapter into an AC outlet.

- FieldFox ON: Charging is indicated by a battery icon in the upper right of the front panel screen.
- FieldFox OFF: Charging is indicated by the FieldFox power LED glowing amber, with its intensity increasing from dim to bright every few seconds. This pattern repeats until the LED turns off when charging is done. Learn more on **“Front Panel” on page 33.**

Using the External Battery Charger (N9910X-872)

NOTE

Read the safety information in **“For the External Battery Charger (N9910X-872)”** on page 525.

Figure 28-2 External Battery Charger (N9910X-872)



The external battery charger (N9910X-872), lets you charge a fully depleted battery in approximately three hours. It is a two bay, level-3 stand-alone battery charger that is compliant with the standard Smart Battery System. The two bays are charged sequentially on a first-come, first-served basis, though a discharge can be performed in the left bay while the right bay is charging.

External Battery Charger LED	Charging Status
Green	Fully charged
Green flashing	Fast charging
Yellow flashing	Reconditioning – the accuracy of the battery’s internal LED charge gauge is being renewed. See “Reconditioning Battery” on page 518
Yellow/green	Battery is reconditioned
Red flashing	Error
Yellow	Standby

For more information, refer to the Instruction Manual included with the external battery charger.

Reconditioning Battery

Reconditioning a battery can be performed ONLY with the External Battery Charger (N9910X-872).

1. Insert a battery into the left bay of the external charger.
2. Press the button labeled Push to Recalibrate Left Battery Bay
3. The charger will charge the battery fully, discharge it completely, then recharge it fully again. The entire process can take up to 12 hours.
4. Install the battery into the FieldFox.
5. On the System, Battery screen, verify that the battery is fully charged.

Battery Care

Visually inspect the battery periodically for signs of degradation, such as swelling, cracking of the battery shell, or leakage of fluid. If degradation occurs, replace the battery and dispose of it properly. Refer to **“Lithium-Ion Battery Disposal” on page 519**. Operation with a degraded battery could result in damage to the FieldFox.

Maximizing Battery Life

- If AC power is not continuously available (Ex: in a field environment), use the battery and recharge it when it holds a 20% to 50% charge, as shown on the screen’s battery charge icon. At this charge level, 2 or 3 segments show on the battery gauge.
- If the FieldFox is not going to be used for more than a week, remove the battery. Best practice is to store the battery with a charge of about 50%. At this charge level, 3 segments show on the battery gauge.
- Allow a battery to warm to room temperature before charging it. Temperature shock can damage the battery chemistry and in some cases cause a short circuit.
- Store batteries in a cool, dry location, away from metal objects and corrosive gases.
Storage temperature limits (20% to 50% relative charge is recommended):
 - Transportation: –20°C to 50°C
 - Within 1 month: –20°C to 45°C
 - Within 6 months: –20°C to 40°C
 - Within 1 year: –20°C to 35°C

- Battery charging limits:
Charge temperature: 0°C to 45°C (<10°C slows charge on some batteries)
Discharge temperature: –10°C to 60°C
- Operate the FieldFox on battery power between the ambient temperatures of –10 and +50°C (–14 to +122°F). Using the battery at lower or higher temperatures can damage it and reduce operating life. Cold temperatures affect battery chemistry, reducing charge capacity, especially below 0°C (32°F).

Lithium-Ion Battery Disposal

When you notice a large decrease in charge capacity after proper recharging, it's probably time to replace the battery.

Lithium-Ion batteries need to be disposed of properly. Contact your local waste management facility for information regarding environmentally sound collection, recycling, and disposal of the batteries. Regulations vary for different countries. Dispose of the battery in accordance with local regulations.

Keysight Technologies, through Rechargeable Battery Recycling Corporation (RBRC), offers free and convenient battery recycling options in the U.S. and Canada. Contact RBRC at 877-2-RECYCLE (877.273.2925) or online at: <http://www.call2recycle.org/> for the nearest recycling location.

Working with the Lithium-Ion Battery
Lithium-Ion Battery Disposal

29 Safety Considerations

Keysight has designed and tested the FieldFox in accordance with IEC Publication 61010-1 Safety Requirements for Electrical Equipment for Measurement, Control and Laboratory Use, and the FieldFox is supplied in a safe condition. The FieldFox is also designed for use in Installation Category II and pollution Degree 2 per IEC 61010-1. Read the following safety notices carefully before you start to use this FieldFox to ensure safe operation and to maintain the product in a safe condition.

For the FieldFox

WARNING

No operator serviceable parts inside except for the lithium-ion battery. Refer servicing to qualified personnel. To prevent electrical shock do not remove covers.

WARNING

If this product is not used as specified, the protection provided by the equipment could be impaired. This product must be used in a normal condition (in which all means for protection are intact) when attached to the AC-DC adapter.

WARNING

The unit may be used only in the operating conditions and positions specified by the manufacturer.

WARNING

Do not install substitute parts or perform any unauthorized modification to the product. Return the product to Keysight Technologies or a designated repair center for service to ensure that safety features are maintained.

WARNING

Applicable local or national safety regulations and rules for the prevention of accidents must be observed in all work performed.

WARNING

Ensure that the connections with information technology equipment comply with IEC950 / EN60950.

WARNING

Observe all ratings and markings of the instrument before connecting the instrument.

Maximum Input Voltages and Power:

RF Output Connector: 50V DC, +23 dBm RF

Ext Trig/Ref Connector: 5.5 V DC

RF Input: ± 50 VDC, +27 dBm RF

DC Input: 19VDC, 4ADC

WARNING

When performing a measurement, ensure that the right safety and performance ratings of the instrument and accessories are used.

Do not expose the circuit or operate the instrument without its cover or while power is being supplied.

Do not operate the instrument in any environment at risk of explosion.

CAUTION

The power cord and connectors shall be compatible with the connector used in the premise electrical system. Failure to ensure adequate earth grounding by not using the correct components may cause product damage and serious injury.

CAUTION

The measuring terminals on this instrument are designed to be used with external signals described in Measurement Category I, but NOT with external signals described in Categories.

For the AC/DC Adapter

WARNING

Use only the designated AC/DC adapter supplied with the instrument.

WARNING

Use only the designated power cord supplied with the AC/DC adapter.

WARNING

Operated at an ambient temperature: 0 to 40°C; full power rating; derate linearly to 50 W at 50°C.

Maximum output rating: +15V/4.0 A.

Input rating: AC 100–250 V, 50/60Hz

WARNING

Main Plug: Use a 3-pin main plug that complies with IEC 60884–1, Plugs and Socket–Outlets for Household and Similar Purposes – Parts 1: General Requirements and country specific safety authority requirements, such as UL, SA, BSI, VDE, CCC, SA, NZ, and PSE.

WARNING

Appliance Connector: Use an appliance connector certified to IEC 60320–1/EN 60320–1 requirements

WARNING

To prevent electrical shock, disconnect the AC to DC adapter from the mains before cleaning. Use a dry cloth or one slightly dampened with water to clean the external case parts. Do not attempt to clean internally.

WARNING

When the FieldFox is connected to the AC/DC adapter, position the adapter so the power cord is readily accessible. The power cord is the disconnecting device. It removes main power to the AC/DC adapter. The FieldFox front panel switch is only for the DC power within the instrument, and not for the AC/DC adapter. Alternately, an AC switch or circuit breaker (which is readily identifiable and is easily reached by the operator) may be installed and used as a disconnecting device to remove mains power from the AC/DC adapter.

WARNING

To avoid overheating, always disconnect the FieldFox from the AC/DC adapter before storing the FieldFox in the backpack.

If you prefer to leave the FieldFox connected to the AC/DC adapter while inside the backpack, you can disconnect the AC/DC adapter from its AC power source to prevent overheating.

CAUTION

The AC/DC adapter has an auto-ranging line voltage input – be sure the supply voltage is within the specified range.

CAUTION

The AC/DC adapter is for indoor use only.

CAUTION

Never use a modified or damaged charger. Use the original AC-DC adapter ONLY.

CAUTION

The AC/DC adapter is designed for use in Installation Category II and Pollution Degree 2 per IEC 61010-1.

For the External Battery Charger (N9910X-872)

CAUTION

If charging batteries externally, use the optional external charger available from Keysight, or another SMBus charger of level II or higher.

Never use a non-SMBus charger because the battery issues commands over the SMBus to the charger to control the charge rate and voltage.

Never use a modified or damaged charger.

External AC/DC power supply, U.S. FCC compliance

Meets the required verification equipment authorization rules.

This device complies with part 15 of the FCC Rules. Operation is subject to the following two conditions: (1) This device may not cause harmful interference, and (2) this device must accept any interference received, including interference that may cause undesired operation.

For the Battery

Lithium battery packs may get hot, explode, or ignite and cause serious injury if exposed to abuse conditions. Be sure to follow these safety warnings:

WARNING

Lithium-ion batteries:

- Must not be exposed to high temperatures (>70°C) or fire.
 - Must be kept away from children.
 - Must not be short circuited.
 - Must be replaced only with Keysight qualified Li-ion batteries.
 - If replaced or charged improperly, there is a danger of explosion.
-

WARNING

Do not connect the positive terminal and negative terminal of the battery to each other with any metal object (such as wire).

WARNING

Do not carry or store the battery with necklaces, hairpins, or other metal objects.

WARNING

Do not pierce the battery with nails, strike the battery with a hammer, step on the battery, or otherwise subject it to strong impacts or shocks.

WARNING

Do not solder directly onto the battery.

WARNING

Do not expose the battery to water or salt water, or allow the battery to get wet.

WARNING

Do not disassemble or modify the battery. The battery contains safety and protection devices, which if damaged, may cause the battery to generate heat, explode, or ignite.

WARNING

Do not place the battery in direct sunlight, or use or store the battery inside cars in hot weather. Doing so may cause the battery to generate heat, explode, or ignite. Using the battery in this manner may also result in a loss of performance and a shortened life expectancy.

WARNING

There is a danger of explosion if the battery is incorrectly replaced. Replace only with the same or equivalent type of battery recommended. Discard used batteries according to manufacturer's instructions.

WARNING

If you are charging the batteries internally, even while the FieldFox is powered off, the FieldFox may become warm. Allow for proper ventilation.

WARNING

Do not discharge the battery using any device except the FieldFox or the external battery charger (N9910X-872). When the battery is used in a device other than those specified, it may damage the battery or reduce its life expectancy. If the device causes an abnormal current to flow, it may cause the battery to become hot, explode, or ignite and cause serious injury.

WARNING

For a Korean battery safety consideration translation, refer to [Appendix D: "Korean Battery Safety Translation."](#)

Battery Protective Functions

The following protective functions are designed into the lithium-ion rechargeable battery system used in FieldFox.

The protective functions can be divided between two categories: active and passive. Active protection refers to the type of protection that depends on at least two or more protection devices working together to enable the protection. Passive protection refers to the type of protection that is always enabled independent of any other protection device.

Active Protection

Primary Overcharge Voltage: This prevents the battery from being charged if the voltage across any cell exceeds approximately 4.35 V per cell. Once the overcharge protection is tripped, the voltage across each cell must drop below approximately 4.15 V to reset the protection and permit charging.

Secondary Overcharge Voltage: This is a one-time, permanent protection that is triggered when the voltage across any cell exceeds approximately 4.45 V. Once this protection is tripped, the battery can no longer be used and must be replaced.

Overdischarge Voltage: This prevents the battery from discharging if the voltage across any cell drops below approximately 2.6 V. Once the overdischarge voltage protection is tripped, the voltage across each cell must be charged to approximately 3 V to reset the protection and permit discharging.

Primary Overcharge Current: This prevents the battery from being charged if the average charging current reaches or exceeds 3.5A for a time period of 120 seconds or more.

Secondary Overcharge Current: This prevents the battery from being charged if the charging current reaches or exceeds $4A \pm 20\%$ for a time period of 20 milliseconds or more.

Primary Overdischarge Current: This prevents the battery from being discharged if the average current out of the battery reaches or exceeds 5A for a time period of 120 seconds or more. This protection can be reset by removing the load.

Secondary Overdischarge Current: This prevents the battery from being discharged if the current out of the battery reaches or exceeds 6A for a time period of 20 milliseconds or more. This protection can be reset by removing the load.

Short Circuit Protection: This prevents the battery from being charged or discharged and protects against damage or lost data if the current in or out of the battery reaches or exceeds 12.5A for a time period of 183 microseconds or more. This protection can be reset by removing the load.

Overtemperature Charging: The system microcontroller prevents the battery from being charged if the cell temperature exceeds 46°C. Once the overtemperature charging protection is tripped, the cell temperature has to drop to or below 45°C to reset the protection and permit charging.

Overtemperature Discharging: The system microcontroller prevents the battery from being discharged if the cell temperature exceeds 65C. Once the overtemperature discharging protection is tripped, the battery is automatically shut off which results in turning off the instrument as well.

Passive Protection

Reverse Charging: A reverse protection diode prevents against damage or lost data due to a reverse charge polarity applied to the battery terminals.

Primary Overtemperature: A PTC (positive temperature coefficient) polyfuse in series between the Li-ion cells and the charging and discharging transistors will open up and limit current flow to the battery terminals as a function of very high temperatures. This protection is resettable once the overstress condition is removed.

The maximum operating temperature of this fuse is 85C.

Secondary Overtemperature: A second PTC polyfuse built into each Li-ion cell will open up and limit current flow as a function of very high temperatures.

Tertiary Overtemperature: A current interrupt device (CID) within each Li-ion cell will permanently open up when the temperature reaches 95C. As each cell fuse is permanently interrupted, overall battery performance will become severely degraded, up to and including disabling the battery.

Overcurrent Fuse: This is a one-time blow fuse with a rated current of 12A.

Batteries: Safe Handling and Disposal

To learn how to safely handle and dispose of the FieldFox battery, refer to the Material Safety Data Sheet for the manufacturer of the battery at:

<http://na.support.keysight.com/fieldfox/help/SupHelp/Reference/MSDS.htm>

Environmental Requirements

Refer to the FieldFox Specifications in “[Specifications/Data Sheet](#)” on [page 541](#).

Electrical Requirements

The FieldFox allows you to use either the lithium-ion battery or the AC/DC adapter - both are included.

Electrostatic Discharge (ESD) Precautions

The FieldFox was constructed in an ESD protected environment. This is because most of the semiconductor devices used in this instrument are susceptible to damage by static discharge.

Static charges are generated in numerous ways, such as simple contact, separation of materials, and normal motions of persons working with the FieldFox. To prevent instrument damage, practice industry accepted techniques for handling static sensitive devices when using the FieldFox.

Very often, coaxial cables and antennas also build up a static charge, which, if allowed to discharge by connecting to the FieldFox, may damage the instrument input circuitry. To avoid such damage, it is recommended to dissipate any static charges by temporarily attaching a short to the cable or antenna prior to attaching to the instrument.

FieldFox Markings



The CSA mark is a registered trademark of CSA International.



The C-Tick Mark is a registered trademark of the Australian Spectrum Management Agency.



The RCM Mark is a registered trademark of the Australian Communications and Media Authority.



This symbol combines the following three markings:

CE indicates product compliance with all relevant European legal Directives (if accompanied by a year, it signifies when the design was proven).

ICES indicates product compliance with the Canadian Interference-Causing Equipment Standard (ICES-001).

ISM indicates this is an Industrial Scientific and Medical Group 1 Class B product (CISPR 11, Clause 4)



The Standby symbol is used to mark a position of the instrument power line switch.



This symbol indicates separate collection for electrical and electronic equipment, mandated under EU law as of August 13, 2005. All electric and electronic equipment are required to be separated from normal waste for disposal (Reference WEEE Directive, 2002/96/EC).



Indicates the time period which no hazardous or toxic substance elements are expected to leak or deteriorate during normal use. Forty years is the expected useful life of the product.

This symbol indicates the Environmental Protection Use Period (EPUP) for the product's toxic substances and for the China RoHS requirements.



CAUTION, risk of danger, refer to safety information in manual.



Dispose of properly

Safety Considerations
Battery Markings



Hot surface - connectors get hot during extended operation, so care must be taken when making connections and disconnections.

Battery Markings



The CE mark shows that the product complies with all relevant European legal Directives (if accompanied by a year, it signifies when the design was proven).



The battery parts can be recycled. Consult local or country regulations.



Dispose of properly. Do not throw batteries away—collect as small chemical waste.



Recycle the old battery properly. Consult local or country regulations related to disposal.



Keep battery away from excessive heat. Do not dispose of by burning.



UL recognized in Canada and the United States.



The C-Tick Mark is a registered trademark of the Australian Spectrum Management Agency.



The RCM Mark is a registered trademark of the Australian Communications and Media Authority.



Korean Certification (KC) mark; includes the marking's identifier code which follows the format: KCC-REM-YYY-ZZZZZZZZZZZZZZ or MSIP-REM-YYY-ZZZZZZZZZZZZZZ

Safety Considerations
Battery Markings

BIS (Bureau of Indian Standards) standard mark for registration.



Indicates the time period which no hazardous or toxic substance elements are expected to leak or deteriorate during normal use. Ten years is the expected useful life of the product.



This symbol indicates the Environmental Protection Use Period (EPUP) for the product's toxic substances and for the China RoHS requirements.

Packaging Markings



This symbol on all primary and secondary packaging indicates compliance to China standard GB 18455-2001.

AC/DC Adapter Markings



The UL Marks are registered certification marks of Underwriters Laboratories Inc. (UL). It means that UL has tested and evaluated representative samples of that product and determined that it meets UL's safety requirements. When accompanied by a 'C' and 'US', it indicates compliance to both Canadian and US requirements.



NOM Mark (Normality of Mexico) indicates that the product was tested by an accredited laboratory in Mexico and meets Mexico's safety requirements.



Japan's safety and EMC compliance mark.



China's safety and EMC compliance mark.



Taiwan's safety and EMC compliance mark.



Singapore's safety mark.







Korean Certification (KC) mark; includes the marking's identifier code which follows the format: KCC-REM-YYY-ZZZZZZZZZZZZZZ or MSIP-REM-YYY-ZZZZZZZZZZZZZZ



GOST, Russia's safety and EMC mark.

Safety Considerations
Certification and Compliance Statements

	AC (Alternating Current).
	Direct current (DC) equipment
	CAUTION, risk of danger, refer to safety information in manual.
	DC connector polarity
	Dispose of properly

Certification and Compliance Statements

Certification

Keysight Technologies, Inc. certifies that this product met its published specifications at the time of shipment from the factory. Keysight Technologies, Inc. further certifies that its calibration measurements are traceable to the United States National Institute of Standards and Technology, to the extent allowed by the Institute's calibration facility, and to the calibration facilities of other International Standards Organization members.

Manufacturer's Declaration

This product has been designed and tested in accordance with accepted industry standards, and has been supplied in a safe condition. The documentation contains information and warnings that must be followed by the user to ensure safe operation and to maintain the product in a safe condition.

Declaration of Conformity

Should the Declaration of Conformity be required, visit:

<http://www.keysight.com/go/conformity>.

For more information, see **“Where to Find the Latest Information” on page 3.**

EMC

Complies with the essential requirements of the European EMC Directive as well as current editions of the following standards (dates and editions are cited in the Declaration of Conformity):

- IEC/EN 61326-1
- CISPR Pub 11 Group 1, class B
- AS/NZS CISPR 11
- ICES/NMB-001

This ISM device complies with the Canadian ICES-001.
Cet appareil ISM est conforme a la norme NMB-001 du Canada.

Safety

Complies with the European Low Voltage Directive

- IEC/EN 61010-1
- Canada: CSA C22.2 No. 61010-1
- U.S.A.: UL std no. 61010-1

South Korean Class B EMC Declaration

This equipment is Class B suitable for home electromagnetic environment and is suitable for use in all areas.

B급 기기
(가정용 방송통신기자재)
이 기기는 가정용(B급) 전자파적합기기로서 주로 가정에서 사용하는 것을 목적으로 하며, 모든 지역에서 사용할 수 있습니다.

Acoustic Statement (European Machinery Directive)

Acoustic Noise Emission

LpA <70 dB

Operator position

Normal operation position per ISO 7779

Safety Considerations
Certification and Compliance Statements

A: Connector Care Review

Proper connector care and connection techniques are critical for accurate and repeatable measurements. The following table contains for tips on connector care.

Prior to making connections to your analyzer, carefully review the information about inspecting, cleaning, and gauging connectors. For course numbers about additional connector care instruction, contact Keysight Technologies.

Handling and Storage

Do

- Keep connections clean
- Extend sleeve or connector nut
- Use plastic end-caps during storage

Do Not

- Touch mating-plane surfaces
- Set connectors contact-end down
- Store connectors or adapters loose

Visual Inspection

Do

- Inspect all connectors carefully
- Look for metal particles, scratches, and dents

Do Not

- Use a damaged connector—ever

Connector Cleaning

Do

- Try compressed air first
- use isopropyl alcohol^a
- Clean connector threads

Do Not

- Use any abrasives
- Get liquid into plastic support beads

Gaging Connectors

Do

- Clean and zero the gage before use
- Use the correct gage type
- Use correct end of calibration block
- Gage all connectors before first use

Do Not

- Use an out-of-specification connector

Gaging Connectors

Do

- connectors carefully
- Make preliminary connection contact lightly
- Turn only the connector nut
- Use a torque wrench for final connection

Do Not

- Apply bending force to connection
- Over Tighten preliminary connection
- Twist or screw any connection
- tighten past torque wrench "break" point

- a. Cleaning connectors with alcohol shall only be done with the DC power cord removed, in a well-ventilated area, and with the power to the FieldFox turned OFF. Allow all residual alcohol moisture to evaporate, and the fumes to dissipate prior to energizing the instrument.

B: Specifications/Data Sheet

To ensure the highest accuracy and consistency, the FieldFox Specifications are now stored ONLY at:

<http://literature.cdn.keysight.com/litweb/pdf/5990-9783EN.pdf>

C: Instrument Calibration

Over time, the active components in the FieldFox age and the performance may degrade or drift. To ensure that the FieldFox is performing to the published specifications, you should have an instrument calibration performed periodically.

How Often Should Calibrate My Instrument?

You determine the calibration period which best meets your requirements. However, a 12 month calibration cycle is appropriate for most users.

There are two things to consider: performance drift and connector wear.

The instrument specifications are set to consider the performance drift that may occur over a 12 month period. Therefore, getting the instrument calibrated at 12 month intervals ensures that the analyzer maintains performance within the operating specifications. If you need the analyzer to maintain more consistent operation, you may want to have the instrument calibrated more often.

Connector wear is a bigger factor and depends on the number of connections that are made. The test ports become noticeably worn after 500 to 700 connections. This could represent about 12 months with average use. With more frequent connections, the calibration cycle should be sooner. You can extend the time between calibrations and thereby save money by using connector savers and by performing proper Connector Care. Learn more in [“Connector Care Review” on page 537](#).

How do I Get an Instrument Calibration?

To get your Keysight instrument calibrated, send it to one of the Keysight Technologies service centers. Please visit this website to learn how:

www.keysight.com/find/calibration.

What Are My Choices of Instrument Calibration?

The following types of instrument calibration are available from Keysight Technologies service center:

Keysight Calibration	Includes the test data from the calibration and the certificate of calibration, stating the instrument has been calibrated and is operating within the published specifications.
ANSI Z540 Calibration	Includes the test data from the calibration and the certificate of calibration, stating the instrument has been calibrated using a process in compliance with ANSI Z540.1 and is operating within the published specifications
ISO 17025 Calibration	Includes the test data from the calibration and the certificate of calibration, stating the instrument has been calibrated using a process in compliance with ISO 17025 and is operating within the published specifications. Chapter 3, "CAT (Cable and Antenna Test) Mode."

D: Korean Battery Safety Translation

외장 배터리에 대한 안전 사항

배터리 관리:

부풀어오름 (스웰링), 배터리 셀의 균열, 유체의 누수와 같은 상태 악화의 증상이 나타나는지, 주기적으로 배터리를 검사하십시오. 상태가 악화될 경우, 배터리를 교체하고 올바르게 배터리를 처분하십시오. 20-7 페이지의 “리튬 이온 배터리 폐기처분법”을 참조하십시오. 상태가 나쁜 배터리를 사용하여 구동할 경우 FieldFox에 악영향을 끼칠 수 있습니다. 더 알아보려면 21-6 페이지의 “배터리 관련”을 참조하십시오.

리튬 이온 배터리 폐기처분법:

적절한 재충전을 거쳤음에도 충전 용량이 대폭 감소한 경우, 배터리를 교체하는 것이 권장됩니다. 리튬 이온 배터리는 적절한 방법으로 폐기되어야 합니다. 배터리의 환경 친화적 수거, 재활용, 폐기 처분에 관련된 내용에 대해 알아보려면 지역 폐기물 관리 시설에 문의하십시오. 국가별로 적용되는 규제가 다를 수 있습니다. 거주지 규정에 따라 배터리를 처분하십시오. Keysight Technologies에서는 미합중국과 캐나다 지역에서 Rechargeable Battery Recycling Corporation (RBRC)를 경유하여 무료로 편리한 배터리 재활용 옵션을 제공하고 있습니다. 근처 재활용 시설의 위치를 알아보려면 877-2-RECYCLE (877.273.2925)로 전화하시거나 인터넷을 통해 <http://www.call2recycle.org/> RBRC에 문의하십시오.

배터리 관련:

리튬 배터리 팩은 잘못된 환경에 노출될 경우 발열이 발생하거나, 폭발하거나, 발화하여 심각한 상해를 발생시킬 수 있습니다. 다음 안전 경고를 주의깊게 따라 주십시오.

경고:

리튬 이온 배터리:

- 고온 (>70°C) 또는 화재에 노출되어서는 안 됩니다.
- 어린이들이 취급하지 않도록 해 주십시오.
- 함선되지 않도록 해 주십시오.
- Keysight에서 검증한 리튬 이온 배터리로만 교환되어야 합니다.
- 부적절하게 교환하거나 충전된 경우, 폭발의 위험이 있습니다.

- | 배터리의 음극과 양극을 금속제 물질(전선 등)으로 서로 연결하지 마십시오.
- | 배터리를 목걸이, 머리핀 또는 다른 금속제 물질과 같이 보관하거나 운반하지 마십시오.
- | 배터리에 직접적으로 납땜하지 마십시오.
- | 배터리를 물이나 소금물에 노출하거나, 배터리가 습기에 노출되게 하지 마십시오.
- | 배터리를 분해하거나 개조하지 마십시오. 배터리에는 안전 보호 장치가 장착되어 있으며, 이것이 손상될 경우 배터리 발열, 폭발, 발화의 원인이 됩니다.
- | 배터리를 직사광선에 노출하거나, 더운 날씨에 배터리를 차 내부에 보관하지 마십시오. 배터리가 발열, 폭발, 또는 발화할 수 있습니다. 이러한 방식으로 배터리를 사용하면 또한 성능의 감소와 생명 주기의 단축이 발생할 수 있습니다.
- | 배터리가 올바르게 않게 교체된 경우, 폭발의 위험이 있습니다.
- | 동일하거나 일치하는 종류의 배터리로만 교체할 것을 권장합니다.
- | 배터리를 폐기할 때에는 제조사의 지시에 따르십시오. 내부에서 배터리를 충전할 경우 FieldFox의 전원이 꺼져 있는 상태라 할지라도 FieldFox에서 발열이 발생할 수 있습니다.
- | 적절한 환기는 허용됩니다.
- | 이 배터리를 FieldFox 또는 외장 배터리 충전기(N9910X-872) 이외의 장비를 사용하여 방전하지 마십시오.
- | 배터리가 기술되어 있지 않은 장비에 사용될 경우, 배터리가 손상되거나 수명이 단축될 가능성이 있습니다. 해당 장비가 전류를 비정상적으로 흘려보낼 경우, 배터리에 발열이 발생하거나, 폭발하거나, 발화하여 심각한 부상을 입힐 수 있습니다.

배터리: 안전한 사용 및 처리

FieldFox 배터리를 안전하게 사용하고 처리하는 방법에 대해 알아보려면, 제조사에서 제공하는 배터리의 물질안전보건자료(MSDS)를 참조하십시오:

<http://na.support.keysight.com/fieldfox/help/Reference/MSDS.htm>

E: Keysight Software End-User Licensing Agreement
(EULA)

KEYSIGHT SOFTWARE END-USER LICENSE AGREEMENT

ATTENTION: THIS SOFTWARE IS SUBJECT TO THE END-USER LICENSE AGREEMENT (“EULA”) SET FORTH BELOW. TO INSTALL OR USE THE SOFTWARE, YOU MUST FIRST AGREE TO THE EULA BELOW. IF THE EULA IS PRESENTED TO YOU ELECTRONICALLY AND IF YOU HAVE READ, UNDERSTAND AND AGREE TO BE BOUND BY THE TERMS OF THE EULA, CLICK “AGREE”. IF THE EULA IS PRESENTED TO YOU IN A HARD COPY FORMAT, BY POWERING ON AND USING THE INSTRUMENT OR MACHINE, YOU AGREE THAT YOU HAVE READ, UNDERSTAND AND AGREE TO BE BOUND BY THE TERMS OF THE EULA.

1. Translations. Translations of this EULA are found at: www.keysight.com/find/sweula.

2. Software. “Software” means a single copy of one or more computer programs, whether stand-alone or bundled with other products, and related documentation, including any online or electronic documentation, data and license files.

3. License Grant. Keysight Technologies, Inc. (“Keysight”) grants you a limited, non-exclusive license to use, in accordance with one of the license types listed below, the Software, for the Term (as defined below), subject to the terms and conditions herein:

3.1 Node Locked (“fixed”) license. If you have obtained a Node Locked license, you may install one copy of the Software on one instrument or machine and use the Software only on that instrument or machine for your internal business use.

3.2 Transportable license. If you have obtained a Transportable license, you may use one copy of the Software on any single instrument or machine at one time for your internal business use. You may move such Software to a different instrument or machine for your internal business use provided only one copy is in use at any one time.

3.3 Floating (“concurrent use”) license. If you have obtained a Floating license, you may install one or more copies of the Software on any instrument or machine within your internal computer network for your internal business use provided the total number of users who are accessing and/or using any of the Software at the same time does not exceed the maximum number of licensed users.

You may find the type of license you obtained, the Term of your license, and the licensed number of users (if applicable) in documentation associated with the Software. “Term” means either a set amount of time (an expiring license) or a Perpetual license. “Perpetual” means the lifetime of the instrument or machine. In the absence of documentation specifying the applicable license, you have a fixed license with a Perpetual Term.

4. License Restrictions.

4.1 No Copies. You may not make copies or adaptations of the Software except for backup and archival purposes or when copying or adaptation is an essential step in the licensed use of the Software including correction of errors. You must reproduce all copyright and other legal notices in the original Software on all permitted copies or adaptations. You may not copy the Software onto any public or distributed network.

4.2 No Reverse Engineering. You may not decompile, reverse engineer, disassemble, attempt to derive the source code of, decrypt, modify, or create derivative works of the Software (except to the extent any foregoing restriction is prohibited by applicable mandatory law or by licensing terms governing the use of open source components that may be included with the Software).

4.3 No Circumvention. The Software may include technological measures, whether in the Software or in bundled hardware or both, that are designed to prevent or detect unlicensed use of the Software. Circumvention of these technological measures is prohibited, except as expressly permitted by applicable law. Any attempt to circumvent technological measures may render the Software or certain features unusable or unstable, and may prevent you from updating or upgrading the Software.

4.4 Limited Use. Notwithstanding anything to the contrary herein, you may not use Software to make or distribute your own or a third party’s application, a principal purpose of which, as reasonably determined by Keysight, is to perform the same or similar functions as the Software or which replaces any component of the Software.

5. Third Party Software.

5.1 General. The Software may contain third party software subject to third party notices and/or additional terms and conditions. Such required third party software notices and/or additional terms and conditions can be found in the documentation associated with the Software. You have all rights necessary to use the Software as permitted in Sections 3 and 4. To the extent your use exceeds the grants and restrictions in Sections 3 and 4, third party license terms take precedence and will apply.

5.2 Separation of Components. Except as required by included open source software licenses, the Software is licensed as a single product and its component parts may not be separated for any other use except to the extent expressly otherwise licensed.

5.3 Additional Terms for Microsoft Windows Embedded Software. Microsoft Windows for Embedded Systems may be included with the instrument or machine. If so, your grant under this license prohibits accessing or using any Desktop Functions other than through, in support of and operating as part of the software and/or functions that provide the primary functionality of the instrument or machine.

“Desktop Functions” means consumer or business tasks or processes, including word processing, spreadsheets, database, scheduling and personal finance.

6. Upgrades. This EULA does not entitle you to receive upgrades, updates or technical support. Upgrades, updates and technical support services may be purchased separately. The terms of this EULA govern any software updates or upgrades provided by Keysight unless replaced and/or supplement Software is accompanied by a separate license agreement in which case the terms of that license agreement will govern. Any comments, suggestions, improvements or other communications from you to Keysight regarding the Software (“Feedback”) may be used by Keysight without compensation or attribution.

7. Ownership. The Software and all copies thereof are licensed and not sold to you. The Software and all copies thereof are owned and copyrighted by Keysight or its third party suppliers and protected by copyright laws and other intellectual property laws and treaties. Keysight and its third party suppliers retain all right, title and interest in the Software. Keysight and its third party suppliers may protect their respective rights in the Software in the event of any violation of this EULA.

8. High Risk Activities. The Software is not specifically written, designed, manufactured or intended for use in the planning, construction, maintenance or direct operation of a nuclear facility, nor for use in on line control or fail safe operation of aircraft navigation, control or communication systems, weapon systems or direct life support systems.

This information is subject to change without notice. © Keysight Technologies, 2013 – 2015 Published in USA, February 1, 2017 www.keysight.com

Keysight Software End-User Licensing Agreement (EULA)

5991-3402 (supersedes 5991-3402-14Dec2015)

9. Transfer. You may not sell or otherwise transfer the Software except as expressly specified below. Licensed users are Licensee's employees, authorized agents, representatives, and subcontractors acting on behalf of Licensee for Licensee's internal business use. You may not rent, lease, lend, allow for commercial time sharing, or otherwise permit access to the Software to any unlicensed third party or entity. You may not transfer the license granted to you here unless you obtain Keysight's prior written authorization, deliver all copies of the Software to the transferee along with this EULA, and pay any applicable fees. For all transfers, the transferee must accept this EULA as a condition to any transfer and your license to use the Software will terminate upon transfer. Entitlement to receive technical support services for the Software may be transferred provided that you obtain Keysight's prior written consent and pay any applicable fees. This section regarding transfer applies only to the extent permissible under applicable mandatory laws.

10. Term and Termination. This EULA shall continue for the Term unless terminated by Keysight as provided herein. Keysight may terminate this license upon notice for breach of this EULA. Upon expiration or termination, you must immediately destroy all copies of the Software.

11. Export Requirements. If you export, re-export or import Software, technology or technical data licensed hereunder, you assume responsibility for complying with applicable laws and regulations and for obtaining required export and import authorizations. Keysight may terminate this license immediately if you are in violation of any applicable laws or regulations.

12. Audit and Security Mechanisms. You agree that Keysight may restrict the number of copies you are using by security servers, security keys/modules, a hardware lock device, license administration software, a license authorization key to control access to the Software or other security mechanism and you consent to such use. You may not take any steps to avoid or defeat the purpose of any such measures. Use of the Software without the lock device or authorization key provided by Keysight is prohibited. Keysight may take all legal steps to eliminate unlicensed use and piracy of their Software. In this context, the Software may include a security mechanism to detect installation or use of unlicensed copies of the Software, and collect and transmit data about suspected unlicensed copies. Data collected does not include any customer data created with the Software. By using the Software, you consent to such detection and collection of data, as well as its transmission and use if suspected unlicensed copies are detected. Upon reasonable notice and reasonable suspicion of unlicensed use, Keysight may conduct during normal business hours (with the auditor's costs being at Keysight's expense) an audit of your compliance with this EULA. If an audit reveals underpayments then you will pay to Keysight such underpayments. If underpayments discovered exceed five (5) percent of the contract price, you will reimburse Keysight for the auditor costs.

13. U.S. Government Rights. The Software is "commercial computer software," as defined by Federal Acquisition Regulation ("FAR") 2.101. Pursuant to FAR 12.212 and 27.405-3 and Department of Defense FAR Supplement ("DFARS") 227.7202, the U.S. government acquires commercial computer software under the same terms by which the software is customarily provided to the public. Accordingly, Keysight provides the Software to U.S. government customers under its standard commercial license, which is embodied in this EULA. The license set forth in this EULA represents the exclusive authority by which the U.S. government may use, modify, distribute, or disclose the Software. This EULA and the license set forth herein, does not require or permit, among other things, that Keysight: (1) Furnish technical information related to commercial computer software or commercial computer software documentation that is not customarily provided to the public; or (2) Relinquish to, or otherwise provide, the government rights in excess of these rights customarily provided to the public to use, modify, reproduce, release, perform, display, or disclose commercial computer software or commercial computer software documentation. If you are a U.S. government customer, you acknowledge that you have reviewed the Software and the terms of this EULA and agree that the license provided for herein is consistent with Federal law and otherwise satisfies the U.S. government needs. In addition, if you are a U.S. government customer you agree that this EULA reflects the entirety of the terms of Keysight's customary commercial license applicable to U.S. government customers. No additional government requirements beyond those set forth in this EULA shall apply, except to the extent that those terms, rights, or licenses are explicitly required from all providers of commercial computer software pursuant to the FAR and the DFARS and are set forth specifically in writing elsewhere in this EULA. Keysight shall be under no obligation to update, revise or otherwise modify the Software.

14. WARRANTY. TO THE EXTENT ALLOWED BY APPLICABLE MANDATORY LAW, AND EXCEPT TO THE EXTENT KEYSIGHT HAS PROVIDED A SPECIFIC WRITTEN WARRANTY APPLICABLE TO THIS SOFTWARE, THIS SOFTWARE IS PROVIDED TO YOU "AS IS" WITHOUT WARRANTIES OR CONDITIONS OF ANY KIND, WHETHER ORAL OR WRITTEN, EXPRESS OR IMPLIED. KEYSIGHT, ON BEHALF OF ITSELF ITS SUBSIDIARIES, AFFILIATES AND SUPPLIERS SPECIFICALLY DISCLAIMS ANY IMPLIED WARRANTIES OR CONDITIONS OF MERCHANTABILITY, SATISFACTORY QUALITY, NON-INFRINGEMENT AND FITNESS FOR A PARTICULAR PURPOSE. SHOULD THE SOFTWARE PROVE DEFECTIVE, YOU ASSUME THE ENTIRE RISK AND COST RESULTING FROM OR RELATING TO THE DEFECT. SOME JURISDICTIONS DO NOT ALLOW EXCLUSIONS OF IMPLIED WARRANTIES OR CONDITIONS, SO THE ABOVE EXCLUSION MAY NOT APPLY TO YOU. YOU MAY HAVE OTHER RIGHTS THAT VARY ACCORDING TO APPLICABLE MANDATORY LAW.

15. LIMITATION OF LIABILITY. TO THE EXTENT ALLOWED BY APPLICABLE MANDATORY LAW, IN NO EVENT WILL KEYSIGHT OR ITS SUBSIDIARIES, AFFILIATES OR SUPPLIERS BE LIABLE FOR ANY SPECIAL, INCIDENTAL, CONSEQUENTIAL OR OTHER DAMAGES (INCLUDING DOWNTIME COSTS, LOSS OF DATA, RESTORATION COSTS OR LOST PROFITS) REGARDLESS OF WHETHER SUCH CLAIMS ARE BASED ON CONTRACT, TORT, WARRANTY OR ANY OTHER LEGAL THEORY, EVEN IF ADVISED OF THE POSSIBILITY OF SUCH DAMAGES. YOUR USE OF THE SOFTWARE IS ENTIRELY AT YOUR OWN RISK. NOTWITHSTANDING THE FOREGOING, IN THE EVENT THE SOFTWARE IS PROVIDED TO YOU AT NO CHARGE, KEYSIGHT OR ITS SUBSIDIARIES, AFFILIATES OR SUPPLIERS SHALL HAVE NO LIABILITY FOR DIRECT DAMAGES. SOME JURISDICTIONS DO NOT ALLOW THE EXCLUSION OR LIMITATION OF LIABILITY FOR DAMAGES, SO THE ABOVE LIMITATION MAY NOT APPLY TO YOU.

16. Applicable Law. Disputes arising in connection with this EULA will be governed by the laws of the United States and of the State of California, without regard to choice of law provisions. The United Nations Convention for Contracts for the International Sale of Goods will not apply to this EULA.

17. Unenforceability. To the extent that any provision of this EULA is determined to be illegal or unenforceable, the remainder of this EULA will remain in full force and effect.

18. Entire Agreement. Certain program, data and license files in the Software may be subject to supplemental license terms found in the documentation associated with the Software or directly in the files to which the supplemental terms apply. This EULA constitutes the entire

Keysight Software End-User Licensing Agreement (EULA)

agreements between the parties, whether oral or written, except if you have a separate written, valid agreement that is executed by both parties and the terms of such agreement conflict with the terms contained herein, in which case the terms of such agreement apply. This EULA may not be changed except by an amendment signed by an authorized representative of each party.

This information is subject to change without notice. © Keysight Technologies, 2013 – 2015 Published in USA, February 1, 2017 www.keysight.com
5991-3402 (supersedes 5991-3402-14Dec2015)

This information is subject to change without notice. © Keysight Technologies, 2013 – 2015 Published in USA, February 1, 2017 www.keysight.com

Index

Symbols

, 533

Numerics

1-port cable loss measurements

CAT mode, 53

1-port cable loss, CAT mode, 54

1-Port Cable Trimming VVM Measurements, 341

1-Port Cable Trimming, VVM measurements, 333

2-port insertion loss measurements, 341

CAT mode, 55

2-port insertion loss measurements, CAT mode, 55

2-port transmission measurements

VVM mode, 343

2-port transmission measurements, VVM mode, 343

89600 VSA software, 263

A

ABC keyboard, 477

AC/DC adapter, 521, 533

power requirements, 25 using, 515

accessories, 22

Adjacent Channel Power (ACPR), 196

Alias Faults, 67, 80

align all now,alignments, 179

alignments,align all now, 179

alignments,individual, 177

alignments,overview, 177

all about markers, 438

AM FM Tune & Listen, 159

AM/FM Metrics, error messages, 367

AM/FM Metrics, Option 355, 357

AM/FM Metrics,error messages, 367

Amplitude Alignment, 182

InstAlign, 221

IQA, 259, 415

RF Burst, 182

Antenna Corrections, 154, 156

appendix B, 537, 541

attenuation, 152, 153, 207, 208, 252

Audio Beep, 189

Average Type, 176, 220

Averaging

VVM, 338

averaging, 48, 96, 460

VVM, 338

avoid overpowering, 32

B

Band Power Marker IQA, 255

Band Power Marker SA mode, 187, 255, 256, 258, 452

Band Span Marker IQA, 256

bandpass mode, 61, 62

battery

care, 518

charge status, viewing, 513

charge status,viewing, 464, 513

charging, 27

external, 517

internal, 515

disposal, 519

gauge, 514

icons, 513

installing, 26

LED, 517

markings, 531

maximizing life, 518

protective functions, 526

safe handling, 528

saver, 472

service diagnostics, 514

viewing charge status, 26

Big Marker IStates, 103

big marker states, 103

bridge cancellation

measurements, VVM

mode, 343

brightness

display, 467

Built-in Power Meter, 293

C

Cable (Correction) Specifications

DTF, 63, 75

cable and antenna test See CAT

cable loss measurements, 53, 54

cable specifications, DTF, 64

Cal On ?, 138

Calculated DTF values, 67, 79

calibration

Cal On ?, 138

CAT and NA modes, 119

noise figure, 425

type, 132

verifying integrity, 140

Calibration Type, 132

Calibration Wizard

Wizard,calibration, 425

CalReady, 121

properties, 139

CalReady Properties, 139

Capture Data IQA, 240

care of the battery, 518

CAT mode

1-port cable loss measurements, 53

2-port insertion loss measurements, 55

calibration, 119

DTF settings, 60, 72, 85, 109, 239

- return loss measurements, 53
 - settings, 45, 289, 290
 - CAT mode measurements, 287
 - certification statements, 534
 - Channel Power (CHP), 192
 - channel scanner, option
 - 312, 371
 - Channel Selection, 149
 - charge status, viewing, 464, 513
 - charging the battery
 - externally, 517
 - internally, 515
 - cleaning the screen, 35
 - colors, display, 467
 - compliance statements, 534
 - compressed measurement, 153, 154, 209
 - Compressed SA
 - Measurements, 153, 209
 - connector care review, 537
 - considerations, safety, 521
 - Contacting Keysight, 5
 - Continuous Peak Search
 - Marker IQA, 258
 - control, temperature, 29
 - Couple Markers IQA, 256
 - Coupled Frequency, 52, 62
 - Coupled Markers, 441
 - cursor moving, 509
 - cursor, moving, 501, 509, 511
- D**
- data analysis features, 437, 497
 - data indicator (*), old, 190
 - data indicator, old (*), 190
 - Date and Time Setting, 487
 - Date and Time setting, 475
 - date/time setting, 475, 486
 - declaration of conformity, 534
 - delta marker, 439, 440
 - delta markers, 439
 - Detection Method, 184, 219
 - detection method, 184, 219
 - display
 - brightness, 467
 - colors, 467
 - front panel, 39
 - preferences, 471
 - settings, 467
 - display "live" and memory traces, 331
- Display Resolution
 - VVM, 336
 - disposal of battery, 519
 - dissipate static charge, 32
 - DTF
 - measurements, 57, 58
 - settings, 60, 72, 85, 109, 239
 - start and stop distance, 58
 - DTF Measurement, 60, 72
 - DTF settings, 60
 - DTF Start and Stop
 - Distance, 61, 73
 - Dynamic Range, 105
 - dynamic range, 105
- E**
- ECal, 128
 - Edit a Cable File, 64
 - DTF, 64, 76
 - edit keywords, 509
 - edit, enable and disable the
 - current prefix, 509, 511
 - edit, enable and disable the
 - current suffix, 509, 510
 - Electrical Delay, 95
 - Enhanced Response
 - Optimization, 137
 - Erase User Data, 493
 - error
 - meas UNCAL, 164, 190
 - red flashing LED, external battery charger, 517
 - red red flashing LED, external battery charger, 517
 - systematic, 120
 - error messages, AM/FM Metrics, 367
 - ERTA, 347
 - ESD, 529
 - Event Log, 493
 - external frequency
 - reference, 484
 - External Gain, 152, 207
 - External triggering, 99, 169, 213
 - external triggering, 169, 213
 - external zeroing, 301
- F**
- features, overview, 21
- FFT Gating, 172
 - Field Strength
 - Measurements, 154
 - File Management, 497
 - file management, 497
 - files
 - managing, 506
 - prefixes, 509, 511
 - suffixes, 509
 - FM Tune & Listen, 159
 - FM tune and listen, 38
 - folders, 508
 - Format
 - NA Mode, 92
 - format, NA mode, 92
 - FoxTrot, 347
 - FreqMaskTrigger, 281
 - frequency
 - context, setting, 411
 - external reference, 484
 - mode, DTF, 61
 - range, NA mode, 93
 - range, setting, 47, 411
 - range, step size, 147
 - step size, 147
 - Frequency Counter at SA
 - Marker, 188, 452
 - Frequency Offset Using Power
 - Sensor, 307
 - Frequency Range
 - NA Mode, 93
 - front panel, 33
 - Full Screen Mode, 469
- G**
- Gating, 116
 - gating, 116
 - Gating, FFT, 172
 - gauge, battery, 514
 - getting started information, 25
 - GPS, 475, 480
 - group delay, 92, 93
- H**
- high-temperature protection, 28
 - hold, 464
 - how to
 - change frequency step size, 146,

- 147, 205
- units to feet, 67, 79
- check for a compressed measurement, 154, 209
- control the preamp, 153, 208, 253
- create
 - delta marker, 440
 - markers, 438
- edit keywords, 509
- edit, enable and disable the current prefix, 511
- enter
 - numeric values, 41
- make
 - 1-port cable loss measurement, 5
 - 3, 54
 - 2-port insertion loss measurement, 5
 - 5
 - DTF measurements, 58, 70
- manage files, 506
- measure return loss, 53
- monitor the internal FieldFox temperature, 28
- move
 - cursor, 501, 511
 - reference marker, 440
- name files, 500
- perform
 - O, S, L cal, 125
 - O,S, L cal, 125
 - single sweep while in Hold, 464
- preset, 465
- recall an *.sta file, 502
- save
 - display settings as preferences, 471
 - file, 498
- select
 - CAT mode, 45, 290
 - CAT mode measurements, 45, 290
 - NA formats, 92
 - RTSA mode, 205
- SA mode, 146, 205
- set
 - attenuation, 152, 153, 207, 208, 252
 - bandpass mode ON, 62
 - date and time, 486
 - frequency context, 411
 - frequency range, 47, 146, 205, 411
 - output power, 51, 100, 338
 - power meter display units, 304
 - res BW, 163, 212, 415
 - resolution, 50, 98
 - scale, 47, 460
 - sweep time, 50
 - sweep type, 49, 98
 - trace averaging, 48, 460, 461
 - video BW, 164
- use
 - external reference, 484
- view and change Quick Settings, 90
- view and change quick settings, 90
- http
 - //literature.cdn.keysight.com/litweb/pdf/5991-4913EN.pdf, 364
- I
 - icons, battery, 513
 - IF Bandwidth
 - NA Mode, 97
 - VVM, 337
 - IF bandwidth
 - NA Mode, 97
 - IF Output, 165
 - IF output, 165
 - indicator (*), old data, 190
 - individual,alignments, 177
 - initial use, preparing for, 25
 - input voltages and power, maximum, 32
 - insertion loss measurements, 55
 - InstAlign, 182, 221, 259, 415
- installing battery, 26
- Interference Analyzer, 269
- interference rejection, 51, 52
- Interpolation, 138
- Interval Power Marker, 187, 255, 256, 258
- Interval Power Marker IQA, 255
- Interval Span Marker IQA, 256
- IQ Analyzer, 235
- IQA
 - markers,using, 254
 - measurement,parameters, 24
 - 3
 - measurements,about, 238
 - measurements,how to make, 239
 - trace display states, 259
- IQA mode settings, 239
- IQA, Captrure Data, 240
- Isolation, 135
- K
 - Keyboard,ABC, 477
 - Keyboard,Qwerty, 477
 - keywords, 509
- L
 - LAN Settings, 488
 - language, settings, 472
 - latest information, where to find, 23
- LED
 - battery, 517
 - on/off settings, 28
- Licensing, 479
- Limit Lines, 453
- Limit lines, 453
 - saving and recalling, 456
- lithium-ion battery, installing, 26
- M
 - Magnitude Offset, 94
 - magnitude offset, 94
 - Manage Files, 506
 - Manage Folders, 508
 - managing files, 506

- folders, 508
- manuals, 23
- marker
 - table, 440
- markers, 438
 - Coupled (NA Mode), 441
 - creating, 438
 - delta, 439
 - moving, 438
 - search function, 442, 444
 - table, 440
 - trace, 442
 - trace (CAT & NA Mode), 442
 - trace (SA Mode), 442
- markers,using
 - IQA, 254
- markings
 - battery, 531
 - FieldFox, 530
 - packaging, 533
- math
 - operations, 459
- maximizing battery life, 518
- maximum input voltage and power, 32
- maximum input voltages and power, 32
- Meas UNCAL error, 190
- meas UNCAL error, 164
- measurement selection, IQA Mode, 235
- measurement selection, NA Mode, 83
- measurement,parameters
 - IQA, 243
- Measurements
 - IQA, 238
- measurements
 - 1-port cable loss
 - measurements, CAT mode, 53
 - 1-port cable loss, CAT mode, 53
 - 2-port insertion loss, CAT mode, 55
 - bridge cancellation, VVM mode, 343
 - compressed, 153, 154, 209
 - return loss, 53
 - selection, 45, 290
 - selection, reflection, 290
- measurements,about
 - IQA, 238
- measurments,how to make
 - IQA, 239
- mini-USB port, sending SCPI commands, 495
- Mixed-Mode S-Parameters, 86
- mixed-mode S-parameters, 86
- mode, 263
 - IQA, 235
 - NA, 83
 - power meter, 293
 - RTSA, 205
 - SA, 143, 146, 203, 269, 287, 297, 307
- temperature control, 29
- VVM, 333
- move
 - cursor, 501, 509, 511
 - reference marker, 440
- moving the cursor, 501, 509, 511
- multiplier abbreviations, 41
- multipliers, 41
- Multi-Trace Configurations, 89
- multi-trace configurations, 89
- N
- NA Factory Cal, 493
- NA mode
 - calibration, 119
 - settings, 85, 88, 90
- name files, 500
- network analyzer, 83
- noise figure, calibration, 425
- noise figure, option 356, 387
- Noise Marker IQA, 254
- normalization, 131
- normalize, 131
- numeric values, 41
- numeric values, entering, 41
- O
- O, S, L cal, 125
- O, S, L calibration, 125
- Occupied Bandwidth, 194
- old data indicator (*), 190
- Opt 010, 107
- option
 - 010, 107
 - 215, 69
- option 312 , channel scanner, 371
- Option 355 AM/FM Metrics, 357
- option 356, noise figure, 387
- options
 - installing, 479
- Output Power
 - NA Mode, 100, 337
- output power, 51, 100, 338
- overpowering, avoid, 32
- overview, 21
- overview,alignments, 177
- P
- packaging markings, 533
- panel, front, 33
- panel, left side, 38
- panel, right side, 36
- panel, top, 36
- Parameter Conversion, 87
- peak
 - criteria, 449
 - excursion, 449, 450
 - threshold, 449
- perform
 - single sweep while in Hold, 464
- Phase Offset, 95
- Playback Configuration, 229, 232, 279, 283
- Points SA mode, 174, 217, 414
- points, RTSA mode, 217
- points, SA mode, 174, 414
- Port Extensions, 101
- power meter mode, 293
- power requirements, 25
- power requirements for the AC/DC adapter, 25
- power sensor input, 32, 37
- Power Spectral Density, 193
- power, maximum, 32
- Preferences, 469
- preferences, 469
- prefixes for file names, 509, 511
- preparing for initial use, 25
- preset, 465
- preset settings, 465
- Printing, 512
- printing, 512
- protection, high temperature, 28

protective functions of the
battery, 514
Pulse Measurements, 317

Q

Quick Settings, 90
quick settings, 46
QuickCal, 123
Qwerty keyboard, 477

R

Radio Standard, 148
real-time spectrum analyzer
mode, 203
recall an *.sta file, 502
recalling files, 502
Receiver Measurements, 88
Record Source, 231, 282
Record/Playback, 225, 275
Record/Playback, RTSA, 225
Record/Playback, SA, 275
Recording Configuration, 230,
279
reference marker, 440, 451
reference, external
frequency, 484
Reflection Mode, 287
remote server, 263
resolution, 39, 50
NA Mode, 98
Resolution Bandwidth SA
mode, 163, 212, 415
resolution bandwidth, NF
mode, 415
resolution bandwidth, RTSA
mode, 212
resolution bandwidth, SA
mode, 163
Resolution, NA mode, 98
Response Cals, 130
response calcs, 130
Restart, 174, 216, 414
restart, 174, 216, 414
return loss measurements, CAT
mode, 53
review connector care, 42

reviewconnector care, 537
RRC Weighting, 200
RTSA, 203
RTSA mode
settings, 205
units, 206
RTSA, Spectrogram
Display, 223
RTSA, Record/Playback, 225
RTSA, Spectrogram
Display, 223
RTSA, spectrogram display, 223

S

S11 measurements, NA
mode, 85, 88
SA mode
settings, 146, 205, 223, 270
units, 151
SA Mode Units, 151, 206
SA, Record/Playback, 275
SA, spectrogram display, 270
Safety Considerations, 521
save
display setting as
preferences, 470
file, 498
save and recalling files, 498
Save Preferences, 470, 471
Scale Settings
NA Mode, 93
scale settings, NA mode, 93
scale, setting, 47, 460
screen cleaning, 35
screen front panel, 39
Security Level, 486
select
language, 472
sending SCPI commands,
mini-USB port, 495
service diagnostics, 493
Sessions, 225, 275
set
date and time, 475
display colors, 467
display units, 304
output power, 337

settings

CAT mode, 45, 289, 290
DTF, 60, 72, 85, 109, 239
DTF mode, 60
language, 471, 472
preset, 465
RTSA mode, 205
SA mode, 146, 205, 223, 270
VVM mode, 336
smoothing, 49
Source Control with USB
Power Meter, 302
S-parameters, 85
Spectrogram Display, 223, 270
Spectrogram Display,
RTSA, 223
Spectrogram Display, RTSA, 223
spectrogram display, RTSA, 223
spectrogram display, SA, 270
spectrum analyzer mode, 143,
203, 269, 287, 297, 307
stand-by mode, 27
Startup Mode, 473
static charge, dissipate, 32
Step Detection Mode, 306
suffixes for file names, 509
sweep
acquisition parameter, 164,
166
time, 50
time, NA mode, 99
type, 49, 98
type, SA mode, 164
Sweep Acquisition, 166
sweep acquisition, 166
Sweep Time
NA Mode, 99
Sweep Type
SA Mode, 164
system configuration
settings, 479
System Impedance (Z0), 101
System Settings, 463
systematic, 120

T

TDR, 69



temperature control mode, 29
 Time Domain, 107
 time domain, 69
 Time Zone, 475, 487
 time zone, 475
 time/date setting, 475, 486
 title, editing, 468, 500
 top panel, 36
 trace averaging, setting, 48, 461
 Trace Display States, 175, 218, 259
 trace display states
 IQA, 259
 Trace Math, 315, 458
 Trace Width, 468, 470
 Tracking Generator, 161
 Transform, 107
 transform, 110
 Transform Window, 112
 transform window, 112
 triggering - RTSA mode, 213
 Triggering - SA Mode, 169, 213
 triggering - SA mode, 99, 169
 TRL, 134
 Tune & Listen (AM/FM), 159

U

units, changing, 67, 79
 units, DTF, changing, 67
 USB keyboard, 22
 use
 external reference, 484
 User Preset, 465
 User Tags, 227, 277

V

values
 multipliers, 41
 numeric, 41
 values, multipliers, 41
 VBW, 164
 vector voltmeter, 333
 vector voltmeterSeeVVM, 333
 Velocity Factor, 63, 102
 verifying integrity of
 calibration, 140
 jumper cables, 140
 verifying integrity of calibration
 & jumper cables, 140
 video bandwidth, 164

Video Bandwidth SA mode, 164
 Video triggering, 99, 169, 213
 video triggering, 169, 173, 213
 viewing
 charge status, battery, 464, 513
 installed options, 471, 479
 Volume Control, 466
 volume control, 466
 VSA, 263
 vsa, 263
 VVM Calibration, 339
 VVM mode, 333
 bridge cancellation
 measurements, 343
 settings, 336
 VVM mode, settings, 336

W

Waterfall Display, 270, 273
 Waveguide Calibrations, 135
 where to find the latest
 information, 23
 Window Settings
 DTF, 66, 78
 window settings, DTF, 66

Z

zero span, 167, 168
 Zeroing VVM mode, 339
 zeroing, external, 301
 zeroing, VVM mode, 339



This information is subject to change without notice.

© Keysight Technologies 2014-2018

Edition 4, May 08, 2018



N9927-90001

www.keysight.com