

Low Noise Amplifier

ZX60-P105LN+

50Ω

40 to 2600 MHz

The Big Deal

- Flat Gain, ± 0.25 dB typ.
- High Dynamic Range



Case Style: GC957

Product Overview

The ZX60-P105LN+ (RoHS compliant) uses Mini-Circuits' E-PHEMT technology and offers ultra low Gain Flatness over a broad frequency range and high dynamic range. Housed in a rugged, cost effective unibody chassis, The ZX60-P105LN+ is unconditionally stable and has good input and output return loss over a broad frequency range without the need for external matching components.

Key Features

Feature	Advantages
Ultra Low Noise Figure, 1.9 dB at 2GHz	Outstanding world class noise figure performance.
High IP3 vs. DC power consumption 37 dBm typical at 1 GHz	Combining Low Noise and High IP3 makes this model ideal for use in Low Noise Receiver Front End (RFE)
Max. Input Power, +23 dBm	Ruggedized design operates to high input powers often seen at receiver inputs.
Very Small Size, 0.75" x 0.75"	The unique unibody size and construction enable the ZX60-P105LN+ to be used in extremely compact connectorized applications.

Notes

A. Performance and quality attributes and conditions not expressly stated in this specification document are intended to be excluded and do not form a part of this specification document.

B. Electrical specifications and performance data contained in this specification document are based on Mini-Circuit's applicable established test performance criteria and measurement instructions.

C. The parts covered by this specification document are subject to Mini-Circuits standard limited warranty and terms and conditions (collectively, "Standard Terms"); Purchasers of this part are entitled to the rights and benefits contained therein. For a full statement of the Standard Terms and the exclusive rights and remedies thereunder, please visit Mini-Circuits' website at www.minicircuits.com/MCLStore/terms.jsp



Coaxial Low Noise Amplifier

ZX60-P105LN+

50Ω 40 to 2600 MHz

Features

- excellent gain flatness, ± 0.25 dB over 0.1 - 2.0 GHz
- low noise figure, 1.9 dB typ. at 2 GHz
- gain, 15 dB typ. at 2 GHz
- high IP3, 39 dBm typ. at 0.9 GHz
- unconditionally stable
- protected by US patent 6,790,049

Applications

- base station infrastructure
- portable wireless
- catv & DBS
- MMDS & wireless LAN
- LTE



Case Style: GC957

Connectors	Model	Price	Qty.
SMA	ZX60-P105LN+	\$69.95 ea.	(1-9)

+RoHS Compliant

The +Suffix identifies RoHS Compliance. See our web site for RoHS Compliance methodologies and qualifications

Electrical Specifications at 25°C

Parameter	Condition (MHz)	Min.	Typ.	Max.	Units
Frequency Range		40		2600	MHz
Noise Figure	40		2.3		dB
	500		2.0		
	900		1.9		
	2000		1.9	2.7	
	2600		2.0		
Gain	40		14.4		dB
	500		14.5		
	900	13.8	14.4		
	2000		15.5	16.8	
	2600		15.1		
Gain Flatness	1000 - 2000		± 0.25		dB
Output Power @ 1 dB compression	40		19.5		dBm
	500		21.0		
	900		21.0		
	2000		18.9		
	2600		19.4		
Output IP3	40		34.6		dBm
	500		38.7		
	900		37.4		
	2000		33.6		
	2600		33.2		
Input VSWR	40		2.2		dB
	500		1.2		
	900		1.2		
	2000		1.3		
	2600		1.8		
Output VSWR	40		1.1		dB
	500		1.2		
	900		1.1		
	2000		2.4		
	2600		2.2		
Active Directivity (Isolation-Gain)	40		6.3		dB
	500		4.5		
	900		5.1		
	2000		8.1		
	2600		13.5		
DC Supply Voltage		4.8	5.0	5.2	V
Supply Current		—	63	77	mA

Notes

- Performance and quality attributes and conditions not expressly stated in this specification document are intended to be excluded and do not form a part of this specification document.
- Electrical specifications and performance data contained in this specification document are based on Mini-Circuit's applicable established test performance criteria and measurement instructions.
- The parts covered by this specification document are subject to Mini-Circuits standard limited warranty and terms and conditions (collectively, "Standard Terms"); Purchasers of this part are entitled to the rights and benefits contained therein. For a full statement of the Standard Terms and the exclusive rights and remedies thereunder, please visit Mini-Circuits' website at www.minicircuits.com/MCLStore/terms.jsp



www.minicircuits.com P.O. Box 35166, Brooklyn, NY 11235-0003 (718) 934-4500 sales@minicircuits.com

REV. OR
M141243
ZX60-P105LN+
AF/TH/CP
131007
Page 2 of 4

Maximum Ratings

Parameter	Ratings
Operating Temperature	-40°C to 85°C Case
Storage Temperature	-55°C to 100°C
DC Voltage	5.5 V
Input RF Power (no damage)	+23 dBm (5 minutes max., +17dBm continuous)
Power Consumption	0.47 W

Permanent damage may occur if any of these limits are exceeded.

Outline Drawing

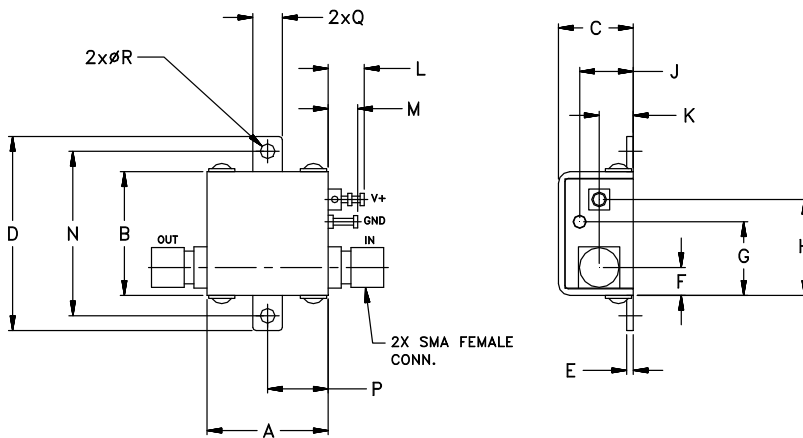

Outline Dimensions (inch / mm)

A	B	C	D	E	F	G	H	J	K	L	M	N	P	Q	R	wt
.74	.75	.46	1.18	.04	.17	.45	.59	.33	.21	.22	.18	1.00	.37	.18	.106	grams
18.80	19.05	11.68	29.97	1.02	4.32	11.43	14.99	8.38	5.33	5.59	4.57	25.40	9.40	4.57	2.69	23.0

Notes

- Performance and quality attributes and conditions not expressly stated in this specification document are intended to be excluded and do not form a part of this specification document.
- Electrical specifications and performance data contained in this specification document are based on Mini-Circuit's applicable established test performance criteria and measurement instructions.
- The parts covered by this specification document are subject to Mini-Circuits standard limited warranty and terms and conditions (collectively, "Standard Terms"); Purchasers of this part are entitled to the rights and benefits contained therein. For a full statement of the Standard Terms and the exclusive rights and remedies thereunder, please visit Mini-Circuits' website at www.minicircuits.com/MCLStore/terms.jsp



FREQUENCY (MHz)	GAIN (dB)	DIRECTIVITY (dB)	VSWR (:1)		POUT at 1dB COMPR. (dBm)	NOISE FIGURE (dB)	OUTPUT IP3 (dBm)
			IN	OUT			
40.00	14.40	6.30	2.19	1.09	19.7	2.3	34.7
200.00	14.32	4.76	1.23	1.13	21.0	2.1	38.4
300.00	14.39	4.58	1.18	1.15	21.2	2.1	39.1
500.00	14.45	4.54	1.18	1.16	21.1	1.9	38.6
600.00	14.45	4.62	1.18	1.15	21.2	1.9	38.4
800.00	14.32	5.00	1.18	1.14	21.0	1.9	37.0
1100.00	14.37	5.43	1.22	1.13	20.7	1.9	36.1
1200.00	14.36	5.62	1.22	1.15	20.1	1.9	35.1
1400.00	14.35	6.08	1.26	1.19	19.8	2.0	34.6
1600.00	14.38	6.60	1.32	1.26	19.5	2.0	34.5
1800.00	14.41	7.24	1.43	1.36	19.3	2.1	34.1
2000.00	14.44	8.14	1.60	1.50	19.0	1.9	33.6
2100.00	14.45	8.73	1.68	1.60	19.1	1.9	33.6
2300.00	14.36	10.44	1.84	1.82	19.1	2.0	33.3
2500.00	14.83	12.22	1.87	1.95	19.3	2.0	33.1
2600.00	14.98	13.50	1.85	2.21	19.5	2.0	33.3

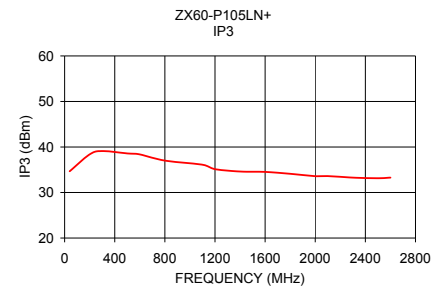
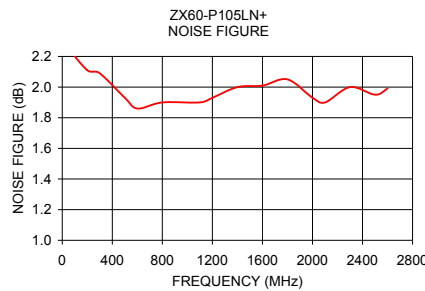
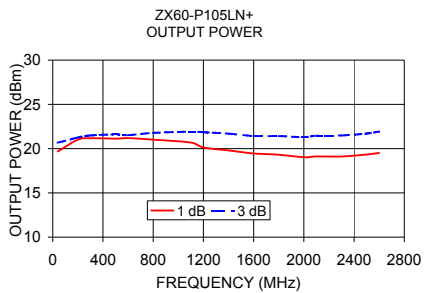
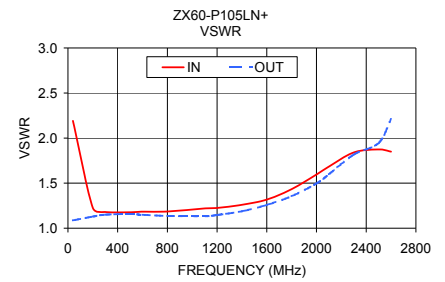
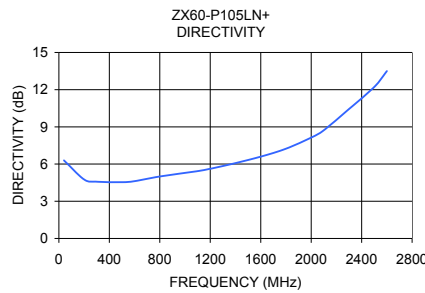
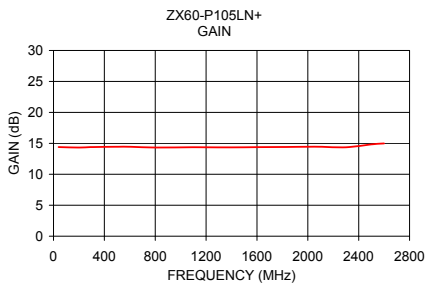

Notes

- A. Performance and quality attributes and conditions not expressly stated in this specification document are intended to be excluded and do not form a part of this specification document.
- B. Electrical specifications and performance data contained in this specification document are based on Mini-Circuits' applicable established test performance criteria and measurement instructions.
- C. The parts covered by this specification document are subject to Mini-Circuits standard limited warranty and terms and conditions (collectively, "Standard Terms"); Purchasers of this part are entitled to the rights and benefits contained therein. For a full statement of the Standard Terms and the exclusive rights and remedies thereunder, please visit Mini-Circuits' website at www.minicircuits.com/MCLStore/terms.jsp

